



Dedicated to innovation in aerospace

NLR-TP-2017-251 | June 2017

Transient modelling of pumped two-phase cooling systems:

Comparison between experiment and simulation with R134a

CUSTOMER: Netherlands Aerospace Centre



NLR – Netherlands Aerospace Centre

Netherlands Aerospace Centre

NLR is a leading international research centre for aerospace. Bolstered by its multidisciplinary expertise and unrivalled research facilities, NLR provides innovative and integral solutions for the complex challenges in the aerospace sector.

NLR's activities span the full spectrum of Research Development Test & Evaluation (RDT & E). Given NLR's specialist knowledge and facilities, companies turn to NLR for validation, verification, qualification, simulation and evaluation. NLR thereby bridges the gap between research and practical applications, while working for both government and industry at home and abroad.

NLR stands for practical and innovative solutions, technical expertise and a long-term design vision. This allows NLR's cutting edge technology to find its way into successful aerospace programs of OEMs, including Airbus, Embraer and Pilatus. NLR contributes to (military) programs, such as ESA's IXV re-entry vehicle, the F-35, the Apache helicopter, and European programs, including SESAR and Clean Sky 2.

Founded in 1919, and employing some 650 people, NLR achieved a turnover of 71 million euros in 2016, of which three-quarters derived from contract research, and the remaining from government funds.

For more information visit: www.nlr.nl



Transient modelling of pumped two-phase cooling systems:

Comparison between experiment and simulation with R134a

Problem area

Two-phase pumped cooling systems are applied when it is required to maintain a very stable temperature in a system, for example in the AMS02, which was launched with a space shuttle (in May 2011) and subsequently mounted on the International Space Station. However, a two-phase pumped cooling system can show complex transient behavior in response to heat load variations. For example, when the heat load is increased, a large volume of vapor is suddenly created, which results in a liquid flow into the accumulator and an increase in the pressure drop. This will result in variations in the temperature in the system, which are undesired. It is necessary to calculate these temperature variations before an application is being built. For this reason, a software tool for transient two-phase systems has been developed by NLR. This tool numerically solves the one-dimensional time-dependent compressible Navier-Stokes equations, and includes the thermal inertia of all the components. In this paper, the numerical results from the model are compared to experimental results obtained with the NLR two-phase test facility with R134a as refrigerant.

Results and conclusions

A tool has been developed that numerically solves the one-dimensional time-dependent compressible Navier-Stokes equations, and includes the thermal masses of all the components. The tool has been used for different projects, and the numerical results show an excellent agreement with experiments. In this paper, several pumped two-phase cooling systems are discussed, and a comparison between simulations and experiments is presented.

Applicability

The software tool can be used for all pumped thermal control systems.

REPORT NUMBER
NLR-TP-2017-251

AUTHOR(S)
H.J. van Gerner
R. Bolder
J. van Es

REPORT CLASSIFICATION
UNCLASSIFIED

DATE
June 2017

KNOWLEDGE AREA(S)
Space Applications

DESCRIPTOR(S)
pump
two-phase
transient
modelling
r134a

GENERAL NOTE

This report is based on paper ICES-2017-037, presented at ICES, July 16-20, 2017, Charleston, South Carolina

NLR

Anthony Fokkerweg 2

1059 CM Amsterdam

p) +31 88 511 3113 **f**) +31 88 511 3210

e) info@nlr.nl **i**) www.nlr.nl



Dedicated to innovation in aerospace

NLR-TP-2017-251 | June 2017

Transient modelling of pumped two-phase cooling systems:

Comparison between experiment and simulation with R134a

CUSTOMER: Netherlands Aerospace Centre

AUTHOR(S):

H.J. van Gerner

R. Bolder

J. van Es

NLR

Delft University

NLR

This report is based on paper ICES-2017-037, presented at ICES, July 16-20, 2017, Charleston, South Carolina

The contents of this report may be cited on condition that full credit is given to NLR and the authors.

| | |
|--------------------------------|------------------------------|
| CUSTOMER | Netherlands Aerospace Centre |
| CONTRACT NUMBER | ----- |
| OWNER | NLR |
| DIVISION NLR | Aerospace Systems |
| DISTRIBUTION | Unlimited |
| CLASSIFICATION OF TITLE | UNCLASSIFIED |

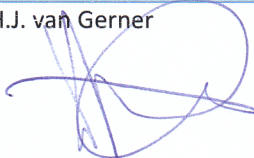
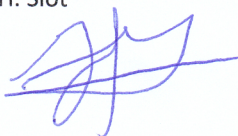
| APPROVED BY : | | |
|--------------------------------------------------------------------------------------------------------|----------------------------------------------------------------------------------------------------|-------------------------------------------------------------------------------------------------|
| AUTHOR | REVIEWER | MANAGING DEPARTMENT |
| H.J. van Gerner  | G. van Donk  | H. Slot  |
| DATE 16 06 17 | DATE 16 06 17 | DATE 21 06 17 |

Contents

| | |
|--------------------------------------------------------|-----------|
| Nomenclature | 5 |
| I. Introduction | 5 |
| II. Description of the two-phase test facility | 6 |
| III. About the numerical model | 8 |
| IV. Why is a numerical model required? | 8 |
| V. Comparison between simulation and experiment | 8 |
| A. Liquid level prediction | 10 |
| B. Saturation temperature prediction | 10 |
| C. Heater power prediction | 10 |
| D. Liquid temperature prediction | 10 |
| E. Pressure drop prediction | 10 |
| VI. Conclusion | 13 |
| References | 14 |

This page is intentionally left blank.

Transient modelling of pumped two-phase cooling systems: Comparison between experiment and simulation with R134a

Henk Jan van Gerner¹, Robin Bolder, and Johannes van Es²
National Aerospace Laboratory NLR, Amsterdam, The Netherlands

Two-phase pumped cooling systems are applied when it is required to maintain a very stable temperature in a system, for example in the AMS02, which was launched with a space shuttle (in May 2011) and subsequently mounted on the International Space Station. However, a two-phase pumped cooling system can show complex transient behavior in response to heat load variations. For example, when the heat load is increased, a large volume of vapor is suddenly created, which results in a liquid flow into the accumulator and an increase in the pressure drop. This will result in variations in the temperature in the system, which are undesired. It is necessary to calculate these temperature variations before an application is being built. For this reason, a software tool for transient two-phase systems has been developed by NLR. This tool numerically solves the one-dimensional time-dependent compressible Navier-Stokes equations, and includes the thermal inertia of all the components. In this paper, the numerical results from the model are compared to experimental results obtained with the NLR two-phase test facility with R134a as refrigerant.

Nomenclature

| | |
|-------------------|--------------------------------------------------------|
| P_{in}, P_{out} | - Power input in component, Power out of condenser (W) |
| $P_{evap\ tot}$ | - Total heat input in evaporator (W) |
| P_{accu} | - Heat input in accumulator heater (W) |
| Δp_{pump} | - Pressure drop over the pump (bar) |
| m_{pump} | - massflow through the pump (kg/s) |
| TPTF | - Two-Phase Test Facility |
| 2 Φ -MPFL | - Two-phase Mechanically Pumped Fluid Loop |

I. Introduction

Two-phase pumped cooling systems are applied when it is required to maintain a very stable temperature in a system, or when the tubing for a cooling system must have a small diameter. For example, in the AMS02, which was launched with a space shuttle (in May 2011) and subsequently mounted on the International Space Station^{1,2}. Furthermore, several two-phase thermal control systems have been built for terrestrial applications that achieve a temperature stability of 0.001°C despite a varying heat load. This paper discusses a software tool to calculate the behavior of two-phase pumped cooling systems. The software tool has previously been compared to experiments with CO₂ as refrigerant³. These simulations showed a very good agreement with the experiments. However, it is important to validate the software tool with different systems and different working fluids. For this reason, tests were carried out with the NLR Two-Phase Test Facility (TPTF) with R134a as refrigerant. These test results were compared with model results, and this comparison is discussed in this paper. The experimental measurements and part of the modelling work in this paper has been carried out by Robin Bolder as part of his MSc thesis.

¹ R&D Engineer, Space Systems, Henk.Jan.van.Gerner@nlr.nl, +31 88 511 4628.

² R&D Manager, Space Systems, Johannes.van.Es@nlr.nl, +31 88 511 4230

II. Description of the two-phase test facility

The NLR Two-Phase Test Facility (TPTF) is a two-phase Mechanically Pumped Fluid Loop (2 Φ -MPFL) that has been built in 2015/2016 and is used for component and concept testing for different customers. Figure 1 shows a schematic drawing of the TPTF and Figure 2 shows a CAD drawing. The objectives of the TPTF are:

- Develop and test new components (evaporators, pump, condenser etc.) for two-phase cooling systems
- Test novel two-phase concepts (e.g. the multiple accumulator concept)
- Verification of (transient) two-phase software tools

The TPTF is built such that components can easily be replaced and tested. This can greatly reduce the development time and costs for new component and systems.

In the TPTF, a pump is used to circulate a liquid. In the three evaporators, part of the liquid is evaporated while it absorbs the waste heat from three heat sources. The three evaporators are placed in a parallel configuration, and consist of Lytron CP 30 heat exchangers with a Minco foil heater at the top of each heat exchanger. The liquid/vapour mixture then flows to a preheat heat exchanger, in which heat from the vapor/liquid is used to warm the cold liquid that comes from the pump. In the condenser, the vapour/liquid mixture condenses back into liquid. The subcooled liquid from the condenser can have a very low temperature, and this liquid is warmed close to saturation temperature by the preheat heat exchanger before it enters the evaporator. Both the preheat heat exchanger and the condenser are SWEP B8T M plate heat exchangers. The pump is a RealTechnology NACPA II pump and a Bronkhorst M5 Cori-Flow flowmeter is used to measure the massflow. R134a is used as refrigerant (although other fluids can also be used). The outer diameter of the liquid tubing is 8 mm, and the outer diameter of the two-phase tubing is 12 mm. The absolute pressure is measured at three locations with GE UNIK 5000 pressure sensors, while the pressure difference over the pump is measured with a Validyne DP15 differential pressure sensor. The temperatures are measured at 24 locations with thermocouples.

The saturation pressure (and thereby the saturation temperature) in the system is controlled by the accumulator. The saturation pressure/temperature in the accumulator can be increased by heaters that are submerged in liquid. When these heaters are activated, vapour is created which increases the saturation pressure in the vessel. The pressure in an accumulator can be decreased by a cooling device that condenses vapour into liquid. In the TPTF, there are two accumulators in a parallel configuration. One of the accumulators can be cooled by 4 Peltier units that are sandwiched between the accumulator and 4 small heat exchangers. Two cartridge heaters are used to heat the accumulator. Figure 3 shows a CAD drawing of this accumulator. The Peltier coolers provide approximately 100 W cooling power to the accumulator. The cartridge heaters are software limited to 200W. A level sensor (Sick LFP0300 Inox) is used to measure the liquid level inside the vessel. The second accumulator is used to increase the liquid storage volume of the system. The advantage of the multiple accumulator concept is that it is very modular: Only one accumulator needs to be controlled, and the liquid storage volume can easily be increased by adding the desired number of vessels. It should be remarked that the multiple accumulator concept only works for terrestrial applications and not in space, since it relies on gravity to maintain the same liquid level in all vessels. Figure 4 and Figure 5 show photos of the facility with and without insulation. The facility with insulation was used for the experiments described in this paper.

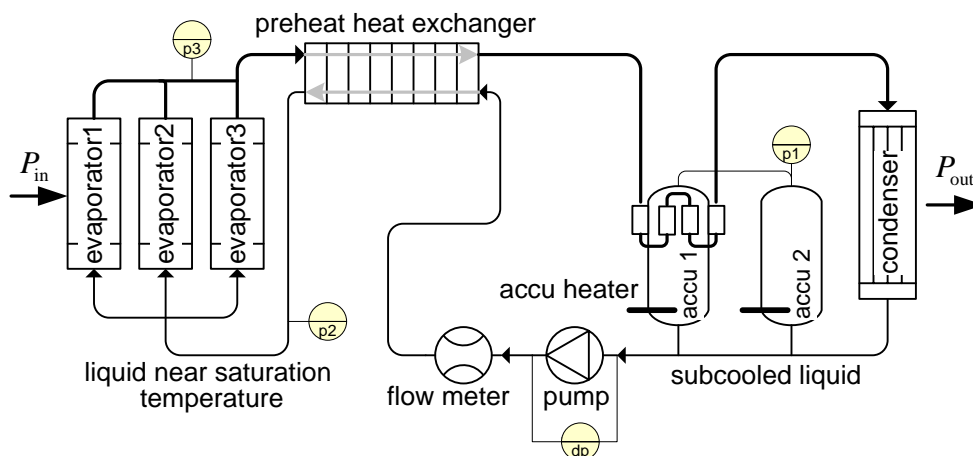

Figure 1 Schematic drawing of the Two-Phase Test Facility

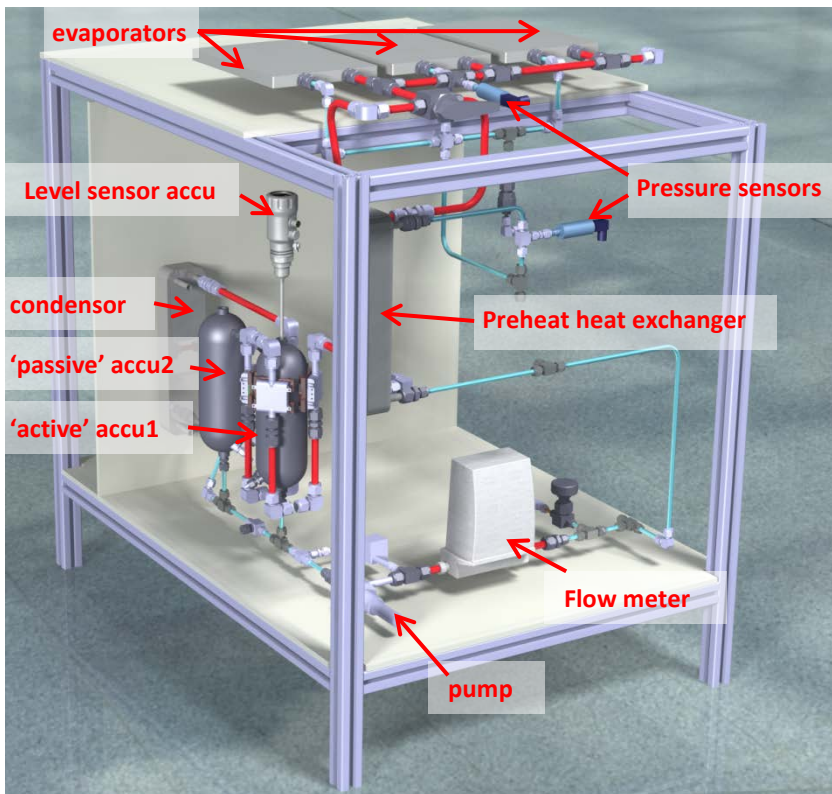

Figure 2 CAD drawing of the Two-Phase Test Facility

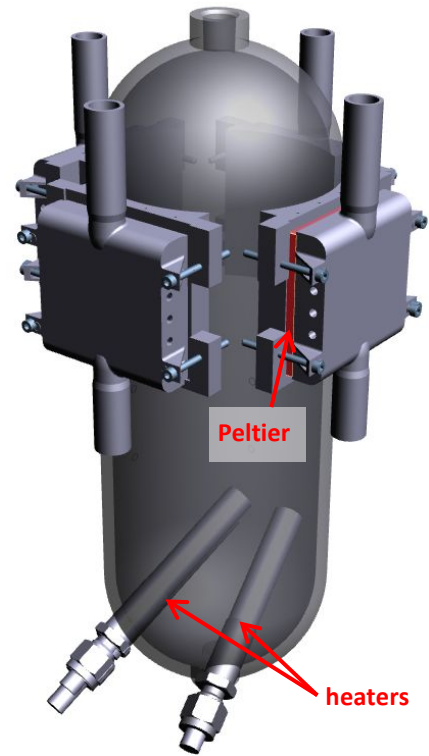

Figure 3 CAD drawing of the accumulator with heaters and Peltier coolers

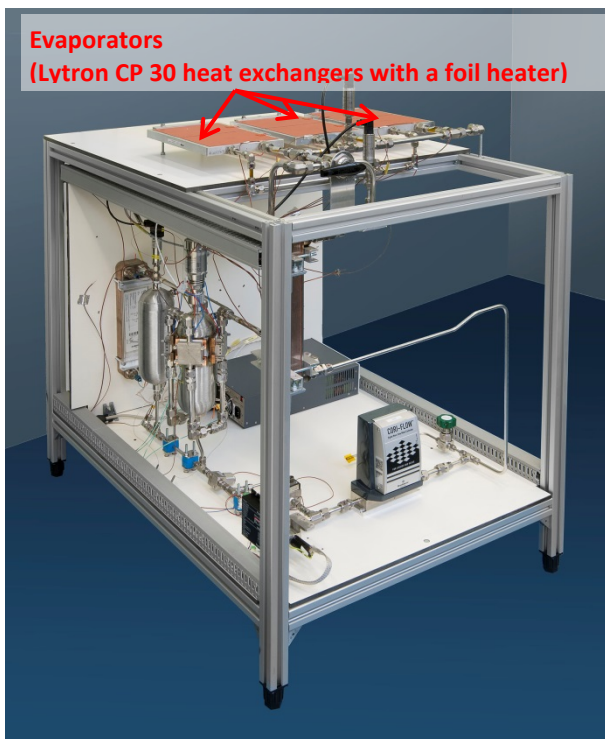

Figure 4 Photo of the Test Facility without insulation



Figure 5 Photo of the Test Facility with insulation

III. About the numerical model

The NLR has developed software to calculate the transient behavior of two-phase and single-phase pumped systems. This software numerically solves (in Matlab) the time-dependent mass and enthalpy equations for a two-phase fluid. The homogenous flow assumption is made in the model, which means that the liquid and vapour phase in a tube locally have the same velocity and temperature. The model also includes the thermal inertia of all the solid components. The frictional pressure drop in the system is calculated with the Darcy–Weisbach equation in which the friction factor for turbulent flow is calculated with the Colebrook equation⁴, and the friction factor for laminar flow is calculated with $Re/64$. For two-phase flow, the pressure drop is calculated with the Friedel correlation⁵. The Heat transfer coefficient is calculated with the Gnielinski correlation⁴ for turbulent liquid flow, with the Gungor–Winterton correlation⁶ for evaporating flow, and with the Shah correlation⁷ for condensing flow. For plate heat exchangers, the heat transfer coefficients that are provided in the manufacturer (SWEP) datasheet are used. A more detailed description of the software can be found in reference³.

The software tool has been used for a wide variety of systems, including systems with a phase separator and systems with multiple condensers and heat sinks (e.g. Two North/South radiators and two East/West radiators for a satellite application). Furthermore, the software tool has been used with many different refrigerants (R152a, ammonia, CO₂, propane, R245fa, etc.) but only the comparison between model results and experiments with CO₂ have previously been reported³. These simulations showed a very good agreement with the experiments. However, it is important to validate the software tool with different systems and different working fluids in order to check whether the assumptions that are made (e.g. the homogenous flow assumption) are valid. For this reason, tests were carried out with the NLR Two-Phase Test Facility (TPTF) with R134a as refrigerant. The two accumulators in the TPTF are treated as a single large accumulator in the model. The numerical model contains no ‘fit parameters’ that are used to match the experiments with the simulations.

IV. Why is a numerical model required?

A two-phase Mechanically Pumped Fluid Loop (2 Φ -MPFL) is usually applied when a uniform system temperature is required. This can be achieved easily with a steady-state heat load. However, when the heat load on the evaporator of a 2 Φ -MPFL changes, liquid will flow into or out of the accumulator. As a result, the pressure in the accumulator will change, and therefore the system saturation temperature. The accumulator can respond by heating/cooling inside the accumulator in order to return to the desired temperature. In principle, the accumulator can maintain exactly the desired temperature in the system when the accumulator cooling capacity is very large or when the accumulator is very big. In practice however, the cooling capacity and accumulator size are limited and the system temperature will vary. An accurate model of the complete system is required to calculate how much the temperature will vary.

V. Comparison between simulation and experiment

In both the experiments and the simulation, a R134a mass flow of 15 g/s is used. The heat load is varied between 100 and 500 W per evaporator (so 300 and 1500W in total). The cooling capacity of the Peltier units attached to the accumulator is set to 100W. The heating power for the accumulator is controlled with a PID regulator that tries to minimize the difference between the set-point saturation temperature and the actual saturation temperature. The saturation temperature is derived from one of the three pressure sensors. In the simulations and experiments discussed in this paper, the pressure sensor after the evaporators (see p3 in Figure 1) is used to control the accumulator. The same PID parameters are used for both the simulation and experiment.

Figure 6 shows the calculated steady-state temperature and vapor mass fraction with a heat input in the evaporators of 300W. The vapor mass fraction resulting from the heat input is 0.12. The heat sink temperature is 15°C. The saturation temperature is controlled by the accumulator to be 33°C. The Peltiers deliver a 100W cooling capacity in the accumulator, so in steady state, the accumulator heaters need to supply 100W of heating power to maintain a constant temperature in the accumulator.

Figure 7 shows the calculated steady-state temperature and vapor mass fraction with a heat input in the evaporators of 1500W. In the evaporator, the vapor mass fraction is increased to 0.6 due to the increased heat input. This higher vapour mass fraction results in a higher liquid level in the accumulator.

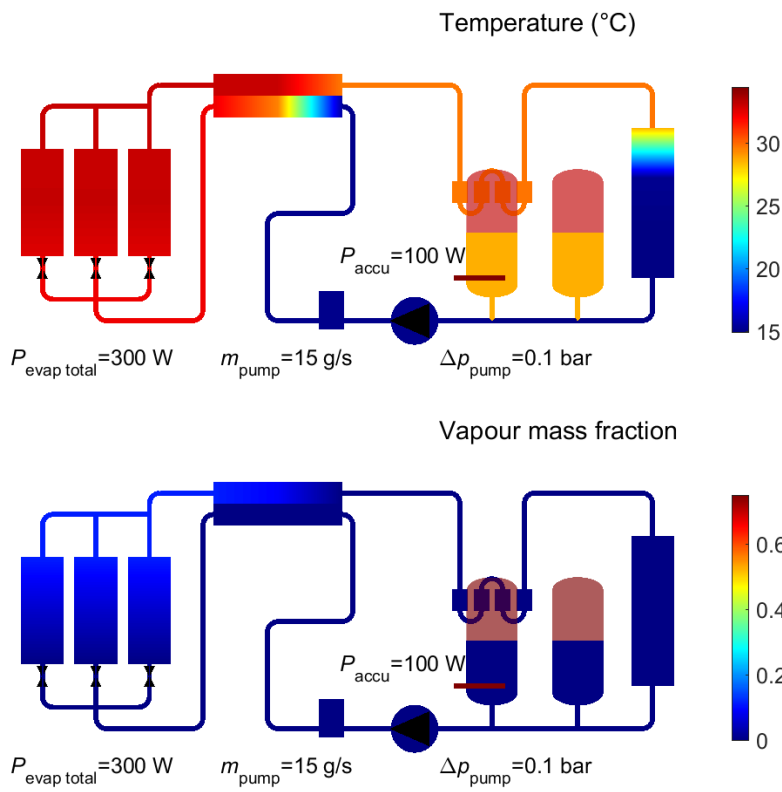

Figure 6 Temperature and vapor mass fraction for $P=300 \text{ W}$

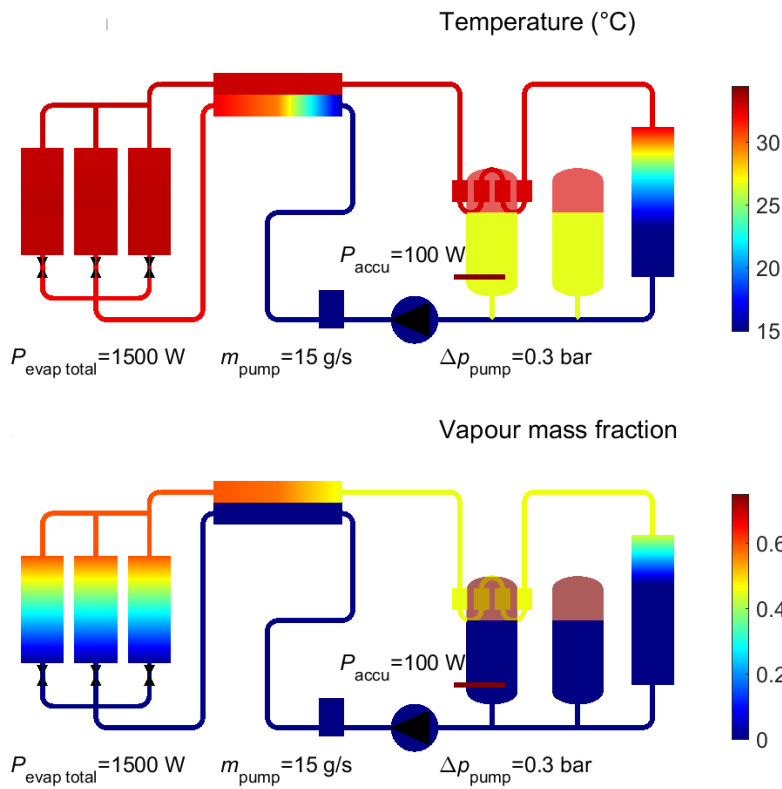

Figure 7 Temperature and vapor mass fraction for $P=1500 \text{ W}$

Figure 8 shows the evaporator heat input for both the experiments and simulations. In the left figure, the heat input is increased from 300 to 1500 W, and in the right figure, the heat input is decreased from 1500 to 300W. The result of these heat input variations is discussed in the next sections.

A. Liquid level prediction

As a result of an increase in the evaporator heat input, liquid will flow into the accumulator (see Figure 9). When the heat input is decreased, liquid flows out of the accumulator. Both in the experiment as in the simulation, the liquid level oscillates after the reduction in heat input, although the oscillation is damped out more quickly in the experiment than in the simulation.

B. Saturation temperature prediction

Figure 10 shows the saturation temperature at the exit of the evaporators. The PID controller for the accumulator heater tries to keep this saturation temperature at 33°C. However, as a result of the liquid inflow into the accumulator, the saturation temperature in the system will increase. The correspondence between the experiment and simulation is good (within 1°C), although the simulation somewhat underestimates the variations in the temperature when the heat load is increased.

C. Heater power prediction

Figure 11 shows the power of the heater in the accumulator. This heater is PID controlled; when the saturation temperature in the system is lower than 33°C, the power will be increased, and when the saturation temperature is higher than 33°C, the power will be decreased. In steady-state, the heater power is equal to the cooling power of the Peltier units on the accumulator. When fluid flows into the accumulator, the accumulator heater power is quickly reduced to zero, making the accumulator remove heat from the system. The figure shows that initially after an evaporator power change, the simulated and experimental accumulator heater power is very similar. However, the experimental heating power shows more ‘overshoot’ than the simulation. The reason for this is not well understood, since the PID parameters are the same for both the experiment and simulation. A possible reason could be that the PID controller in the experiment responds differently when the limits of the heater power are reached (i.e. $P_{\text{heat accu}} = 0$ or $P_{\text{heat accu}} = 200\text{W}$).

D. Liquid temperature prediction

Figure 12 shows the temperature of the liquid before and after the preheat heat exchanger. The preheat heat exchanger increases the liquid temperature from 15°C to almost 33°C before it enters the evaporator. This passive heat exchanger therefore ensures that the payload section remains at a constant temperature. At $t=5$ minutes and $t=8$ minutes after the heat input is decreased, warm liquid flows out of the accumulator (see Figure 9) and mixes with the cold liquid that comes from the condenser. As a result, the temperature of the liquid that goes to the pump and heat exchanger is temporarily increased. In order to prevent pump cavitation, it is required that the liquid that enters the pump is subcooled (i.e. that the temperature is a few degrees lower than the saturation temperature). When there is only a small amount of subcooling for the pump, the flow of warm liquid out of the accumulator can result in pump cavitation, and simulations like this can help to predict under which circumstances pump cavitation could occur.

E. Pressure drop prediction

Figure 13 shows the pressure drop over the pump. With a heat load of 300W, the pressure drop over the pump is 0.2 bar while with a heat load of 1500W, the pressure drop is 0.3 bar. This increase in the pressure drop results from the much higher volume flow when the vapour mass fraction is higher.

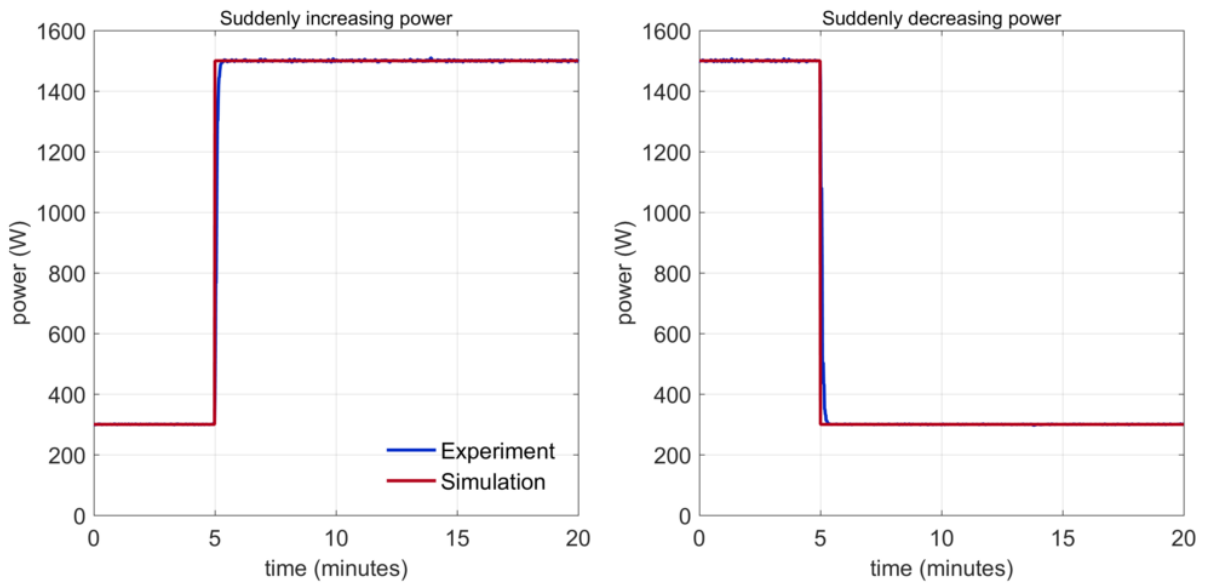

Figure 8 Evaporator heat input for both the experiment and simulation

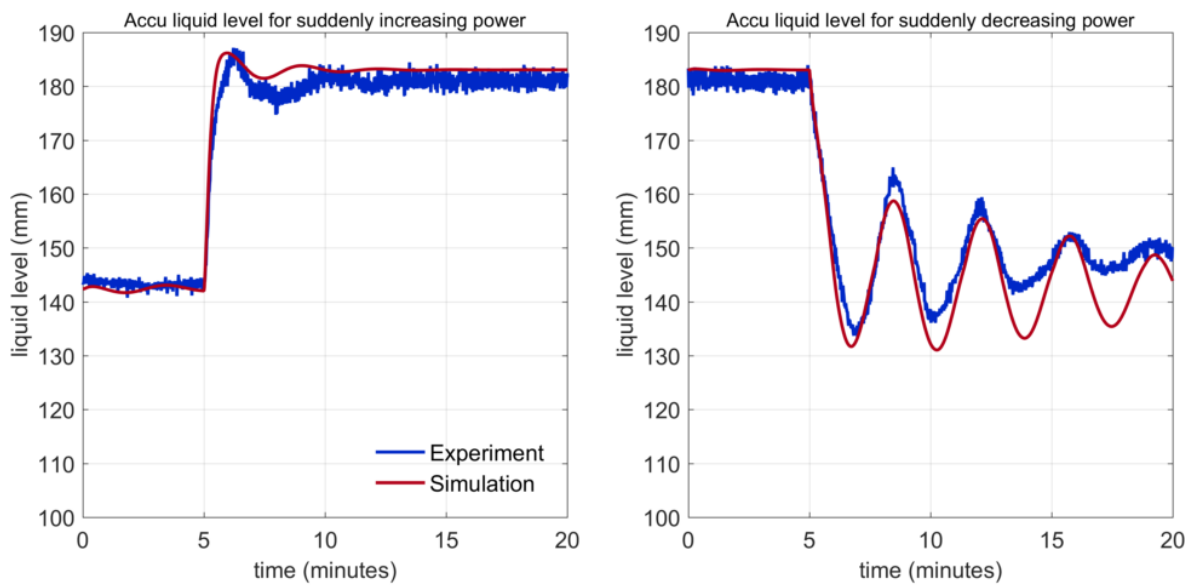

Figure 9 Liquid level variation in the accumulator as a result of an increase and decrease of the heat input

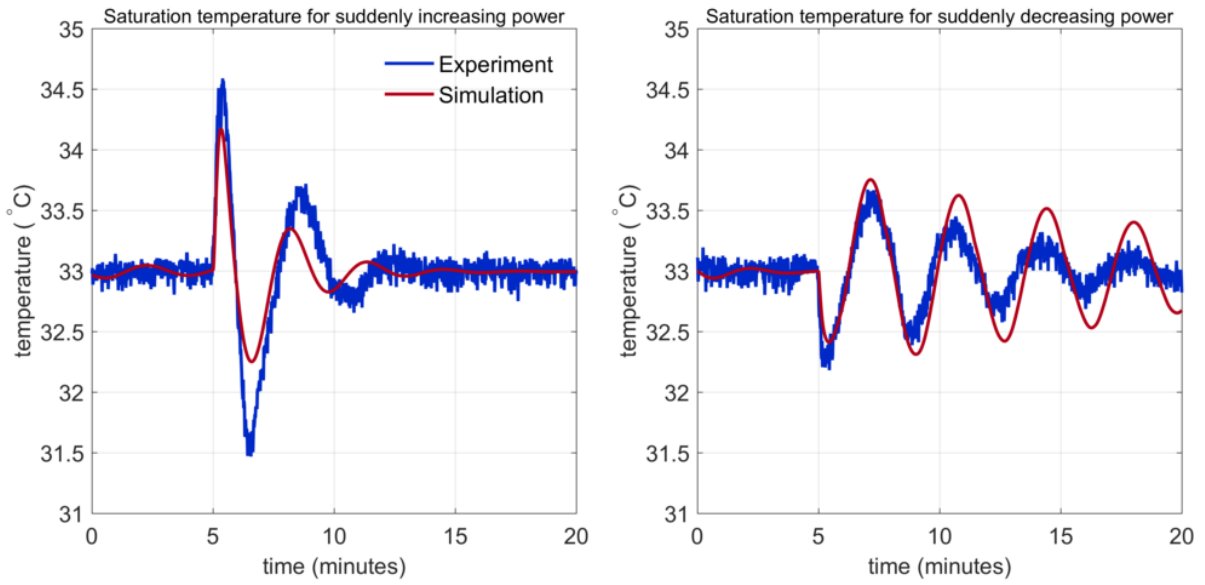

Figure 10 Saturation temperature after the evaporator

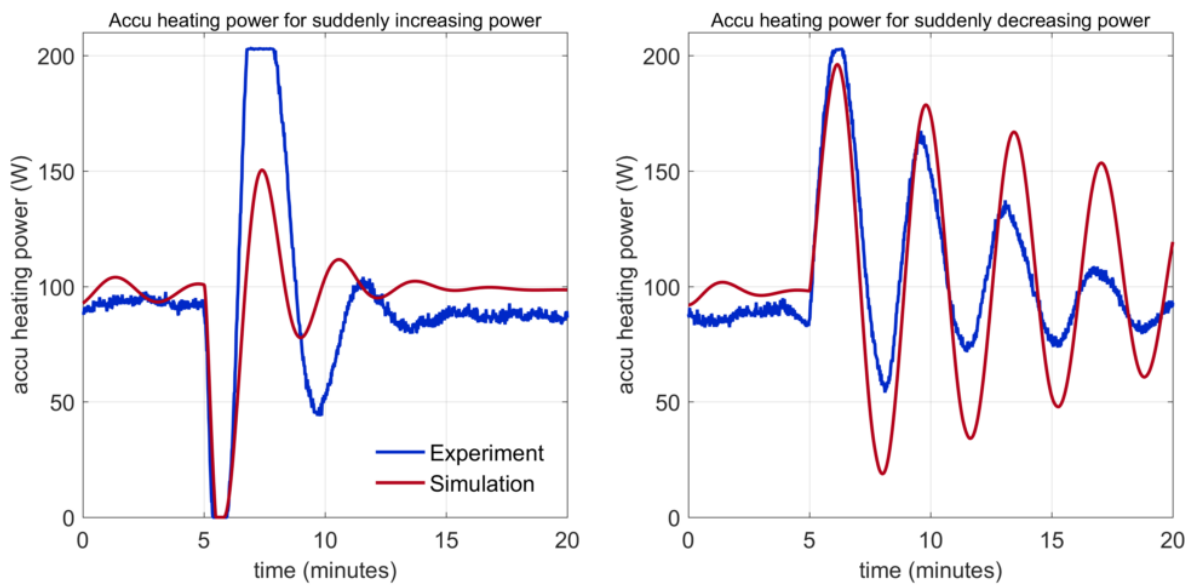

Figure 11 Heating power in the accumulator. This heating power is regulated with a PID controller

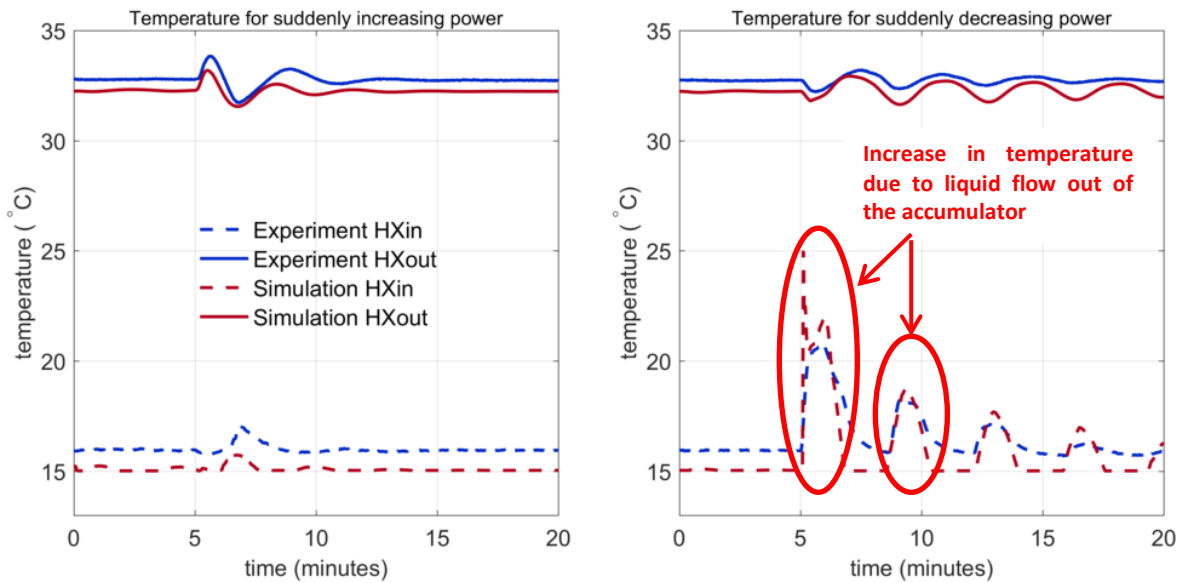

Figure 12 Liquid temperature before and after the preheat heat exchanger

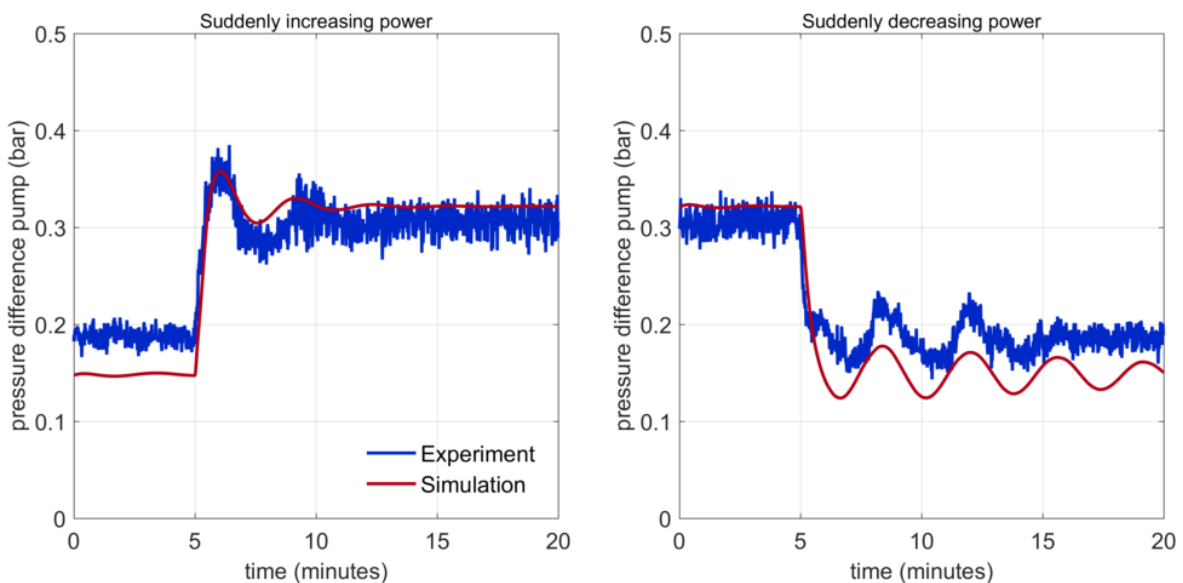

Figure 13 Pressure drop over the pump

VI. Conclusion

When the heat load on a two-phase pumped system changes, liquid will flow into or out of the accumulator. As a result, the pressure in the accumulator will change, and therefore the system saturation temperature. An accurate model of the complete system is required to calculate how much the temperature will vary. For this reason, a software tool that numerically solves the time-dependent mass and enthalpy equation for a two-phase fluid has been developed. The model also includes the thermal inertia of all the solid components. This paper shows that the numerical tool is able to accurately predict the behavior of a two-phase pumped system; The correspondence between the transient saturation temperature in the experiment and simulation is within 1°C, and the model is able to simulate transient phenomena, such as the temporarily increase in the temperature of the liquid that flows to the pump when the evaporator power is suddenly decreased. As a result, the model can be used to design two-phase pumped cooling systems and to predict the behavior before a system has been built. This reduces the development time and costs of two-phase pumped cooling systems. There is however some room for improvement. For example,

the accumulator heater power has more ‘overshoot’ in the experiment than in the simulation, and the reason for this is not well understood.

References

- ¹AMS-02, The Alpha Magnetic Spectrometer experiment, URL: <http://www.ams02.org/> [cited 20 January 2014]
- ²van Es, J., Pauw A., van Donk G., Laudi E., Gargiulo C., He Z., Verlaat B., Ragnit U., van Leeuwen P., “AMS02 Tracker Thermal Control Cooling System: Test Results of the AMS02 Thermal Vacuum Test in the LSS at ESA ESTEC”, AIAA 2012-3577 (2012)
- ³van Gerner, H. J., Braaksma, N., “Transient modelling of pumped two-phase cooling systems: Comparison between experiment and simulation”, 46th International Conference on Environmental Systems, ICES-2016-004
- ⁴Incropera, F.P., Dewitt, D.P., Bergman, T.L., Lavine, A.S., “Fundamentals of heat and mass transfer”, (John Wiley & Sons, Hoboken, 2007)
- ⁵Friedel, L., “Improved friction pressure drop correlation for horizontal and vertical two phase pipe flow”, European Two Phase Flow Group Meeting, Paper 18 (Ispra, Italy, 1979) p. 485–492.
- ⁶Gungor, K., Winterton, R., “Simplified general correlation for saturated flow boiling and comparisons of correlations with data”, The Canadian Journal of Chemical Engineering 65, 148 (1987)
- ⁷Shah, M.M., “An Improved And Extended general Correlation for Heat Transfer During Condensation in Plain Tubes”, HVAC&R Research, vol. 15, no. 5, pp. 889-913, 2009.

NLR

Anthony Fokkerweg 2

1059 CM Amsterdam, The Netherlands

p) +31 88 511 3113 f) +31 88 511 3210

e) info@nlr.nl i) www.nlr.nl