



Dedicated to innovation in aerospace

NLR-TP-2017-149 | May 2017

# Practices to identify and prevent adverse aircraft-and-rotorcraft-pilot couplings - A ground simulator perspective

CUSTOMER: European Commission



NLR – Netherlands Aerospace Centre

## Netherlands Aerospace Centre

NLR is a leading international research centre for aerospace. Bolstered by its multidisciplinary expertise and unrivalled research facilities, NLR provides innovative and integral solutions for the complex challenges in the aerospace sector.

NLR's activities span the full spectrum of Research Development Test & Evaluation (RDT & E). Given NLR's specialist knowledge and facilities, companies turn to NLR for validation, verification, qualification, simulation and evaluation. NLR thereby bridges the gap between research and practical applications, while working for both government and industry at home and abroad.

NLR stands for practical and innovative solutions, technical expertise and a long-term design vision. This allows NLR's cutting edge technology to find its way into successful aerospace programs of OEMs, including Airbus, Embraer and Pilatus. NLR contributes to (military) programs, such as ESA's IXV re-entry vehicle, the F-35, the Apache helicopter, and European programs, including SESAR and Clean Sky 2.

Founded in 1919, and employing some 650 people, NLR achieved a turnover of 71 million euros in 2016, of which three-quarters derived from contract research, and the remaining from government funds.

For more information visit: [www.nlr.nl](http://www.nlr.nl)

# Practices to identify and prevent adverse aircraft-and-rotorcraft-pilot couplings - A ground simulator perspective



## Problem area

The aviation community relies heavily on flight simulators as a fundamental tool for research, pilot training and new aircraft design. In the broadest sense, a flight simulator may be defined as a device capable of synthetically replicating the behaviour of the simulated aircraft to as high a standard or fidelity as its component parts will allow. Typically, flight simulators are used during the development of an aircraft to conduct basic aeronautical vehicle or systems research or as a means to train pilots and crew. One field of aviation research using ground-based simulators that is particularly sensitive to the representativeness of the simulation component parts is the ability to reveal the existence of adverse aircraft/rotorcraft pilot couplings (A/RPCs) in an aircraft. It is unlikely, however, that a flight simulator will ever be able to satisfactorily recreate all of the different elements of an actual flight to the highest fidelity. The specialist literature in this field reveals contradictory evidence for the effectiveness of ground-based simulation facilities as an A/RPC assessment tool. The general view is that ground based simulators are not reliable enough in revealing the existence of adverse A/RPC tendencies.

## Description of work

The ARISTOTEL project 'Aircraft and Rotorcraft Pilot Couplings – Tools and Techniques for Alleviation and Detection' (2010-2013) in Europe performed a series of simulator test campaigns to understand and advance the state-of-the-art

### REPORT NUMBER

NLR-TP-2017-149

### AUTHOR(S)

M.H. Smaili  
M.D. Pavel  
M. Jump  
P. Masarati  
L. Zaichik  
B. Dang-Vu  
G. Quaranta  
O. Stroosma  
D. Yilmaz  
M. Johnes  
M. Gennaretti  
A. Ionita

### REPORT CLASSIFICATION

UNCLASSIFIED

### DATE

May 2017

### KNOWLEDGE AREA(S)

Cockpit  
Aeroelasticity and Loads  
Training, Mission  
Simulation and Operator  
Performance

### DESCRIPTOR(S)

structural elasticity  
handling qualities  
flight control systems  
pilot manipulator  
aircraft-pilot coupling

in the prediction of A/RPC phenomena using flight simulators (in relation to both biodynamic and active pilot in the loop testing). The goal of the present paper is to review the findings of the ARISTOTEL project, specifically in relation to ground based simulator testing to unmask A/RPCs.

## Results and conclusions

The ARISTOTEL project demonstrated that ground-based simulation can be effectively used as an assessment tool for unwanted aircraft/rotorcraft pilot couplings phenomena. The project demonstrated that a proper selection of high gain tasks, combined with appropriate motion and visual cueing, can reveal negative features of a particular aircraft or rotorcraft that may lead to A/RPC. In order to unmask such complex instabilities, the simulator constituent parts (motion system, visuals, mathematical model, and control loading system) must be carefully adapted. A difference in the susceptibility of each pilot, based on their strategy, was observed in the project.

## Applicability

Although flight simulators will likely never achieve the level of reality of in-flight testing, exposing A/RPC tendencies in the simulator may be the only safe place to evaluate the wide range of conditions that could produce hazardous A/RPC events. The results of the ARISTOTEL project provide simulator practises, aimed at aircraft and rotorcraft manufactures, needed for unmasking adverse A/RPCs.

### GENERAL NOTE

This report is based on a paper published in *Progress in Aerospace Sciences*, August 2015, by Elsevier.

### NLR

Anthony Fokkerweg 2  
1059 CM Amsterdam

p ) +31 88 511 3113 f ) +31 88 511 3210

e ) info@nlr.nl i ) www.nlr.nl



# Practises to identify and prevent adverse aircraft-and-rotorcraft-pilot couplings - A ground simulator perspective

**CUSTOMER:** European Commission

**AUTHOR(S):**

<b>M.H. Smaili</b>	NLR
<b>M.D. Pavel</b>	TU Delft
<b>M. Jump</b>	University of Liverpool
<b>P. Masarati</b>	University of Milan
<b>L. Zaichik</b>	TsAGI
<b>B. Dang-Vu</b>	ONERA
<b>G. Quaranta</b>	University of Milan
<b>O. Stroosma</b>	TU Delft
<b>D. Yilmaz</b>	TU Delft
<b>M. Johnes</b>	TsAGI
<b>M. Gennaretti</b>	University of Rome
<b>A. Ionita</b>	STRAERO

This report is based on a paper published in Progress in Aerospace Sciences, August 2015, by Elsevier.

*The contents of this report may be cited on condition that full credit is given to NLR and the author(s).*

<b>CUSTOMER</b>	European Commission
<b>CONTRACT NUMBER</b>	266073
<b>OWNER</b>	NLR + partner(s)
<b>DIVISION NLR</b>	Aerospace Operations
<b>DISTRIBUTION</b>	Unlimited
<b>CLASSIFICATION OF TITLE</b>	UNCLASSIFIED

APPROVED BY :																			
AUTHOR				REVIEWER				MANAGING DEPARTMENT											
M.H. Smali				External reviewers															
DATE	1	6	0	5	1	7	DATE						DATE	2	3	0	5	1	7

# Contents

<b>Abstract</b>	<b>5</b>
<b>Abbreviations</b>	<b>5</b>
<b>1 Introduction</b>	<b>6</b>
1.1 Flight simulators: ideal devices for training and research	6
1.2 Flight simulator fidelity	7
1.3 Aircraft/rotorcraft pilot couplings	8
1.4 Can ground-based simulators reveal the existence of adverse A/RPC?	9
<b>2 Simulator characteristics relevant to the A/RPC problem</b>	<b>10</b>
<b>3 Simulator motion system characteristics</b>	<b>12</b>
3.1 Quantitative motion cueing criteria	13
3.2 Rigid body RPC motion tuning	14
3.3 Aeroelastic APC motion tuning	18
<b>4 Simulator visual system characteristics</b>	<b>18</b>
<b>5 Simulator control loading characteristics</b>	<b>20</b>
5.1 Control loading analysis in fixed wing aircraft	20
<b>6 Simulator mathematical model characteristics</b>	<b>23</b>
<b>7 Selection of flight tasks exposing A/RPC tendencies in the simulator</b>	<b>24</b>
7.1 Selection of flight tasks for exposing APC in the simulator	24
7.2 The Adverse Pilot Coupling Rating (APC) scale	25
7.3 Selection of flight tasks for exposing RPC in the simulator	28
7.4 Phase Aggression Criterion (PAC) as a measure of A/RPC tendencies in simulator testing	29
<b>8 Simulator latency characteristics</b>	<b>31</b>
<b>9 Conclusions</b>	<b>32</b>
<b>Acknowledgements</b>	<b>33</b>
Appendix A.1 Motion Fidelity rating scale	33
Appendix A.2 Visual Cue Rating	34
Appendix A.3 Simulation Fidelity Rating scale (SFR)	34
Appendix A.4 Traditional PIO Rating scale (PIOR)	35
Appendix A.5 Adverse Pilot Coupling APC rating scale (APC)	36
<b>References</b>	<b>36</b>

*This page is intentionally left blank.*



Contents lists available at ScienceDirect

## Progress in Aerospace Sciences

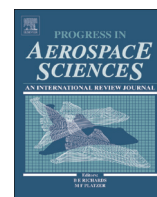
journal homepage: [www.elsevier.com/locate/paerosci](http://www.elsevier.com/locate/paerosci)

## Practises to identify and prevent adverse aircraft-and-rotorcraft-pilot couplings—A ground simulator perspective <sup>☆</sup>

Marilena D. Pavel <sup>a,\*</sup>, Michael Jump <sup>b</sup>, Pierangelo Masarati <sup>c</sup>, Larisa Zaichik <sup>d</sup>,  
 Binh Dang-Vu <sup>e</sup>, Hafid Smali <sup>f</sup>, Giuseppe Quaranta <sup>c</sup>, Olaf Stroosma <sup>a</sup>, Deniz Yilmaz <sup>a</sup>,  
 Michael Johnes <sup>d</sup>, Massimmo Gennaretti <sup>g</sup>, Achim Ionita <sup>h</sup>

<sup>a</sup> Delft University of Technology, Kluyverweg 1, 2629HS Delft, The Netherlands

<sup>b</sup> University of Liverpool, Brownlow Hill, L69 3GH Liverpool, England

<sup>c</sup> Politecnico di Milano, Via La Masa 34, I-20156 Milano, Italy

<sup>d</sup> TsAGI, Zhukovskiy Str., 140180 Zhukovskiy, Russian Federation

<sup>e</sup> ONERA, Base Aérienne 701, FR-13661 Salon de Provence, France

<sup>f</sup> NLR, Anthony Fokkerweg 2, NL-1059 CM Amsterdam, The Netherlands

<sup>g</sup> Università Roma Tre, Via della Vasca Navale 79, I-00146 Roma, Italy

<sup>h</sup> STRAERO, B-dul Iuliu Maniu 220, Bucharest, Romania

## ARTICLE INFO

## Article history:

Received 27 November 2014

Received in revised form

23 June 2015

Accepted 25 June 2015

## Keywords:

Aircraft Pilot Couplings  
(APC)

Rotorcraft Pilot Couplings (RPC)

Pilot Induced Oscillations (PIO)

Pilot Assisted Oscillations (PAO)

Simulator Fidelity

Motion Cues

Visual Cues

Control Loading

Time delay

Latency

Biodynamic Feedthrough

## ABSTRACT

The aviation community relies heavily on flight simulators as a fundamental tool for research, pilot training and development of any new aircraft design. The goal of the present paper is to provide a review on how effective ground simulation is as an assessment tool for unmasking adverse Aircraft-and-Rotorcraft Pilot Couplings (APC/RPC). Although it is generally believed that simulators are not reliable in revealing the existence of A/RPC tendencies, the paper demonstrates that a proper selection of high-gain tasks combined with appropriate motion and visual cueing can reveal negative features of a particular aircraft that may lead to A/RPC. The paper discusses new methods for real-time A/RPC detection that can be used as a tool for unmasking adverse A/RPC. Although flight simulators will not achieve the level of reality of in-flight testing, exposing A/RPC tendencies in the simulator may be the only convenient safe place to evaluate the wide range of conditions that could produce hazardous A/RPC events.

© 2015 Elsevier Ltd. All rights reserved.

## Contents

1. Introduction.....	2
----------------------	---

*Abbreviations:* AD, Acceleration Deceleration Manoeuvre; A/RPCs, Aircraft-and-Rotorcraft-Pilot Couplings; APC, Adverse Pilot Couplings Rating Scale; ARISTOTEL, Aircraft and Rotorcraft Pilot Couplings – Tools and Techniques for Alleviation and Detection; BAT, Boundary Avoidance Tracking; BDFT, Biodynamic Feedthrough; DC, Duty Cycle Criterion; DOF, Degree of Freedom; FBW, Fly-by-Wire; FCS, Flight Control System; FoV, Field of View; GRACE, Generic Research Aircraft Cockpit Environment simulator at NLR; HQs, Handling Qualities; HQR, Handling Qualities Rating; HFR, HELIFLIGHT-R Simulator at University of Liverpool; MCR, Motion Cue Rating Scale; MTE, Mission Task Element; PAC, Phase Aggression Criterion; PH, Precision Hover; PIO/PAO, Pilot Induced Oscillations/ Pilot Assisted Oscillations; PIOR, PIO Rating; PR, Pilot Rating; ΔPR, Pilot rating worsening; PVS, Pilot-Vehicle System; ROVER, Real-time Oscillation Verifier; RS, Roll Step Manoeuvre; SFR, Simulator Fidelity Rating Scale; SRS, Simona Research Simulator at TU Delft; UCE, Usable Cue Environment; VCR, Visual Cue Rating; VM, Vertical Manoeuvre; VMS, Vertical Motion Simulator at NASA Ames; ZFTT, Zero Flight Time Training

<sup>☆</sup>‘Fitting the simulator to the task is key to getting meaningful results.’ (Col. Richard Borowski, Wright-Patterson Air Force Base)

\* Corresponding author. Tel.: +31 15 2785374.

E-mail address: [m.d.pavel@tudelft.nl](mailto:m.d.pavel@tudelft.nl) (M.D. Pavel).

<http://dx.doi.org/10.1016/j.paerosci.2015.06.007>

0376-0421/© 2015 Elsevier Ltd. All rights reserved.

1.1.	Flight simulators: ideal devices for training and research.....	2
1.2.	Flight simulator fidelity.....	3
1.3.	Aircraft/rotorcraft pilot couplings.....	4
1.4.	Can ground-based simulators reveal the existence of adverse A/RPC?.....	5
2.	Simulator characteristics relevant to the A/RPC problem.....	6
3.	Simulator motion system characteristics.....	8
3.1.	Quantitative motion cueing criteria.....	9
3.2.	Rigid body RPC motion tuning.....	10
3.3.	Aeroelastic APC motion tuning.....	14
4.	Simulator visual system characteristics.....	14
5.	Simulator control loading characteristics.....	16
5.1.	Control loading analysis in fixed wing aircraft.....	16
6.	Simulator mathematical model characteristics.....	19
7.	Selection of flight tasks exposing A/RPC tendencies in the simulator.....	20
7.1.	Selection of flight tasks for exposing APC in the simulator.....	20
7.2.	The Adverse Pilot Couplings Rating (APC) scale.....	21
7.3.	Selection of flight tasks for exposing RPC in the simulator.....	24
7.4.	Phase Aggression Criterion (PAC) as a measure of A/RPC tendencies in simulator testing.....	25
8.	Simulator latency characteristics.....	27
9.	Conclusions.....	28
	Acknowledgements.....	29
Appendix A. 1	Motion Fidelity rating scale.....	29
Appendix A. 2	Visual Cue Rating.....	30
Appendix A. 3	Simulation Fidelity Rating scale (SFR).....	30
Appendix A. 4	Traditional PIO rating scale (PIOR).....	31
Appendix A. 5	Adverse Pilot Coupling APC rating scale (APC).....	32
	References.....	32

**1. Introduction**

The aviation community relies heavily on flight simulators as a fundamental tool for research, pilot training and new aircraft design development. In the broadest sense, a flight simulator may be defined as a device capable of synthetically replicating the behaviour of the simulated aircraft to as high a standard or fidelity as its component parts will allow. Typically, flight simulators are used during the development of an aircraft, to conduct basic aeronautical vehicle or systems research or as a means to train pilots and crew. This paper provides the most up-to-date research on the former of these, specifically the use of flight simulators to unmask a phenomenon known as adverse aircraft/rotorcraft pilot coupling. However, to set this work in its wider context, a very brief review of flight simulation being used for training is also presented.

*1.1. Flight simulators: ideal devices for training and research*

The flight simulator, as would be recognised by modern engineers, was invented in 1931 by Ed Link [1] to be used as a pilot training device. However, as early as 1910, the need for simulators was recognised to familiarise the pioneer pilots with the control characteristics of aircraft of the day. The first recorded flight simulator was the “Antoinette Learning Barrel”, shown in Fig. 1. In this flight training device a pilot was required to use the controls to keep a horizontal reference bar aligned with the horizon as the barrels were moved by human operators to represent pitch, roll and yaw.

For training purposes, flight simulators can range from low-cost procedural trainers to high fidelity, high-cost simulators. From these early beginnings, pilots now conduct a significant part of both their initial and recurrent training through the use of simulated flying time. For example, Fig. 2 shows the HELISIM facility [34] specially dedicated to helicopter pilot training at Eurocopter (now Airbus Helicopters) in France with certified

Level D simulators<sup>1</sup>. The advantages of such training flight simulators are recognised and most modern flying organisations, both civil and military, use such devices. In 2006, the International Civil Aviation Organisation (ICAO) launched the Multi-crew Pilot License (MPL) which was designed to drastically reduce the number of real flight training hours required to reach the first-officer seat of a fixed wing airliner compared to the more traditional Air Transport Pilot’s License (ATPL). The bulk of the flying training for this license is conducted in state-of-the art fixed wing simulators, the intent being to reduce the cost for both the airline and the prospective license holder. In addition, so-called “zero flight time training (ZFTT)” [3] means that a pilot can gain a Type Rating on an aircraft using a training syllabus on a suitably qualified flight simulator. ZFTT may be conducted only in a flight simulator qualified in accordance with JAR-STD Level C or D simulators [3,65] and user approved for ZFTT by the Authority.

For research purposes, flight simulators can be used both, at a basic level and at an aircraft programme level. Figs. 3 and 4 show examples of research simulators used for research into flight control systems, handling qualities and cockpit interfaces [5]. Fig. 3 shows the research simulators used in the European project ARISTOTEL - Aircraft and Rotorcraft Pilot Couplings-Tools and Techniques for Alleviation and Detection- (2010-2013) [14-33]. The results from this project form the bulk of the remainder of this

<sup>1</sup> The full flight simulators (FFS) can be divided in four levels of fidelity: (1) Level A - A motion system is required with at least three degrees of freedom. Airplanes only; (2) Level B - Requires three axis motion and a higher-fidelity aerodynamic model than does Level A. The lowest level of helicopter flight simulator. (3) Level C - Requires a motion platform with all six degrees of freedom. Also lower transport delay (latency) over levels A & B. The visual system must have an outside-world horizontal field of view of at least 75 degrees for each pilot. (4) Level D - The highest level of FFS qualification currently available. Requirements are for Level C with additions. The motion platform must have all six degrees of freedom, and the visual system must have an outside-world horizontal field of view of at least 150 degrees, with a Collimated (distant focus) display. Realistic sounds in the cockpit are required, as well as a number of special motion and visual effects.



Fig. 1. The Antoinette Learning Barrel [2].

paper. Fig. 4 (left hand side) shows the Vertical Motion Simulator (VMS) at NASA Ames in USA [11], a unique facility in terms of the range of motion that it can provide to the pilot and the newer CyberMotion simulator at Max Planck Institute, Germany (<http://www.kyb.tuebingen.mpg.de>) which is a robot arm simulating sustained accelerations by rotating the robot around its base axis.

### 1.2. Flight simulator fidelity

Whilst there is theoretically no limit as to how representative the flight dynamics mathematical model of an aircraft in its operating environment can be in a flight simulator, the exact

duplication of all aircraft characteristics is unlikely to be achieved, regardless of the simulator's computing power. This is because ground-based simulation involves many other component parts, including the visual, motion and control loading systems, the control inceptors, pilot displays, and audio and vibration environments, all of which contribute to the pilot's feeling of 'immersion' in the simulation [6]. The capabilities of simulator visual and motion systems, in particular, are still limited when compared to reality. To be able to more faithfully replicate the real world that flight simulators are intended to represent, the associated technologies need to be advanced further. In this sense, there is a need to define first the term 'simulator fidelity' to be used in this paper.

Generally, there is not an agreed definition of 'fidelity' and its related terminology [7]. The classic use of the term 'fidelity' refers to the 'physical fidelity', i.e. "*the degree to which the device must duplicate the actual equipment*" [9]. In this context, dimensions such as the visual scene simulation, cockpit environment representation and motion accelerations are relevant aspects of physical fidelity [8,9,12]. The physical fidelity approach to simulators based on designing and measuring simulator physical components can also be seen in the Federal Aviation Administration (FAA) categories of flight simulators used for training [68]. However, more recently, there has been a trend to shift simulator fidelity from physical fidelity towards 'perceived fidelity' or "cognitive fidelity" [10,77,80], i.e. "*the degree to which the device can induce adequate human psychomotor and cognitive behaviour*" for a given task and environment. Conceivably, in the future, comprehensive fidelity assessment methodologies will be adopted for the assessment of simulator fidelity utilising physical fidelity, together with perceived and cognitive measures, to systematically capture pilot opinion. For the moment though, physical fidelity, as the

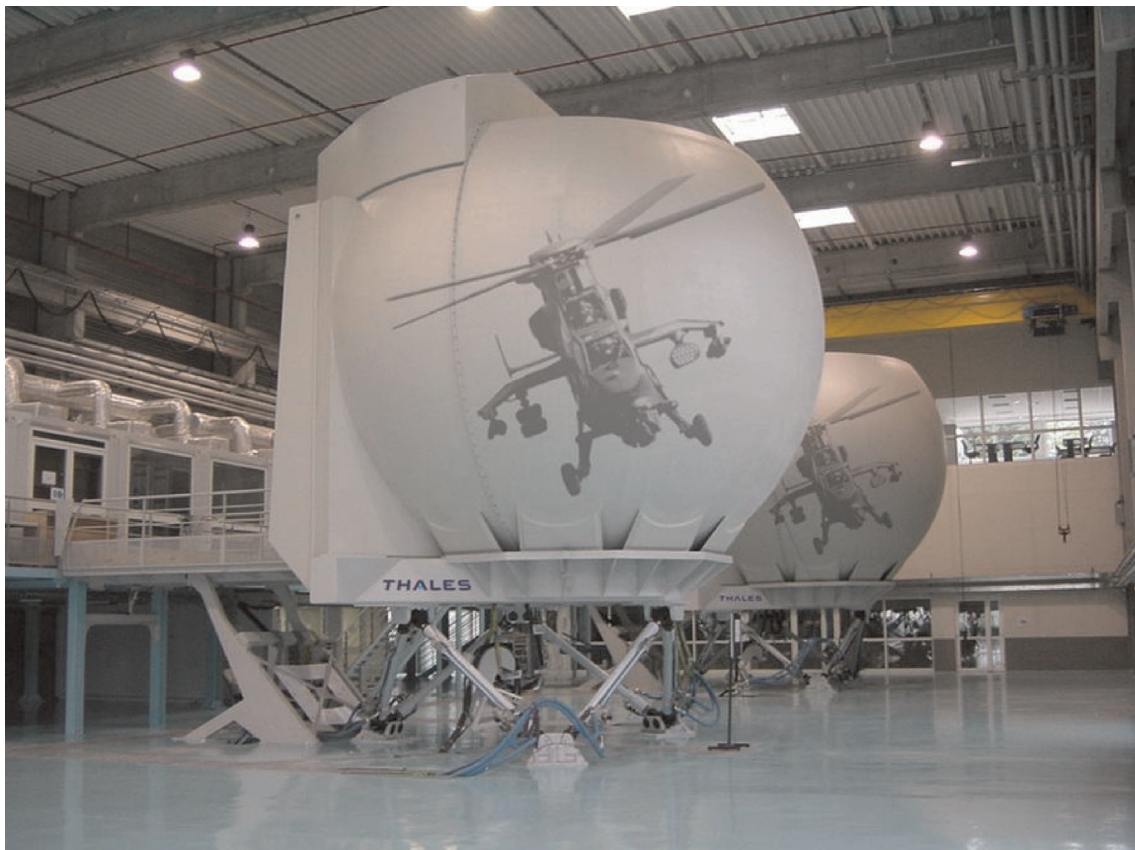

Fig. 2. Example of training simulators: the HELISIM facility at Airbus Helicopters [34].



Fig. 3. Examples of research simulators: the simulators used in ARISTOTEL project [16].

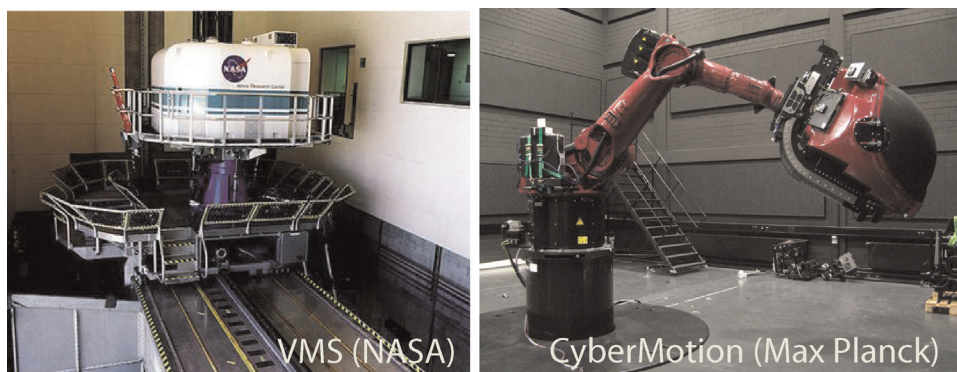

Fig. 4. Other examples of research simulators: the VMS simulator at NASA Ames in USA (<http://futureflight.arc.nasa.gov/>) and the CyberMotion at Max Planck Institute in Germany (<http://www.kyb.tuebingen.mpg.de>).

most common use of the term fidelity will be used throughout this paper.

### 1.3. Aircraft/rotorcraft pilot couplings

One field of aviation research using ground-based simulators that is particularly sensitive to the representativeness of the simulation component parts is the ability to reveal the existence of adverse aircraft/ rotorcraft pilot couplings (A/RPCs) in an aircraft. In general, A/RPCs are “rare, unexpected and unintended excursions in aircraft attitude and flight path caused by anomalous interactions between the aircraft and pilot” [13]. In the past, the key causal factor of A/RPCs appeared to be the pilot. As such, they were initially known as Pilot Induced Oscillations (PIO)<sup>2</sup> and Pilot Assisted

<sup>2</sup> Pilot Induced Oscillation (PIO) occurs when the pilot inadvertently excites divergent vehicle oscillations by applying control inputs that are in the wrong

Oscillations (PAO)<sup>3</sup>. This moniker indicated that the pilot was considered to be mainly responsible for these phenomena. Generally, for modern aircraft, it has become increasingly clear that the pilot is not necessarily at fault and that it is the rapid advance in the field of flight-control-systems (FCS) that has increased the pilot-vehicle system’s sensitivity to the appearance of unfavourable A/RPC events, by creating, along with the intended beneficial effects, unforeseen opportunities for unfavourable interaction (e.g.

(footnote continued)

direction or have phase lag. Since active involvement in the control loop is occurring, pilot induced oscillations will cease when the pilot releases the controls, stops control motion or changes control strategy.

<sup>3</sup> Pilot Assisted Oscillation (PAO) is the result of involuntary control inputs of the pilot in the loop that may destabilize the aircraft/rotorcraft due to inadvertent man-machine couplings. Since passive involvement of the pilot’s biodynamic response to vibration occurs, these pilot assisted oscillations are generally much more dangerous because releasing the controls will not cease the oscillations.

delays, saturations, “disconnection” between the inceptor motion and the actual motion of the control surfaces in higher control modes) [111]. The fact that different pilots may show different degrees of proneness to adverse A/RPC does not absolve the design of the vehicle system from its prominent role played in such phenomena. Recently, high-fidelity ground-based simulations have been used to design the active control systems of modern aircraft. Unfortunately, the simulation testing sometimes failed to uncover certain problems which were only uncovered during in-flight testing [13]. This ultimately led to aircraft damage and loss and the corresponding subsequent expensive system redesign efforts and replacement costs. As the level of system automation is likely to both increase and be extended to smaller aircraft types that, hitherto, have relied on manual control in the future, it follows that A/RPCs are likely to be very different, perhaps more complex and certainly more varied from those encountered in the past. There is therefore a need to draw upon present experience to better understand both the future simulator fidelity requirements needed to unmask A/RPCs and the differences that exist between ground-based simulation and in-flight testing.

The ARISTOTEL project - Aircraft and Rotorcraft Pilot Couplings - Tools and Techniques for Alleviation and Detection (2010–2013) in Europe performed a series of simulator test campaigns to understand and advance the state-of-the-art in the prediction of A/RPC phenomena using flight simulators (in relation to both bio-dynamic and active pilot in the loop testing) [14–33]. The goal of the present paper is to review the findings of the ARISTOTEL project, specifically in relation to ground-based simulator testing to unmask A/RPCs. The project concentrates mainly on APCs of future fixed-wing aircraft involving structural elasticity and on low and high-frequency RPCs of conventional helicopter configurations. In this sense, the A/RPC problem domain has been divided into two regions of interest, based upon the characteristic frequency range of such phenomena. These are: 1) ‘rigid body’ RPCs characterised by low frequency flight dynamics modes (below 2 Hz) with an ‘active’ pilot who is concentrating on performing his/her mission task i.e. closed loop tasks and 2) ‘aeroelastic’ RPCs with excitation modes of vibration with a bandwidth of 2–8 Hz, usually involving a ‘passive’ pilot response.

#### 1.4. Can ground-based simulators reveal the existence of adverse A/RPC?

For rigid-body phenomena, the most common cause of dangerous A/RPCs during demanding piloting tasks is ‘large’ time delays (more than 200 ms) in the vehicle’s control path [26]. Such delays can and do occur in the flight controls of modern aircraft and can result in differences between the levels of command gain and of phase lag [35] desired by the pilots and those resulting in the control laws. Phase lag can be introduced into the pilot’s command path by the flight control system. Contributors include prefilters, structural filters, antialiasing filters, computational delays, actuation lags, etc. This lag can be significant, especially in fly-by-wire (FBW) rotorcraft. Here, typical values range between 70 ms to more than 200 ms, usually as a result of the control stick dynamics. The effect on the pilot’s perception of the vehicle’s response to his/her control inputs as a result of these large delays can be quite dramatic, and can result in dangerous A/RPCs when performing demanding tasks. In such tasks, the pilot must correct errors rapidly with the controls, and even relatively small delays degrade task performance. To do this, pilots must mentally compensate the phase lag by acting as lead regulators, but the amount of lead that can be applied to voluntary control is limited by the pilot’s bandwidth. When the bandwidth of the task exceeds that of the pilot, not enough lead can be used, and the phase margin of the pilot-vehicle system reduces, resulting in a loss of stability of

the pilot-vehicle system. In keeping with this view that the pilot behaves as a servo element in a closed-loop control system, the terminology “high-bandwidth” has emerged for tasks that require frequent and prompt attention. In a high-bandwidth task, the sudden loss of control and A/RPC that can result are also referred to as a flying qualities “cliff phenomena” i.e. there is little or no warning that the phenomena is about to occur. It is therefore of immediate concern for future aircraft to learn to avoid these dangerous “cliff-edges” early in the design process and this can most readily be achieved using ground-based simulators.

It has already been stated, however, that it is unlikely that a flight simulator will ever be able to satisfactorily recreate all of the different elements of an actual flight to the highest fidelity. The specialist literature in this field reveals contradictory evidence for the effectiveness of ground-based simulation facilities as an A/RPC assessment tool. The general view is that ground-based simulators are not reliable in revealing the existence of adverse A/RPC tendencies. This is mainly because [13]:

1. simulators contain distortions of reality due to the simulator visual environment and a reduced level of visual scene texture which alters the piloting strategy used and the overall pilot/vehicle closed-loop performance;
2. there are improper acceleration cues and unrepresentative vibratory environments delivered by the simulator motion platform dynamics which also alter the piloting strategy used and the observed pilot/vehicle closed-loop performance;
3. in many simulation models, there is an inadequate representation of major flight control system (FCS) details, especially inceptors and FCS characteristics that come into play when pilot-vehicle system (PVS) operations are at or near transitions or other conditions that define performance margins;
4. the pilot may have a reduced level of urgency in the simulator environment when compared to the real flight scenario as it is known that the simulation can be halted if necessary. In particular, the simulators are flown by experienced test pilots that tend to adapt very quickly to new aircraft, and they may unconsciously compensate for deficiencies in the PVS system without unmasking the A/RPC event.

However, it is also recognised in the literature that simulators can indeed reveal the existence of adverse A/RPC tendencies. For example, ground simulators were successfully used to understand the A/RPC mechanism involved in, for example, the Space Shuttle Orbiter [40,41], the well-known SAAB JAS-39 Gripen accidents [42,43] and the Sikorsky CH-53E RPC events [44]. Mitchell considers that “ground simulation appears to mask the positive characteristics of good airplanes and the negative characteristics of bad airplanes” [45]. His conclusion is based on the examination of two simulation experiments: the first experiment is related to a simulator replication of the HAVE PIO flight programme [46] conducted in 1996; the second one is related to NASA Ames Research Center [48] simulator testing conducted in 1998. Another study performed in the 1990’s using NASA data from a transport aircraft [35] suggested that motion-base ground simulation does not predict the effects of time delays in the control system for these types of aircraft. Fig. 5 from [35] does indeed suggest that the effects of delays on piloting and PIO tendency can be better seen during in-flight simulation than in ground-simulation.

Celere et al. [52] consider that, in order for simulation devices to act as a valid means to unmask A/RPCs, one has to ensure that, during simulator testing, the test pilot is always in a “high pilot gain” mode and thus he/she should be capable of triggering a PIO. In general, simulator testing experience has shown that the pilot gain can vary significantly. This is especially true towards the end of the

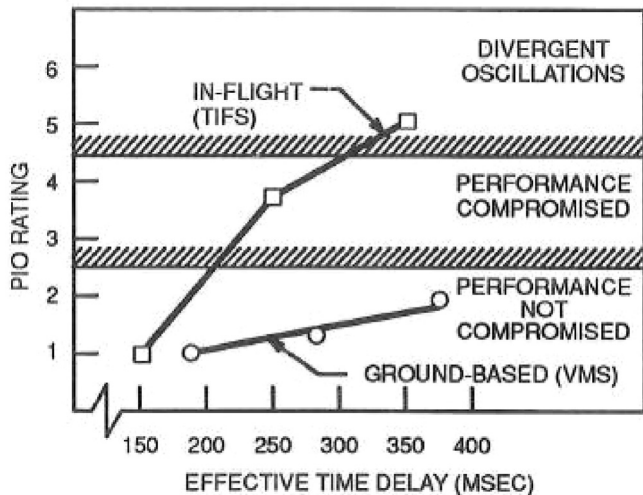

Fig. 5. Comparison of PIO tendency between total in flight simulation (TIFS) and NASA's Visual Motion Simulator (VMS) [35].

flight test sortie when physical fatigue has a strong influence on the pilot's ability. McRuer [13], discussing the prediction of A/RPC in a simulator, found that such devices were able to reproduce some, but not all cases of in-flight experienced APCs. Aircraft configurations which demonstrated 'severe' APC characteristics in flight also exhibited APC tendencies in simulation for all pilots. However, somewhat better performance was seen in simulation than in actual test aircraft. Finally, for APC-prone and APC-resistant cases, major differences in workload and ease of control were observed between configurations flown in the simulator and in-flight.

Overall then, testing for aircraft A/RPC proneness in ground-based simulators must be approached carefully and the results treated with caution. Although flight simulators will likely never achieve the level of reality of in-flight testing, exposing A/RPC tendencies in the simulator may be the only safe place to evaluate the wide range of conditions that could produce hazardous A/RPC events. Flight simulators are presently intensively used in industry for handling qualities assessment although, again, the results achieved are not always completely reliable [46]. Furthermore, flight simulators are considered to be an indispensable tool in the development of any FCS, particularly when used to examine the effects of mode transitions on handling qualities during high gain tasks (this allows the potential impact of A/RPC triggering mechanisms to be evaluated). Quoting Mitchell again from [45]: "As such - and with the trend toward shrinking money for flight testing, for the foreseeable future - simulation will be used increasingly to investigate PIO".

With all of the above in mind, the goal of the present paper is to provide a critical review of the practises to be used for flight simulators in order to unmask A/RPC problems. The paper concentrates mainly on rigid body A/RPC as they involve the active pilot in the simulator but also to the aeroelastic A/RPCs. It demonstrates that, when the testing is undertaken carefully, the results from ground-based simulators can be effective in unmasking A/RPC tendencies. A proper selection of the forcing functions (in the case of biodynamic testing) and proper piloting tasks (in the case of pilot in the loop testing) is shown to be fundamental in detecting A/RPC tendencies. The paper elaborates extensively on not only the simulator motion cueing and visual system requirements but also the control loading and aircraft model characteristics to be used for unmasking unfavourable A/RPC. Useful practises and simulator methodologies are given to assess A/RPC incipience.

## 2. Simulator characteristics relevant to the A/RPC problem

Flight simulators are complex systems that rely on the representation of appropriate performance within their constituent parts (motion, visual and control loading systems, mathematical model, sensor feedback generation, sensory display devices, human operator, etc.). Fig. 6 shows the simulator environment in relation to the human perception environment. The simulator environment (the upper element of the Figure (taken from Ref. [36]) shows the many components of a simulator that need to be considered when assessing the fidelity of a given device. The pilot perception environment (the lower element of Figure (taken from [37]) shows the pilot senses and utilises the simulator environment.

The human operator takes in visual, auditory, proprioceptive, and vestibular information provided by the simulator sensory devices (displays, speakers, G-seat, motion base, cockpit control inceptors, etc.). Each of these will now be briefly dealt with in turn. The benefits of providing motion (or not) in a flight simulator is often a subject of controversy (see more discussion on this in Section 3). However, the primary effect of the motion system is to provide acceleration cues<sup>4</sup> (both linear and angular accelerations), which arrive at the pilot usually through the motion of the vehicle seat. A more detailed discussion of motion cueing for flight simulation is given in Section 3 and further detail can be found in [114,117]. The fundamental premise, however, is that when it comes to the platform motion of a simulator, reproducing an aircraft's actual motion cues accurately would be expensive and, in reality, practically impossible.

Although a function of many complex interactions, the visual cues are provided primarily through vehicle rate and vehicle position displays obtained either from the movement of the outside world visualisation and/or from the pilot displays provided to the pilot. The pilot interacts with the vehicle mathematical model and hence the virtual outside world by moving the stick control inceptors. The simulator control feel system therefore influences the pilot's control strategy [112,113,116]. According to [118], command sensitivity and feel system characteristics are the main factors that affect the precipitation of A/RPC phenomenon. Not included in Fig. 6 is the effect of vibration cueing which can be quite important, especially for helicopter applications.

The multitude of pilot perception/feedback actions that affect his/her performance can be also seen in Fig. 6:

1. The outside visual scene and the cockpit instruments are perceived using his/her eyes.
2. Vection perception relates to motion perceived visually. Vection is a sense of self motion induced solely visually and includes self-rotation ("circular vection") and self-translation ("linear vection").
3. Proprioception perception is the information perceived from within the body. Proprioception is generally considered to rise from the vestibular stimulation (vestibular proprioception) and kinaesthetic<sup>5</sup> stimulation (kinaesthetic proprioception). The vestibular system located in the inner ear can sense both rotations and accelerations of the head.
4. Tactual perception may include sensing information tactilely (through the skin), kinaesthetically (through the joints, muscles

<sup>4</sup> In Webster's Dictionary, a cue is defined as "a feature indicating the nature of something perceived". For simulator, a cue is a cluster of sensory stimuli, acting on the pilot via any of his sensory channels-closely correlated with a characteristic of the airplane and its behaviour, which is relevant to the pilot when flying the airplane.

<sup>5</sup> Kinaesthesia is the awareness of the orientation and the rates of movement of different parts of the body arising from stimulation of receptors in the joints, muscles, and tendons

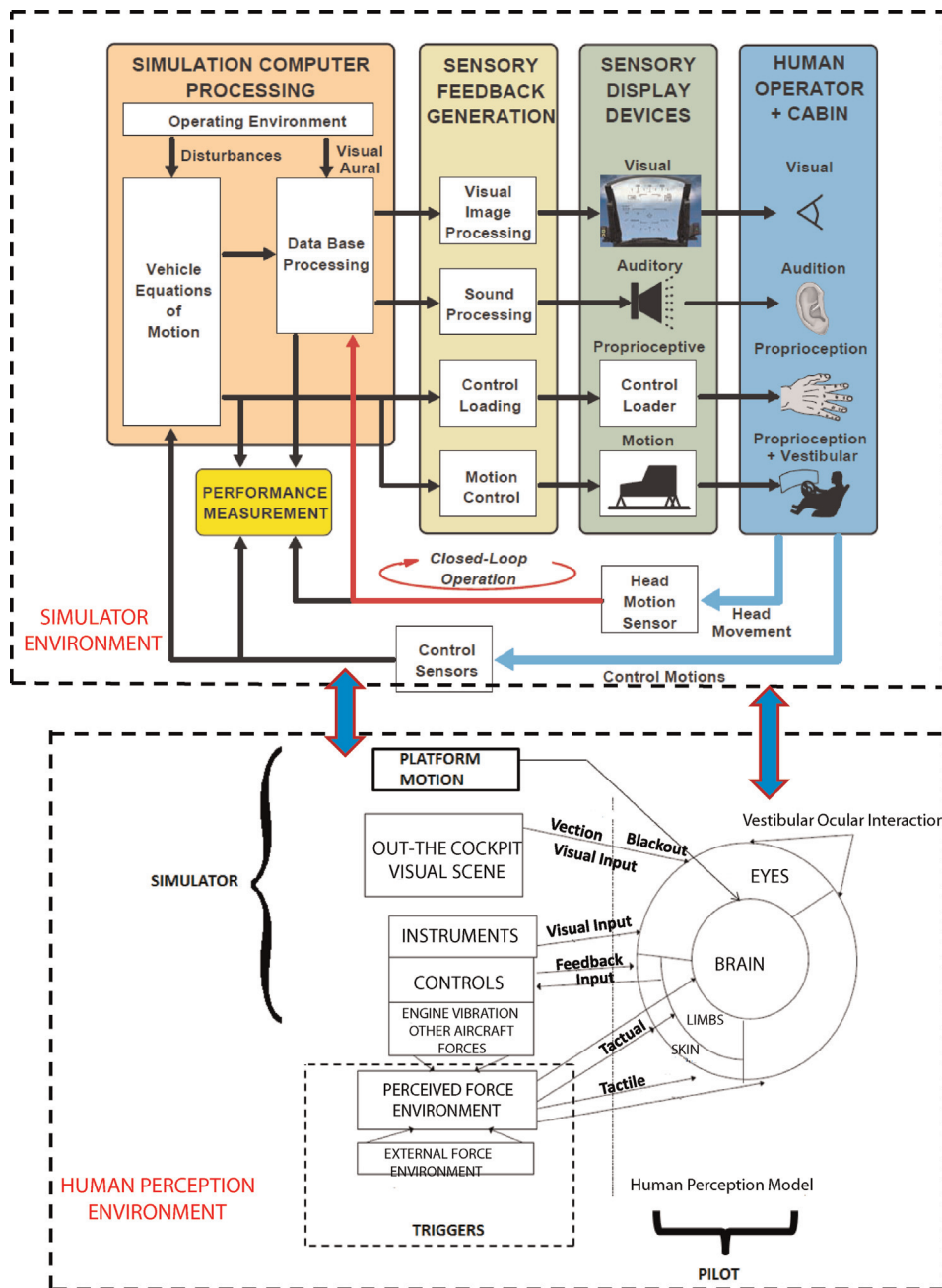

Fig. 6. Schematic of simulator environment in relation to human perception environment [adapted from 36,37].

and tendons), or both. The pressure sensors on the human skin are capable of sensing the vehicle accelerations.

5. Haptic perception is a narrower term that refers to sensing information both tactilely and kinaesthetically. Instances of tactual perception in which there is no tactile component whatever are usually contrived. For this reason, the terms "Tactual" and "Haptic" can usually be used interchangeably.
6. Auditory cues, in addition to being perceived by the ears, may be picked up by proprioception. In the aircraft the pilot perceives forces associated with the aircraft such as engine vibration, and actuation of control systems, through both perception and proprioception.

Note that, in Fig. 6, the human pilot is fundamental to the control loop, and understanding the pilot-vehicle system is important for demonstrating the feasibility and effectiveness of the

ground-based simulators in detecting A/RPC proneness. For example, [38] describes how helicopter pilots perform a hover: On the one side there are important visual cues such as horizon and optical flow<sup>6</sup>; on the other side there is also a pilot 'seat of the pants' feeling involving a combination of vestibular, tactile and neuromuscular cues in order to make his own perception and judgement.

In essence, A/RPCs are coupled Pilot-Vehicle phenomena that are instigated by a trigger [13]. As pilot performance in the simulator is highly dependant upon making the appropriate responses to the cues provided, it follows that, when it comes to

<sup>6</sup> The horizon visual cue relates to the helicopter's orientation in pitch and roll as provided by the horizon. Optical flow relates to the visual flow-field created by features in the external environment that are perceived by the pilot as the vehicle moves.

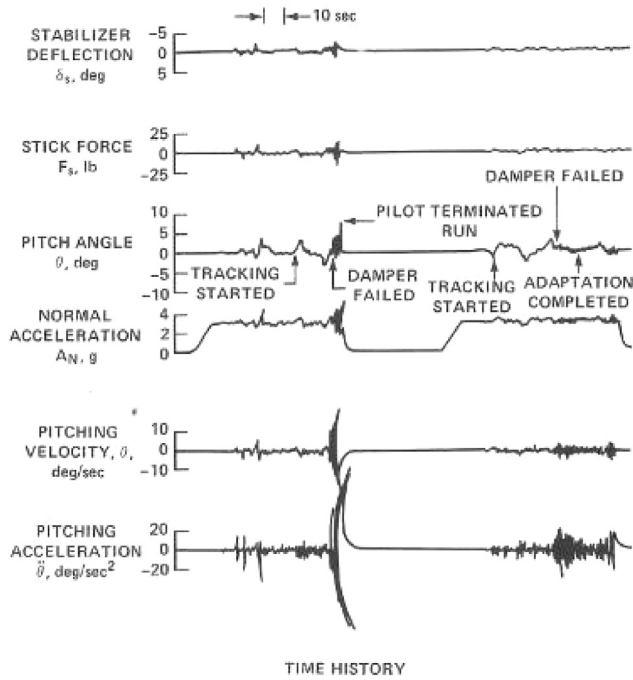

Fig. 7. Moving simulator evaluation of pilot's ability to cope with sudden pitch damper failure [55].

unmasking A/RPC phenomena in the simulator, any deficiencies in the simulation device's cueing environment may act as either a false or an absent trigger for an A/RPC. This deficiency may then account for any differences observed between the A/RPC propensity of the real aircraft and the simulation devices. Sections 3–7 of the paper next relate to the most important components of the simulator, underlining the characteristics that the user should pay attention to when testing for A/RPC.

### 3. Simulator motion system characteristics

The role of the motion system is to provide the acceleration cues that give the pilot early and accurate indications of the aircraft's responses to his/her own control manipulations and also to any unanticipated disturbances. To assess the motion's system accuracy, the user can use the Motion Fidelity Rating Scale [104], see Appendix A1. This scale is a scale from 1 to 10 (similar to Cooper Harper HQs pilot subjective rating scale [81]), with a fidelity rating of 1 indicating that no noticeable deficiencies are seen in the simulator motion cues and 10 indicating that the motion system has serious deficiencies. An extended literature review on the flight simulator (motion) requirements was published in 2010 [39]. This Section is specifically aimed toward assessment of the need for motion cueing when unmasking A/RPCs in the simulator.

Generally, in the simulator community, there has been some controversy between advocates and detractors of motion-based simulators. It appears, in retrospect that much of the conflict stems from the tendency of the two groups to argue their position in a binary fashion i.e. motion either is or is not necessary for high simulation fidelity. It is becoming more evident, as experience is gained, that such dogmatic generalizations are inappropriate. There are some applications for which a motion system is essential and other applications for which motion is not needed in the simulation. Caro [53] considers the distinctions between the various factors that contribute to the need, or otherwise, for motion cueing in simulator-based training operations. Dusterberry and White [54] further discuss the need for large-motion simulator systems

in aeronautical research and development. For example, one of the most demanding simulator applications for aircraft research and development is the study of flying qualities. In this discipline, where the aircraft responses over some frequency ranges are poorly damped, the pilot's ability to operate precisely is greatly dependant on the lead provided by the simulator's acceleration cueing; indeed, in extreme cases (example of prolonged post-stall operation [53]), the pilot's ability merely to maintain control can depend on whether these acceleration cues are accurately reproduced.

For A/RPC prediction, the poor motion cueing algorithms of early simulators have led to a lack of confidence in their usefulness with respect to this problem. Experience has shown that a pilot's control strategy in a particular task is significantly influenced by the presence of motion cues [49–51]. This applies particularly to aggressive or high gain manoeuvres and agile aircraft. Figs. 7 and 8, taken from reference [55], illustrate a PIO in which the pilot's attempts to dampen the high-frequency oscillation actually have the opposite effect and contribute to a divergence of the oscillation. The time histories in Fig. 7 show the pitch divergence resulting from the attempt to stabilise the aircraft in a tight tracking task, after the failure of an artificial pitch-damping augmentator. Fig. 8 indicates that flying in the fixed-cabin version of the simulator failed to include important motion effects that adversely affected the pilot in the real-flight situation; an improvement in the ability of the pilot to deal with the problem was obtained when flying in the moving cabin.

Effects of motion cueing on the task performance in an APC are presented for fixed-wing aircraft also by Schroeder and his team in Ref. [49]. In this reference, the simulator motion platform characteristics were examined to determine if the motion amplitude affected APC prediction. Five test pilots evaluated how susceptible 18 different sets of pitch dynamics were to APCs with three different levels of simulation motion platform displacement: 'large', 'small', and 'none'. The pitch dynamics were those of a previous in-flight experiment, some of which resulted in APCs. These in-flight results served as truth data for the simulation. As such, the in-flight experiment was replicated as far as possible. Objective and subjective data were collected and analysed. With large motion, APC and handling qualities ratings matched the flight data more closely than did small motion or no motion. Also, regardless of the aircraft dynamics, large motion increased pilot confidence in assigning handling qualities ratings. Whereas both large and small motion provided a pitch rate cue of high fidelity, only large motion presented the pilot with a high fidelity vertical acceleration cue. It was only for the large motion case that markedly divergent APCs occurred.

For helicopters, to execute a hover task in a simulator, there is a strong justification for the need for large fore-and-aft displacements. Schroeder [51] reports that when using motion in addition

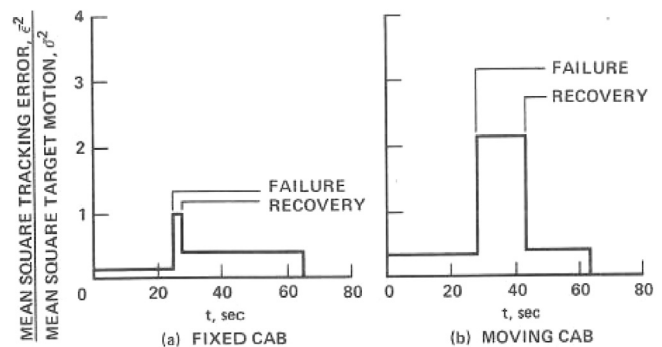

Fig. 8. Effect of simulator motion on an assessment of control problem resulting from pitch damper failure [55].

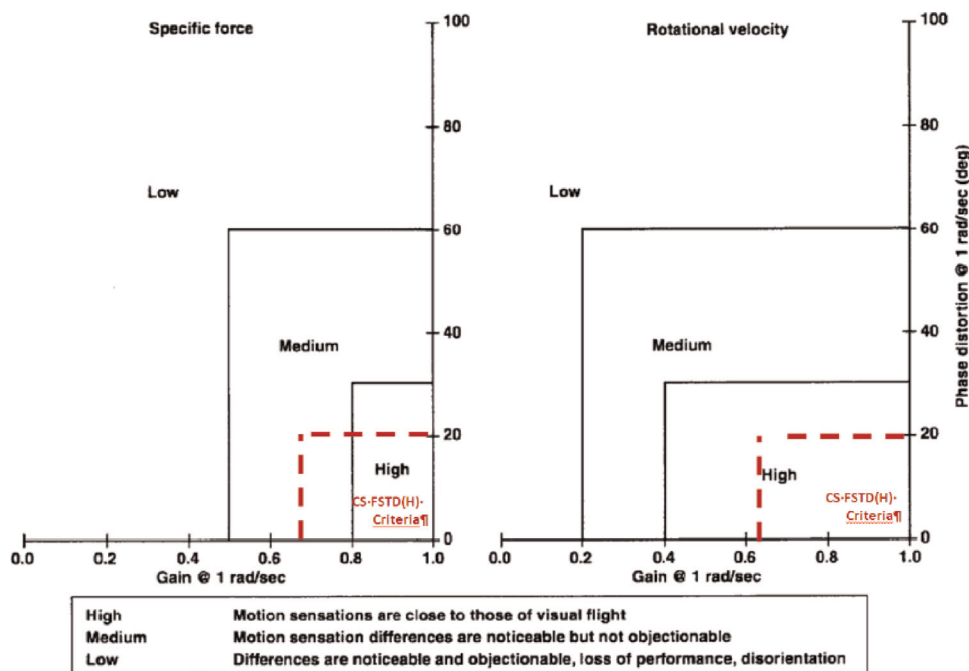

Fig. 9. JAR-FSTD H and Sinacori Motion Criteria at 1 rad/s [77].

to visual cues in a simulator in a vertical task, the pilots more accurately doubled/halved the required steady-state altitude estimation: "Pilots were surprised at the performance results and at how their technique had to change when all motion was removed. Two of the three pilots made collective inputs in the wrong direction when flying fixed base. Until the value of vertical motion was demonstrated, pilot subjective impressions were that the vertical task was primarily visual. Thus, caution should be used when interpreting piloted subjective impressions of the value of motion".

Mitchell et. al. [56] described a number of Mission Task Elements (MTEs), taken from ADS-33 [57], that were flown using two motion configurations. Included in these tests were the Bob-up and the Vertical translation manoeuvres. For helicopters, the presence of motion cueing was found to have a clear effect on both tasks, improving Handling Qualities Ratings (HQRs) [81] in most cases from Level 2 to Level 1.

In conclusion, it seems clear that motion cues aid the pilot in stabilizing and manoeuvring the 'aircraft' by providing feedback and allowing him/her to fine tune his/her control inputs. When considering the reasons why motion cues might be important for the pilot, Heffley et. al. [73] provided an extended description on why and how motion and visual perceptual mechanisms are important and can be modelled for use in determining simulator fidelity. Reference [4] commented that although the non-visual sensing mechanisms through which the human body can detect motion (vestibular system containing the semi-circular canals and the otoliths, the tactile receptors in the outer layers of the skin and the proprioceptive and kinaesthetic sensors in the muscles' signals to the central nervous system) are less precise than the visual sensory system, they may respond more rapidly to the environment, providing lead information, and do not require the direct attention of the subject. This makes simulator motion important, especially when investigating A/RPC cases.

### 3.1. Quantitative motion cueing criteria

The first quantitative criteria for rotorcraft motion cueing fidelity were developed by Sinacori in 1977 [64]. He proposed boundaries on the fidelity of the motion system (defined as

"replication of motion cues felt in actual environment" [49]) for different flight motion frequencies (dividing the problem space into three regions of high, medium and low fidelity) as a representation of gain of the specific force/rotational velocity and phase distortion between the aircraft model and the commanded motion system accelerations. The boundaries were generated using pilot subjective opinion. However, with this criterion, low phase distortion and high gain are required simultaneously. This is very difficult to achieve even with large motion travel simulators and therefore the Sinacori criterion indicates that even sophisticated motion systems such as those of NASA's VMS as having low predicted motion fidelity. The Sinacori criteria were modified by Schroeder [50,51] in order to enhance the pilot's subjective rating of 'realism'.

JAR-FSTD H [66] provides the standards required for helicopter simulator qualification. It contains a number of quantitative criteria to assess simulator motion platforms (and have been carried through to EASA CS-FSTD (H) [68]). These criteria require that, from frequency tests in all 6 DOF axes between 0.1 Hz and 1 Hz (0.63 rad/s to 6.3 rad/s), the phase delay and amplitude distortion must be between  $0^\circ$  and  $-20^\circ$  and have a modulus of  $\pm 2$  dB. For the same tests between 1.1 Hz and 3 Hz (6.9 rad/s and 18.8 rad/s) the phase delay and amplitude distortion must be between  $0^\circ$  and  $-40^\circ$  and have a modulus of  $\pm 4$  dB. The JAR-FSTD H [66] criteria at 1 rad/s (0.63 Hz) (common pilot operating frequency) are overlaid on the Sinacori chart in Fig. 9. It can be seen that the JAR-FSTD H/EASA CS-FSTD (H) requirements are even more stringent than the Sinacori Criteria.

Heffley et al. [73] conducted a detailed study using human operator control theory and pilot comments to determine motion requirements in both failure detection and tracking tasks. It was noted that motion is required to offer a clue to the failure. This is of particular importance in A/RPC when the failure may act as the trigger of an adverse event. It was also found from this study that, for tracking tasks, rotational motion is more influential than translational motion (although the authors warn against the exclusion of translational motion). This suggests that fidelity with respect to translation may be relaxed. Furthermore, it was noted that pilot comments of fidelity changed from one task to another,

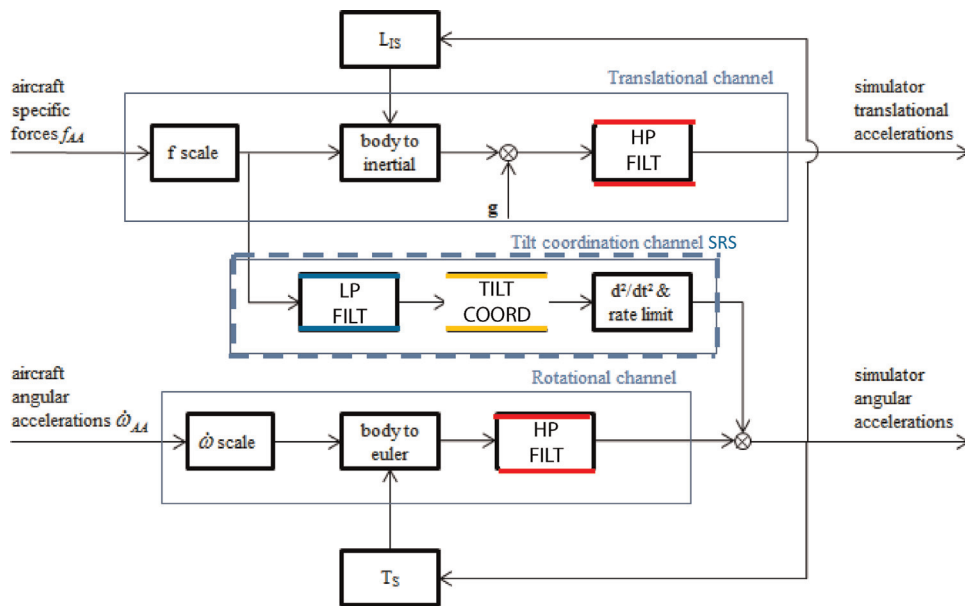

Fig. 10. Washout algorithms in SRS and HFR simulators.

further highlighting the dependency of fidelity requirements on the task being attempted, as mentioned earlier. In general it seems that the effectiveness of motion cueing (and force cueing) for flight simulators depends on task, vehicle dynamics and the properties of the motion cueing itself. References such as [37,98,79] conclude that future studies should carefully document the characteristics of the simulation and the algorithms used for motion cueing. In addition, looking to the future as simulator physical fidelity is supplemented with the notions of perception and cognitive fidelity, a careful analysis of pilot adaptation strategy with respect to the simulator motion will be required [77,78].

Bray [61] analysed the motion and visual cue interdependence in the simulator. For the low-amplitude manoeuvring tasks normally associated with the hover flight condition, the unique motion capabilities of the VMS were particularly appreciated by the pilots flying the vertical-acceleration responses to collective control tasks. For larger-amplitude manoeuvring, motion fidelity must reduce through direct attenuation or through high-pass filtering "washout" of the computed cockpit accelerations, or both. Experiments conducted in height-control tasks revealed that, when holding position in the presence of vertical disturbances, pilot control-gain and the resultant open-loop crossover frequency were significantly reduced as the fidelity of the vertical motion (ratio of acceleration demand to acceleration delivered) was reduced. In a height-tracking of a moving reference task, gain and crossover were not greatly affected, but phase margin and tracking performance improved with increasing motion fidelity. Pilot-opinion ratings of the varied vertical-response characteristics were significantly modified by changes in the motion-cue fidelity. Comparing the visual cues presented in the VMS with those of flight, Bray found that, for helicopter simulations, a non-optimum distribution of field-of-view elements, coupled with a severe lack of near-field detail, compromises the pilot's ability to sense translational rates relative to the nearby terrain or landing surface. This shows that visual and motion cue interdependence is important for the overall perception of simulator fidelity.

### 3.2. Rigid body RPC motion tuning

The generation of satisfactory motion cues in the limited operating envelope of a simulator motion base is achieved by using the so-called 'washout' algorithms (also called 'motion drive

algorithms' or 'motion filters'). These algorithms scale down the desired aircraft-cockpit motion to the available simulator-cockpit motion in the frequency ranges of interest. In particular, the low-frequency characteristic of the human semi-circular canals and the otoliths, below about 0.1 Hz [58], make it possible to 'wash out' motion platform tilt and linear acceleration respectively, by slowly returning the platform to its neutral position without allowing the pilot to detect this motion disparity. The efficiency of the washout algorithms depends on the effective thresholds [59] of the semi-circular canals and otoliths and their respective responses to different combinations of accelerations and velocities. The use of vestibular pilot models [60] to match simulator-cockpit motion to aircraft-cockpit motion is a well-known approach. Fig. 10 presents an overview of the basic operations performed by the washout algorithms used in ARISTOTEL's RPC experiments. It can be seen that the motion filter architecture for both simulators is similar. High pass and low pass filters are used (see Figs. 10 and 11) supplemented by non-linear elements, depending on the system excursion limits and the simulator task.

In ARISTOTEL, two test campaigns were performed to unmask rotorcraft RPCs using the research simulators SIMONA research simulator (SRS) at TU Delft, The Netherlands and HELIFLIGHT-R (HFR) at The University of Liverpool, see Fig. 3. SRS is a motion-based generic 6 degree-of-freedom (DOF) research simulator. Hydraulic power is used to drive the motion system. Tuneable in-house motion cueing algorithms are used to provide suitable motion characteristics for the aircraft dynamics being simulated. The visual field of SRS is currently limited to that of a typical fixed wing aircraft. HFR is one of the generic motion-base 6 DOF simulators available at The University of Liverpool flight simulation facility. The motion platform utilises six electric actuators arranged in a hexapod architecture. The facility features a blended  $210^\circ \times 70^\circ$  field-of-view.

In the SRS simulator, tilt coordination is included to allow for a smoother/ well-coordinated simulator motion during multi-axis aggressive tasks. This is because, unlike individual channel responses, the tilt coordination provides cross-coupled motion cues. Thus, the effects of translation commands are considered in the rotational axes through tilt coordination. However, the tilt coordination algorithms in SRS only use a low pass filter LP FILT, which increases the phase distortion of the resultant response around the mid-range frequencies. Looking at Fig. 10, it can be

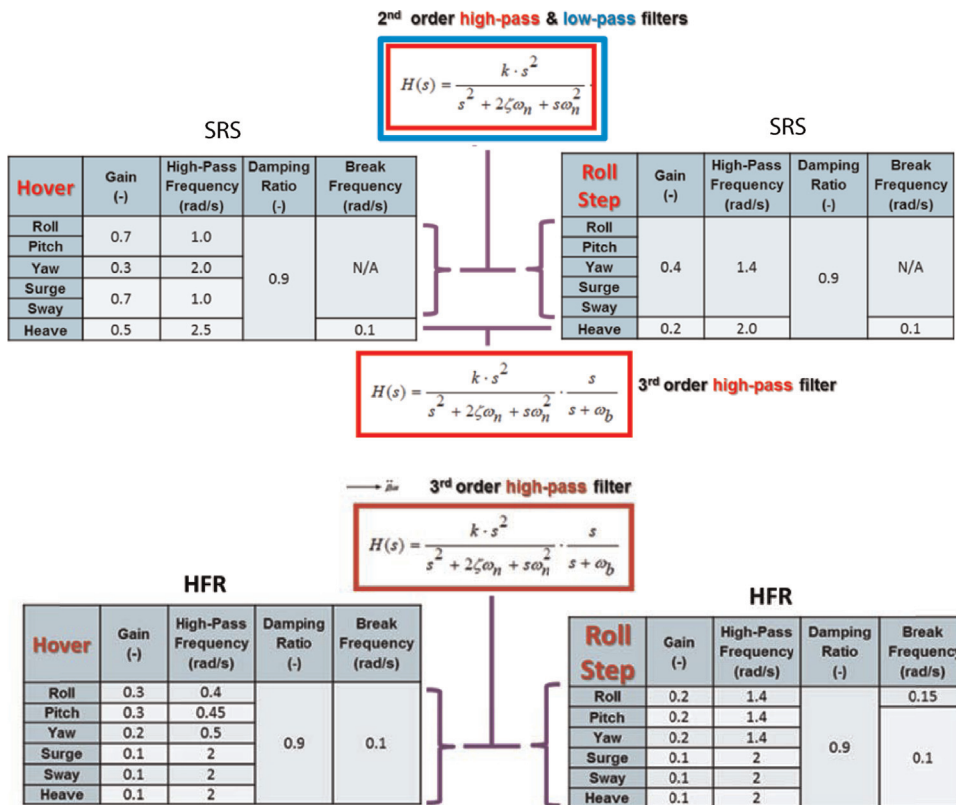

Fig. 11. Motion filter settings of SRS and HFR during 2nd test campaign.

seen that aircraft specific forces  $f_{AA}$  and the angular accelerations  $\dot{\omega}_{AA}$ , computed by the real-time simulation model software in the body-axes reference frame, are the basic inputs to the motion drive algorithms. These forces and accelerations are, after applying Euler transformation, attenuated, limited and high-pass filtered (HP FILT) /low-pass filtered (LP FILT) to generate the simulator translational and angular cues. Lead compensation is also required to compensate for motion hardware dynamic lag. It is achieved by adding first- and second-order lead terms to the position signal of each hydraulic jack.

With respect to the capabilities of the SRS and HFR simulators, Table 1 presents the maximum values of the displacement, velocity and acceleration of their motion platforms. It also presents the motion platforms characteristics of the FS-102 (PSPK) simulator available at TsAGI, Russia and the GRACE (Generic Research Aircraft Cockpit Environment) simulator at National Aerospace Laboratory (NLR), The Netherlands. These latter two simulators were used in ARISTOTEL for fixed-wing APC research. FS-102 (PSPK) has a 6 DOF motion system of the synergistic type that consists of 6 actuators with hydrostatic bearings. GRACE is a modular, reconfigurable transport aircraft simulator for civil flight operations research and prototyping. The simulator has an electrically-driven motion platform. The basic layout of the simulator is based on Airbus A330/340 cockpits. For comparison, Table 1 also presents the motion platform characteristics of the VMS at NASA Ames.

With reference to Table 1, it can be seen that SRS can provide high angular accelerations in its various axes. VMS features significantly large heave and sway motion capability that makes the facility perfect for conducting low speed rotorcraft tests.

The choice of the order and filter values in the washout algorithms was thoroughly investigated in ARISTOTEL. For example, in the first test campaign for SRS, the HP FILT was a first-order filter in the attitude channel, whereas translations were second-order for longitudinal and lateral axes, and a third order filter was used

for the heave axis. A first-order filter for attitude commands was theoretically sufficient for cueing rotational acceleration commands; however, some flying tasks with aggressive and coupled control (e.g. roll-step manoeuvre) led to noticeable simulator drifts, with poor return-to-neutral characteristics of the simulator platform position. As a result, in the second test campaign, the filters in these axes were changed to be second order. A higher-order filter has an improved performance in terms of the return-to-neutral characteristic [62], which is important for simulating aggressive manoeuvres. However, this improved performance comes at the expense of increased phase distortion at low frequencies [63] (phase distortion can be interpreted physically as motion base lag). The motion filter settings values were adjusted according to the tasks performed; their values for the hover and the roll step manoeuvres (see Section 7 for the description of the flying tasks) are presented in Fig. 11.

In this Figure,  $\zeta$  corresponds to the motion system filter damping ratio,  $\omega_n$  is the motion system filter natural frequency and  $\omega_b$  is the first-order pole frequency. From the values of these settings in Fig. 11, it can be seen that SRS had filter gains of larger magnitude than HFR for attitude channels, with larger filter pass frequencies, due to its second order filter structure. The benefit of this is less motion phase distortion but with a higher risk of drift.

An attempt was made to match the response of both motion bases - SRS and HFR - as closely as possible and tune them for each task to be undertaken. The availability of longer leg strokes for SRS could provide a larger possible motion envelope for SRS when compared to HFR. Hydraulic actuators in SRS provided a more powerful motion command when compared to the electric servos of HFR motion. To compare the capabilities of the motion systems for SRS and HFR, the modified Sinacori Criteria [64], as presented by Schroeder [49–51], were applied. Therefore, the information used to apply the modified Sinacori Criteria can be feasibly determined from the Bode plot of the washout filter. The

**Table 1**  
Motion Envelope of research simulators used in ARISTOTEL.

Axis	Displacement		Velocity		Acceleration	
	SRS	HFR	SRS	HFR	SRS	HFR
Pitch	-30.0/20.9°	+31.6/-27.4°	± 28.8°/s	± 35°/s	1000°/s <sup>2</sup> (theoretical)	300°/s <sup>2</sup>
Roll	± 22.3°	± 23.8°	± 29.6°/s	± 34°/s	1000°/s <sup>2</sup> (theoretical)	300°/s <sup>2</sup>
Yaw	± 45.5°	± 27.6°	± 66.4°/s	± 35°/s	800°/s <sup>2</sup>	500°/s <sup>2</sup>
Heave	± 1.1 m	± 0.39 m	± 0.9 m/s	± 0.49 m/s	± 1.50 g	± 1.02 g
Surge	-1.05/1.338 m	± 0.569 m	± 1.71 m/s	± 0.7 m/s	± 1.00 g	± 0.71 g
Sway	-0.68/0.739 m	± 0.5 m	± 1.87 m/s	± 0.7 m/s	± 1.00 g	± 0.71 g
<b>Motion Envelopes of fixed wing aircraft simulators: GRACE and PSPK</b>						
Axis	Displacement		Velocity		Acceleration	
	GRACE	PSPK	GRACE	PSPK	GRACE	PSPK
Pitch	-17.25/16.6°	± 37.8°	± 30°/s	± 30°/s	130°/s <sup>2</sup>	230°/s <sup>2</sup>
Roll	± 17.75°	± 35.1°	± 30°/s	± 30°/s	130°/s <sup>2</sup>	230°/s <sup>2</sup>
Yaw	± 22.05°	± 60°	± 40°/s	± 50°/s	200°/s <sup>2</sup>	260°/s <sup>2</sup>
Heave	-0.41/0.44 m	± 1.23 m	± 0.611 m/s	± 1.1 m/s	± 0.81 g	± 0.81 g
Surge	-0.55/0.66 m	± 1.75 m	± 0.855 m/s	± 1.5 m/s	± 0.61 g	± 0.71 g
Sway	± 0.553 m	± 1.475 m	± 0.855 m/s	± 1.3 m/s	± 0.61 g	± 0.71 g
<b>Motion Envelope of VMS</b>						
Axis	Displacement		Velocity		Acceleration	
	VMS		VMS		VMS	
Pitch	± 36°		± 40°/s		115°/s <sup>2</sup>	
Roll	± 36°		± 40°/s		115°/s <sup>2</sup>	
Yaw	± 48°		± 46°/s		115°/s <sup>2</sup>	
Heave	± 15.24 m		± 4.87 m/s		± 0.775 g	
Surge	(50ft)		± 1.22 m/s		± 0.31 g	
Sway	± 2.43 m (8 ft)		± 2.43 m/s		± 0.5 g	
	± 10.668 m (35 ft)		± 2.43 m/s			

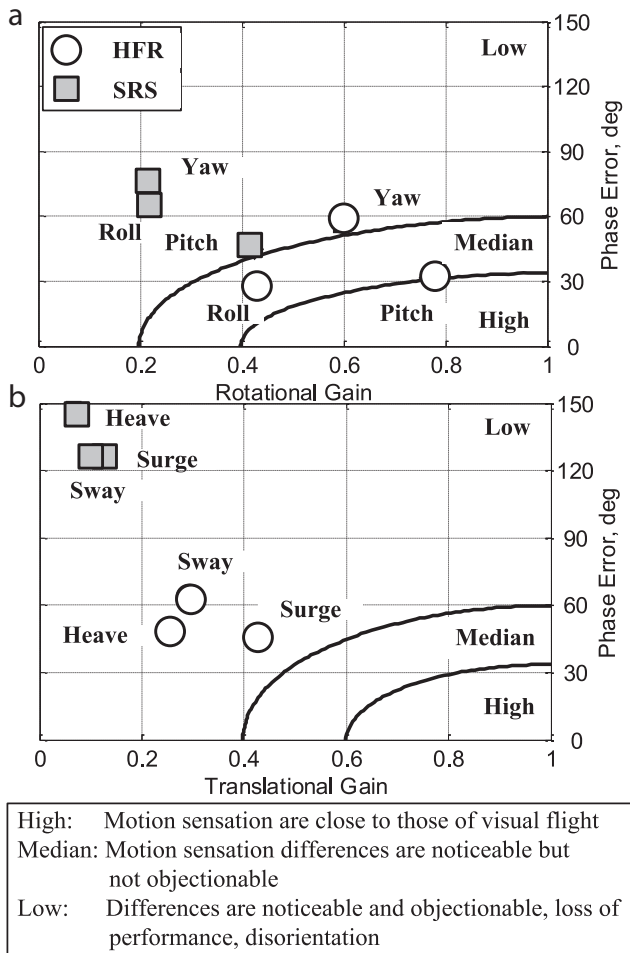

Fig. 12. Motion fidelity prediction in HFR and SRS simulators using the modified Sinacori Criteria [64].

results from the application of the modified Sinacori Criteria to the high-pass washout filters given in Fig. 11 are presented in Fig. 12.

The Sinacori criteria theoretically indicate that a washout filter with a high-gain and a low-phase distortion will result in a lower error between the simulator motion cues and those from the real aircraft motion, and vice versa. Two observations can be made from Fig. 12:

1. First, all of the axes of SRS and HFR simulators are generally predicted to be 'low' fidelity. The exceptions are HFR's roll and pitch axes which are predicted to be of Median fidelity. Both simulators are actually configured to provide small motion ranges to deal with the overshoot of the strokes, with SRS being configured to be slightly more conservative (having a lower gain).
2. Second, the distribution of the results for the two simulators in Fig. 12 is typical of small-motion configurations that have been widely used on hexapods [50].

It should be noted that the predictions of Fig. 12 fail to capture the characteristics of the SRS' larger motion base envelope as presented in Table 1. This is probably due to that fact that this criterion only considers the influence of the washout filter dynamics. Apart from the washout filter dynamics, the transport delays, the motion drive algorithms, and motion platform hardware/software can also have a significant influence on the performance of the motion cueing system.

The result of the subjective measurement of motion cues

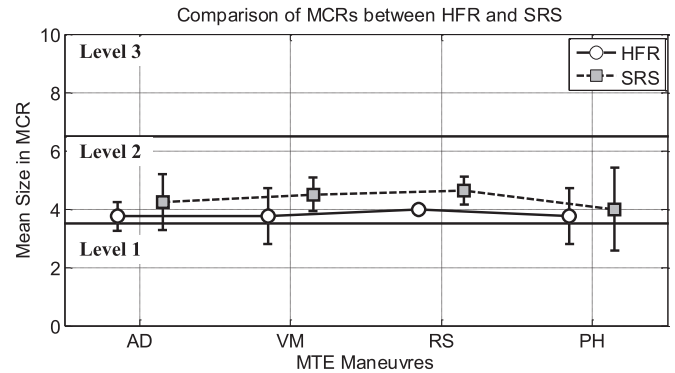

Fig. 13. Subjective motion-cue comparison between HFR and SRS simulators.

through the MCR is plotted in Fig. 13. Four mission task elements (MTEs) that account for the simulators limitation issues stated above, either taken directly or adapted from ADS-33 [57] were chosen to explore the effects of different simulation facilities on the reported RPC susceptibility of notionally similar vehicle configurations. These MTEs are Acceleration-Deceleration (AD), Vertical Manoeuvre (VM), Roll Step (RS), and Hover Manoeuvre (HM). To assess the influence of the system as a whole, the subjective Motion Cue Rating Scale (MCR) [104] as shown in Appendix A1 was used. This new scale developed at the University of Liverpool is based on the same structure as the established Cooper-Harper HQR scale, with a decision tree that leads the pilot, first to descriptors, and then to numerical ratings. The scale measures the combined end-to-end performance of the motion cueing system by examining fidelity requirements in the translational and rotational axes. Further details regarding the development and use of the motion fidelity rating scale can be found in Ref. [104].

The ratings given in Fig. 13 show that the two simulators provide the pilots with a similar perception of motion cues for the four selected manoeuvres (see also Section 4 on the visualisation of these tasks and Section 7 on further description of the tasks) and that both simulators reside in the Level 2 region. The criteria in Fig. 12 show that, theoretically, the two simulators have small-motion configurations. The MCR values here further show that the two simulators are close in their pilot-perceived motion cueing capabilities across the four MTEs being assessed and hence the requirement to make the motion cueing to be similar was achieved.

As guidelines for the motion base settings of simulators to be used in a rigid body RPC exposure test campaign, the following general steps should therefore be taken:

1. The simulator motion base should be adjusted according to the task to be flown. During the first step, the task could be introduced with its nominal configuration (e.g. no RPC trigger, least aggression demand). Motion space and filter settings should be considered as task-dependant, and the user should adjust the proper channel parameters to benefit from the simulator capabilities for the selected task.
2. Further compromise should be carried out for the RPC candidate task. Adjustment of filter parameters should be made depending on the task, with the 'most' RPC-prone task to be flown by a pilot with high gain and aggressive control strategy. Nominal task progression may not stress the motion base enough when compared to a severe RPC case. The motion base should be tuned to give the maximum expected motion cueing within the limits of the available flight envelope. This will mean flying representative manoeuvres at high aggression and adjusting the motion parameters to be 'comfortably' inside the systems tolerable parameters.

### 3.3. Aeroelastic APC motion tuning

The previous Section related primarily to motion base considerations for rigid-body A/RPCs. This Section now deals with the considerations relating to the effects of aircraft structural elasticity when designing the motion system drive algorithms for a simulator. Regarding the aeroelastic A/RPC, one can state that the simulation of such problems should be somewhat easier, because high-frequency accelerations require much smaller actuator strokes than rigid-body accelerations. As such, they do not need much washout; in fact, washout filters usually are low frequency (for example the HELIFLIGHT simulator in ARISTOTEL low-pass filters were at about 0.2–0.3 Hz, depending on the axis), so there is no intrinsic attenuation of amplitude. As a further consequence, phase lead is negligible at high-frequency (well, before low-pass filters, at least). Certainly, the overall magnitude of accelerations is often limited by other requirements; for example, integrity of the flight simulator (i.e. loads) and operating space (i.e. keep away from its boundaries). As a consequence, the overall magnitude is usually constrained by saturation filters, which cut motion demand above some threshold acceleration. This limitation may surface in ways that can be both positive and negative:

- When high-frequency motion is superimposed to low-frequency motion, and their combination reaches saturation, both motions are somewhat affected, in manners often not easy to quantify in terms of frequency content (i.e. in terms of spectral decomposition). For example, an aeroelastic phenomenon occurring during a manoeuvre in the flight simulator could appear less critical just because saturation prevented it from developing up to an amplitude at which it would have been recognized as RPC. The same oscillation, occurring outside the manoeuvre, would be correctly recognized as RPC. One may erroneously conclude that the manoeuvre makes that aeroelastic phenomenon less critical, and this would occur because of a very limitation of the flight simulator.
- When high-frequency motion evolves into diverging oscillations, soon the saturation limit would be reached, and the diverging oscillations would likely appear as a limit cycle oscillation, where the occurrence of the limit cycle is originated by the nonlinearity represented by the saturation itself. Of course, saturation (either artificial, or caused by the physics of the flight simulator actuation) makes the simulator response as a system different from that of the vehicle. However, this is not a very critical limitation, because what matters is the onset of the A/RPC, which is correctly revealed by the system until saturation steps in. Evidently, when noticeable saturation occurs, ground-based flight simulator behaviour differs from in-flight behaviour. Nonetheless, A/RPC proneness unveiling can probably be considered successful and meaningful up to saturation.

During the ARISTOTEL project, the reproduction of lateral accelerations for an “elastic” aircraft exposed to APC-triggering tasks was thoroughly investigated [27–29,31]. It appears that roll and lateral accelerations felt by a pilot play an important role in high frequency aircraft oscillations and can negatively affect piloting performance and the associated HQ pilot rating [29,120]. Thus, the main rule to follow while simulating structural elasticity effects is to ensure that the unsteady element of the simulation cueing environment be as close to the in-flight environment as possible. This means that the lateral accelerations should be reproduced at full-scale. As in the case of a classic motion drive algorithms described above, the reproduction of lateral accelerations uses high-pass filters to reproduce the high-frequency acceleration contributions through linear sway displacements and low-pass filters

to reproduce the low-frequency acceleration contributions using cockpit roll. Experiments conducted in the European project SUPRA (Simulation of Upset Recovery in Aviation) [74] showed that the pilot perception of high-frequency accelerations (namely those related to structural elasticity) depended on the level of background low-frequency acceleration, and this perception depends on the band of frequencies in which the simulator can adequately reproduce accelerations. Experiments conducted in TsAGI’s PSPK-102 simulator as part of the ARISTOTEL project [29] showed that, as the frequency of the imposed accelerations increases, the pilot’s sensitivity to their perception also increases. This relationship is shown in Fig. 14. The figure was obtained as a result of the experiments conducted to study the effect of low-frequency accelerations on the perception of high-frequency accelerations. In the experiments, high-frequency accelerations ( $\omega=4, 12$  and  $18$  rad/s) were imposed on the background low-frequency accelerations. Varying the frequency of the imposed accelerations it was observed that the perception of the high-frequency accelerations depends on the level of background low-frequency acceleration and on the frequency of the high-frequency imposed accelerations. This can be seen in Fig. 14: as the frequency of the imposed accelerations increases, the thresholds values of the imposed accelerations decrease. This means that pilot’s sensitivity to their perception increases as well. This trend depends also on the frequency of the background accelerations. In the experiments, the background acceleration frequency was  $1$  rad/s. The data obtained in the experiments were used to support recommendations for reproducing the high-frequency acceleration component while simulating structural elasticity mode. In this case, the background accelerations are accelerations in the center of gravity, and their frequency is even lower than  $1$  rad/s. The imposed accelerations, i.e. accelerations due to structural elasticity, are of frequencies above  $1.5$  Hz, and their values are much above their threshold value. In other words, the pilot perception of the elastic oscillations does not practically depend on the rigid-body lateral accelerations. This means that the pilot perceives high-frequency component of lateral acceleration only. For the simulator testing, it can be recommended to reproduce only the high-frequency acceleration components (this can be achieved with the help of cockpit displacement in sway).

## 4. Simulator visual system characteristics

In piloted flight, vision remains to be the primary sense for the perception of the real world. In flight simulation, visual systems are important as, especially at low motion frequencies, visual motion cues play a dominant role for successful piloting. With respect to A/RPC, McRuer [13] considered that an excellent visual display system in the simulator is more important than a moving base because instrument-rated pilots are trained to rely upon visual rather than acceleration cues. This is true for large transport aircraft simulations which need detailed presentation of the outside world mainly only during landing and taking off. However, the visual systems necessary for military flight simulation are more demanding as military operations quite often require extended FOVs (both laterally and vertically), way beyond the maximum used in civil aviation and complex scenes are needed for realistic simulation of low altitude flight [75]:

1. the visual information needed to enable precise control during the final stages of an approach must be contained in the near field ( $20\text{--}30^\circ$  below horizon);
2. once in the hover, however, a different reference system is required which comprises lateral and longitudinal references quite close to the aircraft;

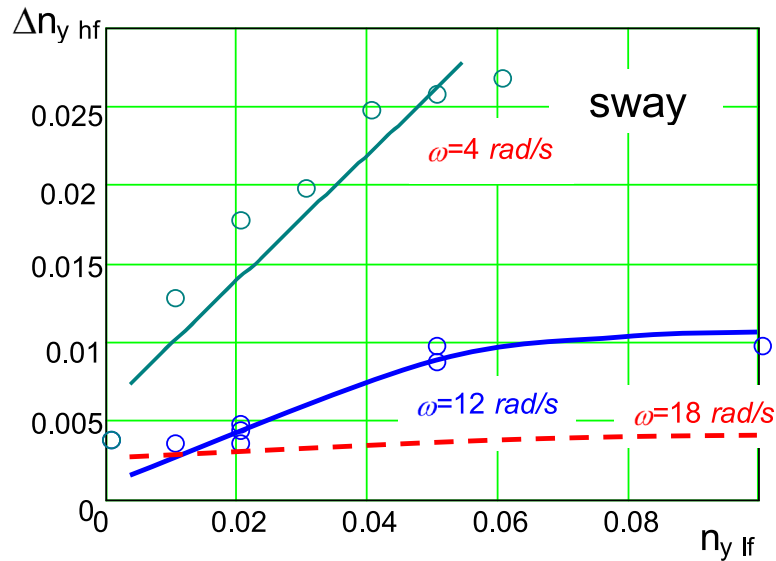

Fig. 14. Thresholds of high-frequency lateral acceleration perception as a function of the low-frequency lateral acceleration [29].

3. low speed manoeuvring requires a particularly good downward FOV, especially on the pilot's side where  $-40^\circ$  to  $-60^\circ$  may be necessary for certain tasks such as deck landings;
4. there is also a requirement for at least a  $90^\circ$  lateral FOV, not only to maintain sight of close-in hover references, but also to judge obstacle clearance in nap of the Earth (NOE) flight;
5. it is also important to be able to maintain sight of the horizon in steep turns and accelerations and decelerations.

One of the major problems for helicopter simulator visual systems is the lack of provision of adequate cues for height and depth perception [75]. The helicopter pilot needs to exploit all of the available FOV as a function of the flight task. Simulator deficiencies in this respect will bring about a change in control strategy at best and an inability to perform a particular manoeuvre at worst.

In ARISTOTEL, the key features related to the visual characteristics of the SRS and HFR simulators are presented in Table 2.

It follows that SRS has a slightly narrower visual FOV than HFR in terms of horizontal visual angles and lacks chin windows, see also Fig. 15. This is because SRS was originally designed as a fixed-wing aircraft simulator whilst HFR is mainly used as a rotary-wing aircraft simulator.

The smaller FOV in SRS had the following consequences during RPC rigid body testing:

- It led to lower Usable Cue Environment (UCE) ratings, especially for tasks that require close ground reference cues (see Fig. 18);
- It generally resulted in worse Handling Qualities Ratings (HQRs) because pilots had difficulties in detecting the adequate and desired boundaries defined for the ADS-33 tasks;
- However, it generally led to more “relaxed” pilot controls which resulted in more masked RPC tendencies (see also the ARISTOTEL results presented in Section 7).

To better understand the effects of visual cueing on helicopter RPCs, the two simulators in ARISTOTEL used the same visual database environments to achieve the same scene content. Therefore, the remaining visual cueing differences must lie in the FOV and display resolution.

Two measures were taken to address the difference in FOV

Table 2

Visual key features of SRS and HFR Simulators.

Items	SRS	HFR
Projector Resolution	1280 × 1024	1400 × 1050
Horizontal FOV	180°	210°
Vertical FOV	40.0°	-40.0/30.0°
Chin window	No	2

between SRS and HFR:

1. the lateral visual angle plays a vital role in providing visual cues for manoeuvres with significant lateral trajectory changes. As such, the planned tests used manoeuvres that contained reduced lateral trajectory changes
2. to deal with the absence of chin windows in SRS, additional visual references were constructed in the visual database to provide the missing ‘close-in’ positional and translation rate cues.

Four mission task elements (MTEs), either taken directly or adapted from ADS-33 [57] were chosen to explore the effects of different simulation facilities on the reported RPC susceptibility. These MTEs were: Acceleration-Deceleration (AD), Vertical Manoeuvre (VM), Roll Step (RS), and Precision Hover Manoeuvre (PH). Their visual description is given in Fig. 13. The individual layout of these manoeuvres is shown in Figs. 16 and 17. The selection of these MTEs had the advantage of reducing the potential negative effect of the smaller SRS horizontal visual angle on pilot performance. There was no significant requirement for wide-angle lateral visual cues to successfully execute the AD and VM manoeuvres. Moreover, the test pilots used for the study commented that the lateral FOV in SRS was sufficient to successfully accomplish the RS manoeuvre and the PH. In addition, as shown in Fig. 17, detailed position reference information was introduced into the visual database to address the absence of the chin windows in SRS. For example, visual objects such as the cones, crosses and lines in Fig. 17c were added to provide the pilot with the necessary position and rate information to perform the stabilisation phase of the Hover Manoeuvre. Additional objects have been introduced into the AD and VM manoeuvres for the same reason.

The visual equivalence between the two simulators was

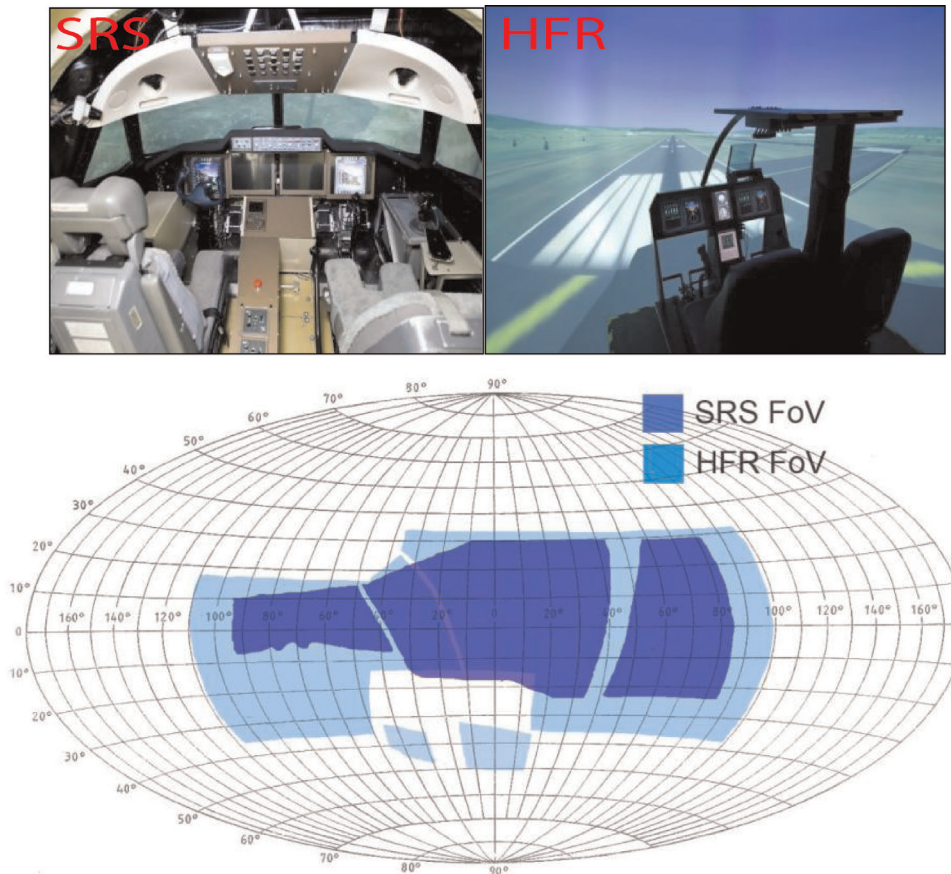

Fig. 15. Pilot view of the outside world from SRS and HFR simulators, right-hand pilot seat.

subjectively assessed using the Visual Cue Rating (VCR) [57], see Appendix A2. The averaged VCRs are then plotted on the Usable Cue Environment (UCE) chart. A series of trials using the selected four manoeuvres were conducted to allow the pilots to award VCRs. Four experienced helicopter test pilots, labelled A, B, C, and D, participated in the experiment. The subjective VCRs and hence UCEs for the four manoeuvres, determined using the process described in [57], are shown in Fig. 18.

As shown in Fig. 18, the VM, HM and RS manoeuvres have been awarded  $UCE=1$  for the two simulators, though the translational rate VCRs in HFR are slightly lower (i.e. improved). The slightly poorer translational rate VCRs awarded in SRS are mainly due to the texture resolution of the test course being slightly lower than in HFR. This presumably results in the detection of the development of translational rates in SRS being more difficult. However, compared with the attitude VCRs, the difference in translational rate VCRs for the VM and PH are not so significant as the VM mainly involves the motion in the vertical axis and the PH focuses on the stabilisation process at very low-speed ( $< 7$  kts). For the AD manoeuvre, the pilots gave similar translational rate VCRs for the two simulators. However, there is the decrease in attitude VCR for SRS ( $UCE=2$ ) in comparison to HFR ( $UCE=1$ ). The pilots reported that this was due to the more restricted vertical FOV in SRS. The AD manoeuvre requires an aggressive pitch-down acceleration followed by an aggressive pitch-up deceleration. The reduced vertical visual cues available occur at the end of the AD manoeuvre in both simulators. The pitch angle required to decelerate is so large that the pilots lost the majority of their pitch attitude cueing in SRS. For HFR, the pilot felt that, whilst also limited, slightly more attitude cueing was available during the final aggressive phase of the manoeuvre. Very little could be done to mitigate this in either

simulator. Overall then, except for the latter part of the AD manoeuvre, the two simulators were subjectively shown to provide a generally similar visual cueing environment for the pilots, with the minor degradation in SRS compared to HFR being due to the wider FOV and higher outside world resolution.

## 5. Simulator control loading characteristics

One of the most sensitive elements in terms of being able to produce A/RPC occurrences in the simulator is the primary flight control system and the associated control loading [13,14]. This has been observed in the ARISTOTEL project especially in the PAO-like cases in which biodynamic effects were crucial in triggering A/RPC. In terms of fidelity requirements, the static force levels and dynamic feel perceived by the pilot in control of an aircraft must be reproduced as faithfully as possible in the simulator, to provide high equipment and environmental cue fidelity. The control forces and displacements felt by the pilot are due to a combination of break-out force and dead-band, spring force, control column inertia, forces due to aerodynamic hinge moments, static friction plus Coulomb and viscous friction [4].

### 5.1. Control loading analysis in fixed wing aircraft

The PSPK-102 simulator at TsAGI included two pilots' stations (left and right) equipped with traditional column/wheels, pedals and side sticks. The latter are located on the left-hand side of the cockpit for the left-seat pilot and on the right-hand side of the cockpit for the right-seat pilot. The standard control loading model reproduces static and dynamic feel system characteristics (in each

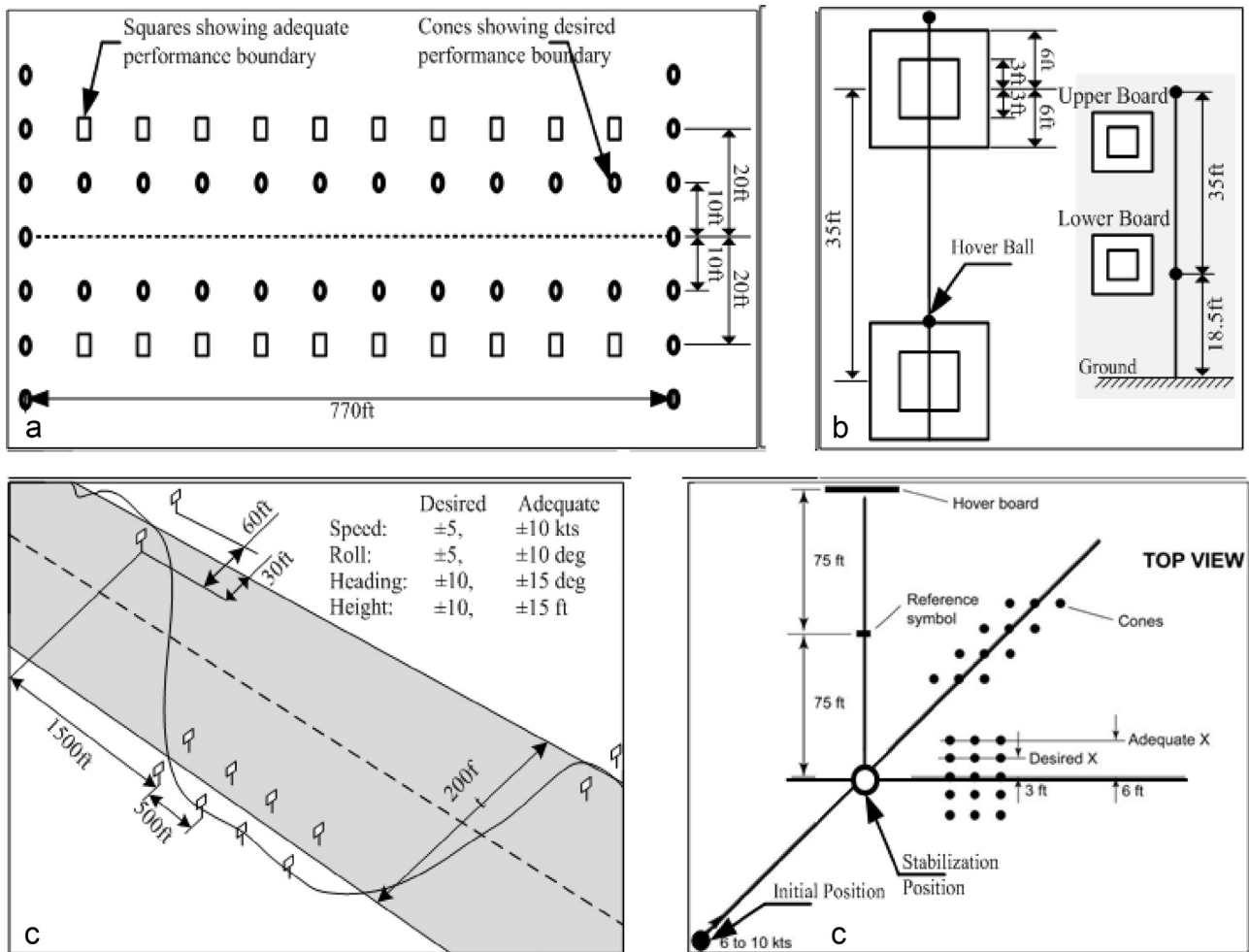

Fig. 16. Layout of four selected MTE manoeuvres: (a) Acceleration-Deceleration (b) Vertical Manoeuvre (c) Roll Step (d) Precision Hover Manoeuvre.

control axis) in accordance with the following equation:

$$m\ddot{\delta} + F_{\delta}\dot{\delta} + F_{\delta}\delta + F_{br}sign\dot{\delta} + F_{fr}sign\dot{\delta} = F_{pilot} \quad (1)$$

where:  $m$  is inertia,  $F_{\delta}$  is damping,  $F_{\delta}$  is force gradient,  $F_{br}$  is breakout force,  $F_{fr}$  is friction,  $F_{pilot}$  is the force applied by a pilot. Three different types of manipulator were used: wheel, side-stick and central-stick. The experiments conducted during the ARISTOTEL project were, in essence, a disturbance task. The manipulator was held in a specified deflected position. The pilot's task was to then visually control the position of the manipulator (the position of the manipulator was not specially displayed, e.g. on the cockpit displays or using the outside view). The task in question is inherent in fixed-wing piloting; for example, in a banked turn, the pilot has to keep the manipulator at a particular deflection to maintain the desired bank angle. An electrical loading system was used for the wheel, the central stick had a mechanical spring and the side stick had a mechanical spring with a damper ratio  $\zeta > 1$ . In the side-stick and central-stick experiments, the deflected position of the stick (a half of the total displacement right or left) and feel system characteristics were constant. In the wheel experiments, the baseline feel characteristics were as follows:

1. for the wheel  $F_{\delta}=203 \text{ N/m}$ ,  $F_{br}=12.2 \text{ N}$ ,  $F_{fr}=7.7 \text{ N}$ ;  $F_{\delta}=27.23 \text{ N/m/s}$ ;
2. for the side stick  $F_{\delta}=100 \text{ N/m}$ ,  $F_{br}=5 \text{ N}$ ,  $F_{fr}=2 \text{ N}$ ;
3. for the central stick  $F_{\delta}=400 \text{ N/m}$ ,  $F_{br}=10 \text{ N}$ ,  $F_{fr}=3 \text{ N}$ .

During the biodynamic tests (these tests were conducted by

applying vibratory excitation to the cockpit occupants without requiring them to undertake any piloting task) and simulator tests (where the occupants were asked to actively pilot the aircraft model), it was shown that the type of control inceptor can play a major role in the pilot-vehicle biodynamic interaction and lead to a dramatic degradation in HQs. The time history for one of the observed APC cases is shown in Fig. 19. In that case, the pilot was required to perform the task presented in the lower plot; the manipulator input is shown in the top plot. The center curves show the lateral accelerations for the rigid and elastic cases of the vehicle model. When elasticity is included, an adverse APC event takes place, as indicated by the high frequency oscillations in the lateral acceleration.

The biodynamic tests performed in ARISTOTEL [27] showed that the biodynamic interaction is especially pronounced for the centre and side stick cases. It should also be noted that, in the piloted experiments, APC cases were observed only for the control system with a side stick; no APC cases were observed when the pilots used a traditional wheel, since it completely decouples the lateral acceleration of the cockpit and control about the roll axis, especially when held with both hands.

It was further shown from the results of the ARISTOTEL test campaigns [27] that the introduction of additional damping into the inceptor loading system can improve pilot ratings (see Fig. 20) by reducing the level of disturbance of lateral accelerations, thus reducing the tendency to APC.

Based upon these results, designers of control systems with side- or center-sticks must pay close attention to the selection of

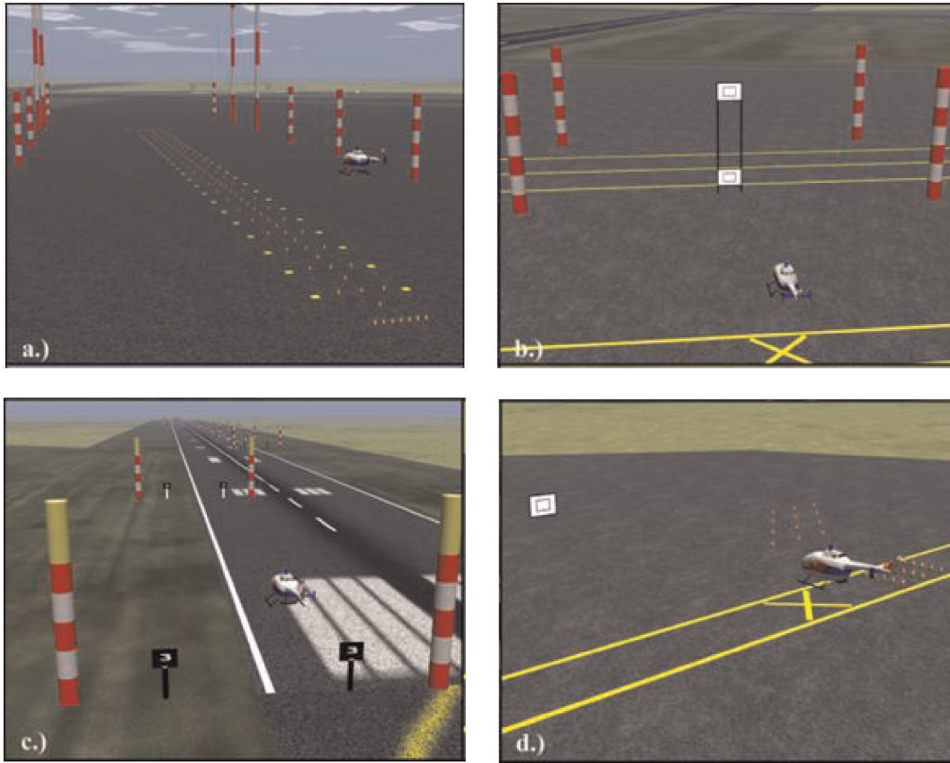

Fig. 17. Visual realization of the four MTE manoeuvres: (a) Acceleration-Deceleration (b) Vertical Manoeuvre (c) Roll Step (d) Precision Hover Manoeuvre.

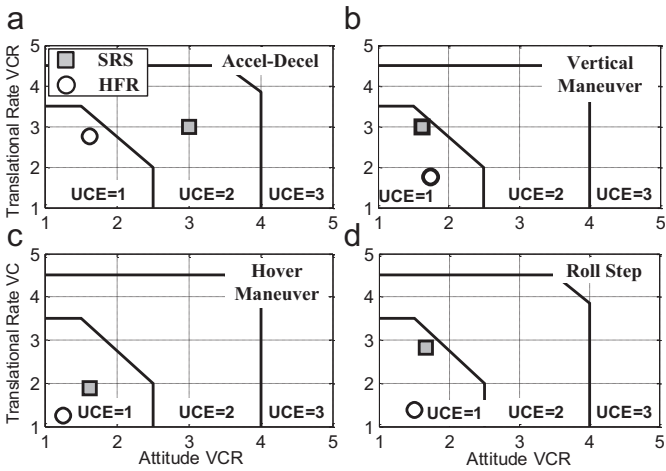

Fig. 18. UCE rating comparison between SRS and HFR simulators [57].

the correct inceptor feel-system characteristics. Alternatively, the inceptor loading system must allow for a wide variation of the parameters (damping, in particular) to be able to select an optimum value.

For fixed-wing aircraft, one particular investigation of interest in the ARISTOTEL project was the analysis of the effects that lateral disturbance accelerations have on pilot ratings. More precisely, it was searched for adverse biodynamic feedthrough (BDF) effects induced by the aircraft into pilot inputs. BDF (also called is biodynamic coupling (BDC)) is the mechanism in which aircraft accelerations cause involuntary pilot limb motions leading to involuntary control inputs. BDF involves coupling between the vibrating vehicle and the oscillatory involuntary control inputs at frequencies close to resonant conditions of the pilot's limb and therefore needs careful investigation. First, the effect of inceptor feel-system characteristics on pilot handling qualities ratings was

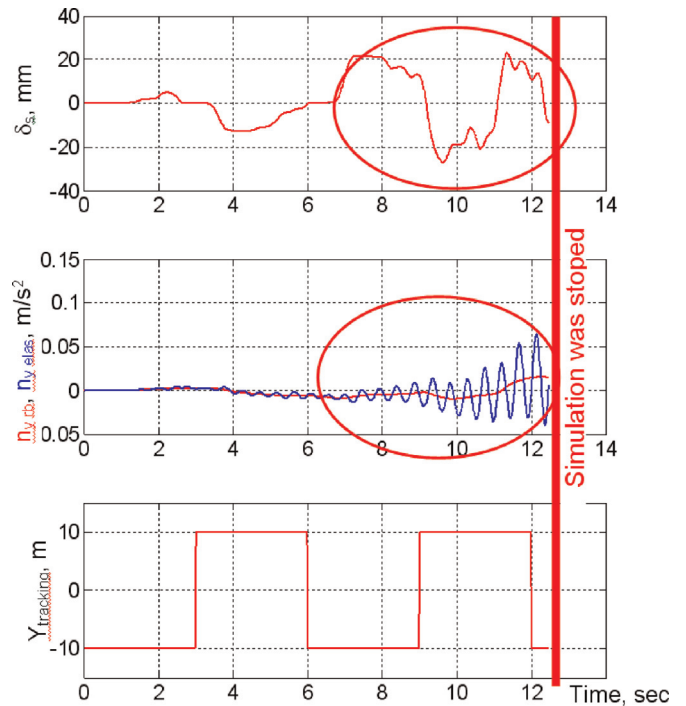

Fig. 19. Example of APC during a side-stick experiment in TsAGI's PSPK-102 simulator [27].

investigated during aircraft lateral tasks. For this, the so-called 'pilot rating worsening criterion' ( $\Delta PR$ ), developed at TsAGI, was used[29]. This criterion allows the estimation of the effects in terms of pilot rating PR degradation depending, in this experiment, on the lateral accelerations experienced. The experiment at TsAGI demonstrated that varying the manipulator characteristics, i.e. using either a traditional control yoke (wheel), a centre stick

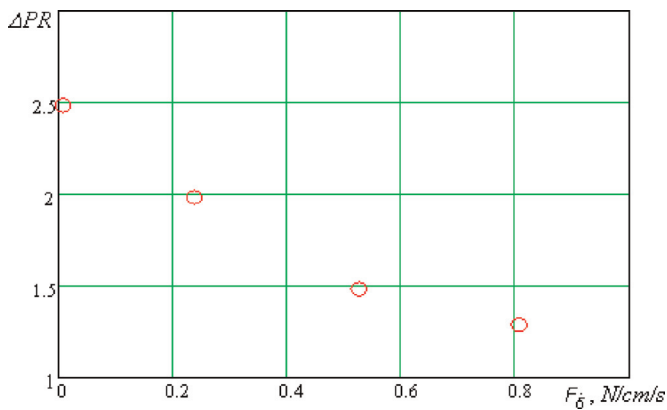

Fig. 20. Beneficial effect of side-stick damping on pilot rating of elastic aircraft [29].

(as in many military aircraft) or a side-stick as in the new fly-by-wire airliners, has a significant impact on the handling qualities and may affect the BDFT. It was found that the greatest pilot rating degradation resulted from use of the centre-stick system:  $\Delta PR = 1.5$ ; with corresponding values of  $\Delta PR = 0.3$  for the side stick system and  $\Delta PR = 0$  for the wheel system. This demonstrates that in many modern civil aircraft (such as Airbus A320 and Airbus A380 that use a side-stick manipulator) and military aircraft (such as Dassault Rafale, F-22 Raptor, F-35 Joint Strike Fighter with a side-stick and Eurofighter Typhoon and Mirage III with a centre-stick) BDFT effects are likely to be important. Also, helicopters and tilt rotors (e.g. V-22 Osprey) use mainly centre-stick manipulators and thus can be more sensitive to adverse BDFT effects [89,90].

## 6. Simulator mathematical model characteristics

One of the crucial ingredients of a flight simulator is its mathematical model representing the vehicle dynamics. Also for A/RPC phenomena, the vehicle dynamics are a crucial ingredient in the pilot-vehicle system. This means that the vehicle system as a whole, including the FCS, displays, actuators, etc., should be reproduced as faithfully as possible in the simulator if its proneness to A/RPC is to be ascertained correctly. The mathematical modelling of the aircraft behaviour in response to control inputs, atmospheric disturbances and system inputs, including failures and malfunctions, is at the heart of a flight simulator. Although this mathematical model can never be wholly accurate, its fidelity, in comparison with the real vehicle behaviour, determines the usefulness of the flight simulator in any but especially A/RPC research. Many papers have been written concerning the required model fidelity to guarantee that a simulation is sufficiently representative to be fit for its intended purpose, for example [80] for helicopters. Also, regulatory authorities have produced functional performance standards - for fixed wing aircraft JAR-STD 1A [65] and for helicopters JAR-FSTD H [66] standards in Europe and FAA AC 120-40B [69] and FAA AC120-63 [70] standards in the United States of America. Since 2009, a standards document was released by the International Civil Aviation Organization (ICAO), the United Nations (UN) agency responsible for international air transport - ICAO 9625. Volume I of ICAO 9625 pertains only to fixed-wing simulators [71]; volume II [72], presently under review, will address helicopter simulators, formalising the qualifying criteria and procedures needed for approval for each of the major components of a helicopter simulator. This also relates to the required fidelity of simulator mathematical models formulated through the so-called "tolerances", i.e. acceptable differences between the simulation and flight test data, typically within  $\pm 10\%$  for flight model tolerances. Of course, these standards are primarily aimed at flight

training devices and therefore assume that flight test data is present, which it may not be in the early phases of an aircraft design project. The present Section is not intended to be a review of the broad area of simulation model fidelity but as a discussion with respect to the effect of mathematical model fidelity on A/RPCs exposure in the simulator. It should be mentioned that there is an ongoing discussion in the flight simulation world related to answering the question "How close should the model be to flight test?" Presently, discrepancies identified by the pilot are most often corrected through a subjective "tuning" process where modifications are applied often to only one component of the system (most often the vehicle model) to compensate for effects being caused elsewhere (for example motion gains and washout frequencies). As a result, the modelling modifications may be physically unrealistic and difficult to justify from the standpoint of a flight dynamics engineer. The strong interconnections between the vehicle model and the simulator systems need further investigation; especially the trade-off between the model's physical accuracy and the overall simulator's subjective fidelity needs to be better understood.

The 'Simulation Fidelity Rating scale' (SFR) [77] was recently developed by the University of Liverpool in collaboration with the National Research Council in Canada and to provide a formalised simulator subjective assessment methodology. The scale is shown in Appendix A3. It is a scale from 1 to 10 (similar to Cooper Harper HQs pilot subjective rating scale [81]), with a fidelity rating of 1 indicating that a task is entirely representative of the simulated vehicle and 10 indicating that the task requires a control strategy entirely inappropriate to the simulated vehicle. The pilot subjective SFR ratings can be therefore used to complement quantitative analyses or provide an assessment alternative where little or no flight test data is available. For more details on SFR scale the reader is referred to [77].

One of the fixed-wing aircraft APC triggers that has been thoroughly investigated in ARISTOTEL is biodynamic feedthrough (BDFT). The level of aircraft high-frequency accelerations is a function of the amplitude, frequency and damping of the structural modes involved in the mathematical model of an elastic aircraft, and directly affects the BDFT. Even though structural elasticity itself was not consciously noticeable to the pilot, its presence in the mathematical model can affect pilot performance and the selection of aircraft characteristics. This can be seen in Fig. 21 representing the pilot lateral stick and vehicle lateral accelerations during the jumping runway manoeuvre (see Section 7.1 for definition and Fig. 23) using the wheel configuration. It can be seen that the addition of the structural elasticity alters the quality of the pilot control activity (the wheel deflections become noticeably smaller).

The 'Control Sensitivity' HQ parameter can be used to capture the way that the high-frequency accelerations, caused by structural elasticity, affect the pilot response. Control sensitivity is defined as the initial angular acceleration of the aircraft following a step input command ( $\text{rad/s}^2$  inch) and is recognized as a primary parameter affecting pilot opinion of aircraft HQs. [76]. In the experiments performed in ARISTOTEL it was seen that, as roll control sensitivity increases, the intensity of the accelerations due to structural elasticity increases and pilot ratings worsen and vice versa, i.e. if the control sensitivity is below the optimum value, the tendency for biodynamic interaction reduces. For an "elastic" aircraft it follows that the designer would select a lower optimum control sensitivity than would be in a rigid-body configuration.

This characteristic of the effect of control sensitivity on pilot response (expressed as aircraft roll mode gain) can be seen in Fig. 22. This figure shows that increasing roll control sensitivity results in worse pilot ratings. The effect of control sensitivity on pilot performance and opinion was also discussed in Refs. [82,83]

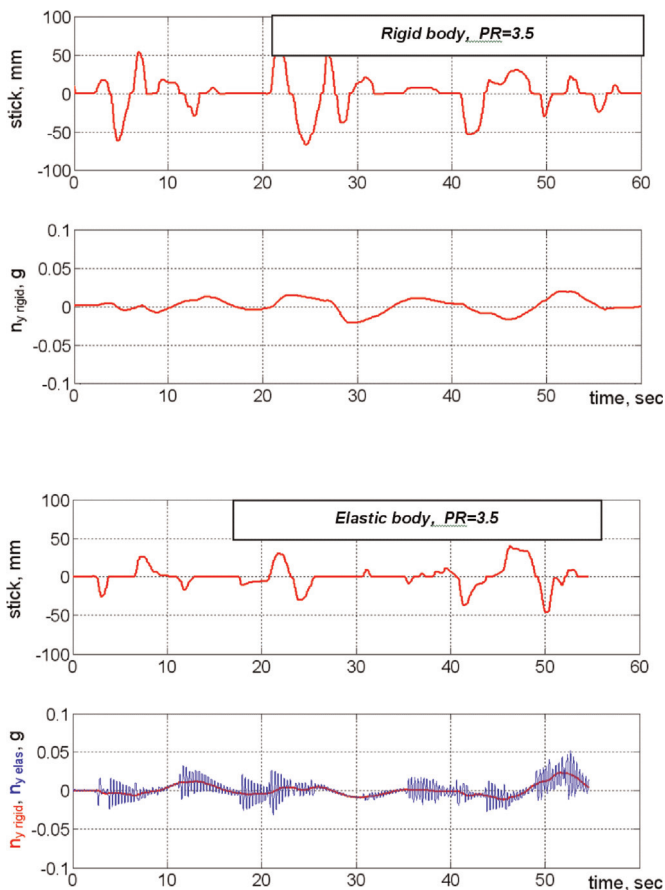

Fig. 21. Effect of structural elasticity on pilot activity. Single 3<sup>rd</sup> mode ( $f=3.0$  Hz). Wheel. “Jumping runway”.

for the roll ratcheting phenomenon. Roll ratchet is an instability caused by the interaction of the arm-neuromuscular dynamics with the roll dynamics. Limited displacement, force sensing sticks seem to aggravate it by lowering the damping of the lowly damped arm-NM mode. The slow roll time constant forces the pilot to push the stick against the stops, bringing the NM mode into play. It seems that, in ground-based simulators, it is difficult to detect the ratchet phenomenon caused by a low roll mode time constant (rigid-body dynamic performance). However, high-frequency accelerations due to structural elasticity are easily reproduced and, thus, their effect can be studied experimentally in simulator tests (again, there is an issue of washout here: low-frequency roll magnitude is attenuated, and significant lead is introduced by the washout filters. On the contrary, higher frequency roll motion is not attenuated, and lead is negligible).

The same effects have been shown in ARISTOTEL with respect to helicopter collective bounce and roll phenomena, where the impact of aerodynamic modelling and structural modes considered in the mathematical model of the Bölkov Bo-105 helicopter affected the RPC/PAO occurrences [25,28]. Specifically, it was pointed out that the significantly damped main rotor coning mode interacts with the vehicle heave motion and the pilot biomechanics associated with the conventional collective control inceptor, whereas the lightly damped main rotor regressive lag mode interacts with rigid-body roll and pilot biomechanics associated with the conventional lateral cyclic stick. In both cases, instabilities at frequencies close to those of the structural mode and of the pilot biomechanics occurred because of a reduction of phase margin leading to a loss of stability after increasing the gearing ratio of the controls and introducing significant but realistic time delays.

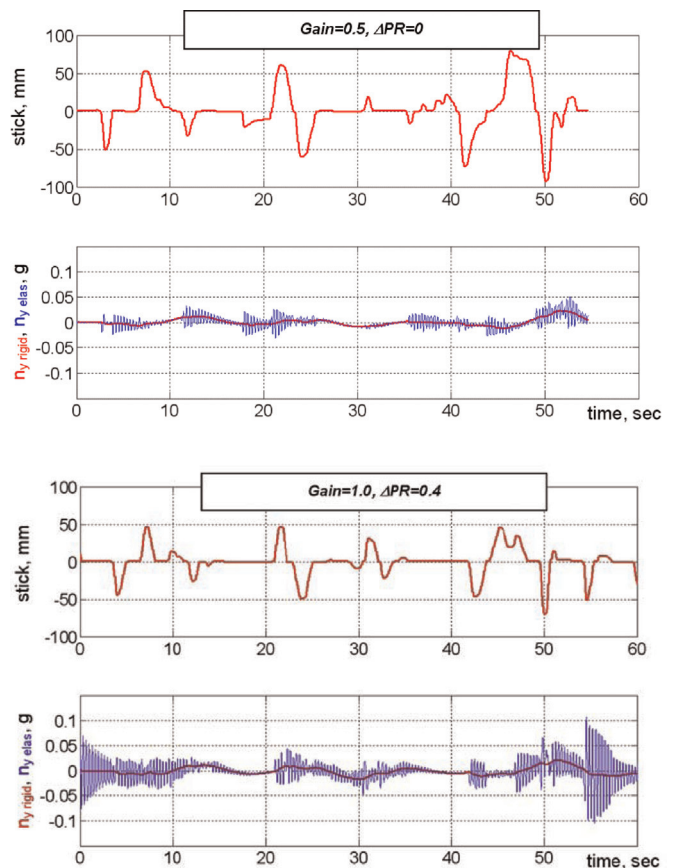

Fig. 22. Effect of control sensitivity. Single 3<sup>rd</sup> mode. Wheel.

## 7. Selection of flight tasks exposing A/RPC tendencies in the simulator

At present, there is a strong industry consensus on the importance of selecting appropriate simulation tasks for detecting A/RPC tendencies in the simulator. McRuer [13] underlines that the tasks selected for simulator pilots should generate high-gain pilot inputs. To generate high-gain tasks, realistic aircraft tasks that naturally maximize pilot gain need to be simulated. A detailed appraisal of task suitability to expose A/RPCs was conducted in the ARISTOTEL project. Findings from this study are outlined in this Section.

### 7.1. Selection of flight tasks for exposing APC in the simulator

For fixed-wing aircraft APC detection, three mission task elements (MTE) in the roll axis proved to be suitable to trigger aeroelastic APC. All these piloting tasks assume abrupt inceptor activity, which results in intense lateral accelerations. These MTEs are:

- **Gust landing** (see Fig. 23): from an initial condition of altitude 262 ft, heading 0, distance from the runway 0.81 miles, at 115 ft altitude introduce a side step-wise left or right (random) wind gust is introduced:  $W_y = 8 \cdot t$  knots at  $0 < t < 3$  s,  $W_y = 24$  knots when  $t > 3$  s.
- **Tracking the “jumping” runway** (see Fig. 23): **The task is to track the runway centre line.** The task is performed at an altitude of 50 ft, heading and bank angle are zero. In the course of the experiment an abrupt movement of the runway to the right or the left is simulated in turns every 20 s. The size of the

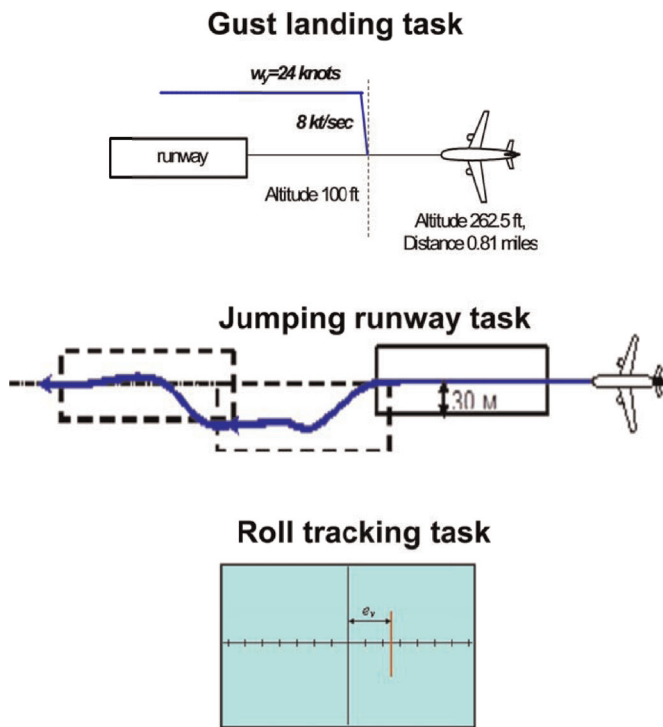

**Fig. 23.** Illustrations of the gust landing task, the jumping runway task and the visual signal for the roll tracking task.

runway movement is equal to half of the runway width (98 ft).

- **Roll tracking task** (see Fig. 23): the pilot's task is to compensate the tracking error  $e_v$  indicated on the display as a moving bar. The visual input  $\phi_{vis}(t)$  given is a sum of sines:  $\phi_{vis}(t) = \sum_i A_i \sin(\omega_i t + \phi_i)$ , where  $i = 1 \dots 16$  with the input signal as shown in Table 3.

Fig. 24 presents recordings made during the course of the three tasks for the aircraft landing configuration. The configuration of the aircraft was as follows:

- side-stick inceptor type;
- feel system characteristics as follows: force gradient 6 N/cm, damping 0.27 N/cm/s, breakout force 4 N, no friction;
- structural elasticity: 1<sup>st</sup> elastic wing mode included;
- roll control sensitivity: optimum value.

It is seen that the selected flight tasks provoke high-frequency accelerations due to structural elasticity and, thus, can be recommended for purposes of demonstration and selection of aircraft characteristics and control inceptor feel system characteristics. The more intense accelerations arise while performing the roll tracking task. Though the task is far from typical practise, its use can lead to quicker results in terms of APC detection, since one of the triggers for APC to occur is the level of the high-frequency accelerations.

## 7.2. The Adverse Pilot Couplings Rating (APC) scale

For rotorcraft rigid-body RPC detection, two test campaigns were completed in the SRS and HFR simulators. The campaigns were staged over four weeks, utilising the two full motion simulators and 4 qualified test pilots (denoted A, B, C and D in what follows). The Bölkow Bo-105 helicopter was used as the baseline helicopter model for this testing. This helicopter is not reported to be RPC-prone. Therefore, PIO triggers were introduced into the

**Table 3**

Numbers ( $n_i$ ) and frequencies ( $\omega_i$ ) of each of 16 harmonics, their amplitudes ( $A_i$ ) and phases ( $\phi_i$ ).

$n_i$	$\omega_i$ [rad/s]	$A_i$	$\phi_i$ [rad]
3	0.2301	1.0	5.9698
7	0.5369	0.95	1.4523
11	0.8437	0.8	3.8129
17	1.3039	0.55	3.0535
31	2.3777	0.26	5.6002
47	3.6049	0.14	4.7884
59	4.5252	0.095	2.8681
83	6.3660	0.065	0.1163
109	8.3602	0.041	5.1611
137	10.5078	0.032	2.7942
157	12.0417	0.025	3.8669
191	14.6495	0.019	4.9759
211	16.1835	0.017	5.7919
239	18.3311	0.014	4.6383
281	21.5524	0.011	1.1075
331	25.3874	0.0085	2.5491

pilot-vehicle system to trigger PIO phenomena. The triggers took the form of transport time delays ( $\tau_d$ ) of 0 ms, 100 ms, and 200 ms. These were introduced into the main control axis control path for each manoeuvre. Alternatively, rate limiting elements were also introduced into the longitudinal/lateral control system. The manoeuvres involved in this rigid body test campaign are those described in Section 3 and shown in Figs. 16 and 17 and Table 4. At the beginning of the experiment, each pilot was briefed on the tasks to be performed and was provided with time to conduct a familiarization flight in each of the facilities. Each configuration for a manoeuvre during the test was performed three times. Finally, after three runs, the pilot was requested to award two ratings – a HQR using the traditional Cooper-Harper handling qualities rating scale [81] combined with the pilot-induced oscillations rating scale PIOR [87] as presented in Appendix A4.

During the test campaign, some problems were experienced with the use of the PIOR scale, some of which have been previously highlighted in references [40,85–87]. From the investigations that were undertaken as part of ARISTOTEL, the main problems identified were as follows [33]:

- A lack of the available subjectivity in the scale i.e. pilots did not feel that the ratings that they were providing matched the corresponding situation that had unfolded. Unlike the HQR scale, the PIOR scale decision tree offers the pilot very little subjectivity. Pilots are trained to apply subjectivity, but are almost forced not to. If the pilot follows the decision tree based on a simple appraisal of what happened during the test, they are forced towards a numerical and descriptive rating. On many occasions, the description was found to be inconsistent with the experience during the evaluation run. With each strand of the decision tree leading to a different rating, changing to a different rating invalidates the decision tree, rendering the results obtained inconsistent.
- The apparent mismatch between the decision tree and the descriptive terms. In its original incarnation, only the decision tree was presented as part of the PIOR. However, in order to improve the interpretation of the results, descriptions were later 'fitted' to numerical ratings. In some studies, only the descriptive terms are used. This creates an inconsistency between investigations conducted using the PIOR scale. One of the main issues that was found during the ARISTOTEL rigid body test campaign was the mismatch between the tree and the descriptions. Pilots often felt that the tree took them to the 'wrong' description; a common occurrence was arriving at PIOR

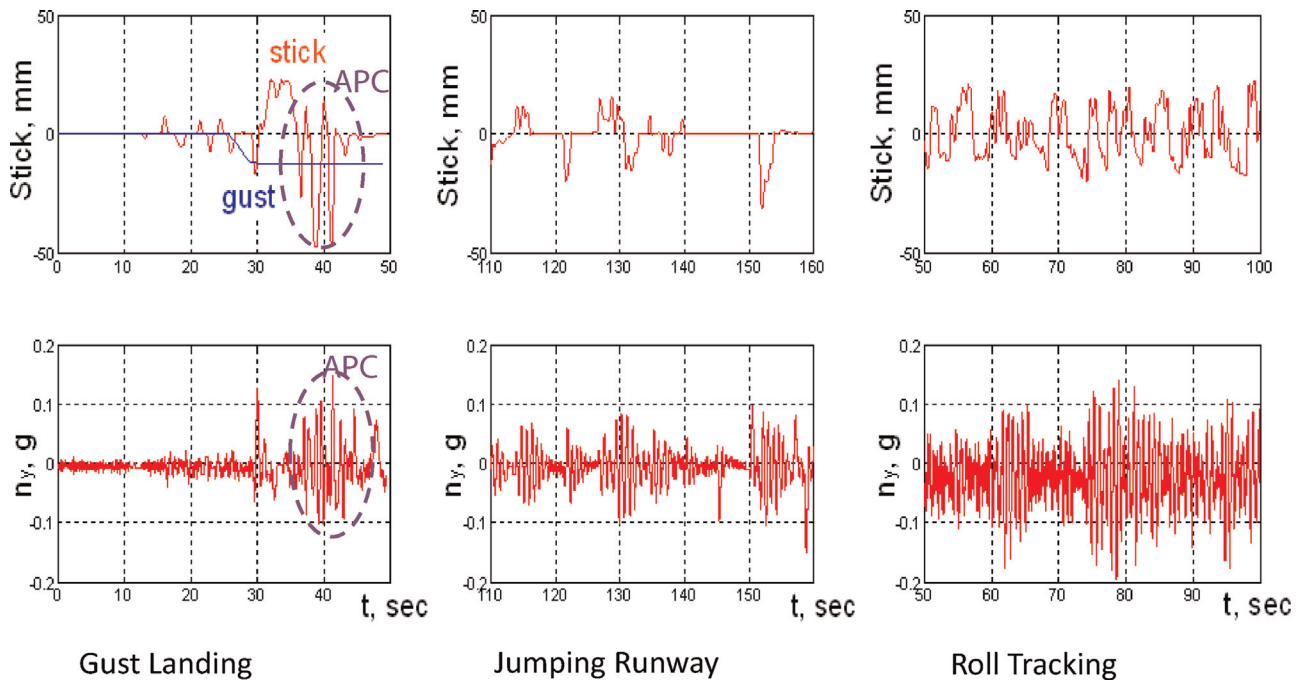

Fig. 24. Recordings of time histories APC tasks in ARISTOTEL. Side-stick. 1<sup>st</sup> elastic wing mode.

4, whilst wishing to use the description of PIOR 3. A major issue is that the end result from the application on the scale is often the assessment of a single number. The meaning of that number is very dependant on whether the descriptive terms have been used. Often  $PIOR \geq 4$  is used to denote observed PIOs. However, there is nothing in the scale to say that 'undesirable motions' cannot be classed as PIOs. What if the pilot does not need to reduce gain or abandon task to recover? What if he/she must only change strategy to counteract PIO?

- The scale gives little justification for the meaning of the numbers. Furthermore, the significance placed upon convergent/divergent oscillations, one of the most challenging elements to assess, makes the analysis of results very difficult. If the pilot feels that convergent oscillations have occurred after entering tight control, no matter what the severity, they must award PIOR 4. It is possible that these oscillations have caused a loss of control. This makes it very important to complement PIORs with HQRs.

Therefore, to try to overcome these issues, a different A/RPC assessment scale was developed proposed in ARISTOTEL, the so-called "Adverse pilot couplings rating" APC scale. This scale was designed to provide greater insight into the danger experienced from unwanted oscillations. The APC scale is shown in Appendix A5. It is the result of several iterations which were modified based on pilot comments and feedback and the need to provide a more robust means of conveying APC test information both to the test team and as a record for posterity. The scale is divided into three key regions (that may be considered as levels). The 'desired' level contains only one rating,  $APC=1$ . This level refers to an aircraft which, during a specifically defined task, did not exhibit any undesirable or unintentional responses. The second region characterises A/RPC tendencies experienced during (attempted) completion of a defined MTE. It contains 6 numerical ratings ( $APC=2-7$ ). It should be noted that the MTE may have been pre-defined, or it may have been an unexpected event. Nonetheless, the pilot should be able to define a 'task' for which A/RPCs occurred after the fact. Ratings in this region do not necessarily all require corrective action on the vehicle or its systems. The wide spectrum of

A/RPCs that could occur during the task are contained within this region. The third and final region of the scale characterises A/RPC tendencies experienced after the (attempted) defined MTE. This includes both open-loop control of the vehicle and flight of the vehicle outside of a task. A/RPCs in this region should always be considered to require further corrective action.

Pilots enter the scale from the bottom left hand corner, and in order to reach the desired  $APC=1$ , they must answer 'NO' to all of the 'top-level' questions. Upon entry to the scale, the pilot is first asked to assess whether any uncontrollable or unpredictable motion (a term which includes oscillations) occurs on entry to the control loop. If the pilot believes he/she has experienced these motions, he/she is referred directly to two descriptions, for which the most appropriate is selected to describe their experience. If the pilot is able to start the task, but this causes unintentional oscillations or motions, they may award  $APC=2-7$  inclusive. The pilot is now in the second region or level. At this stage, the terms 'non-oscillatory motions' and 'oscillations' are placed in parallel, rather than in series as shown in the traditional PIO scale. The pilot must decide whether he/she experienced actual oscillations or oscillation tendencies. If the pilot feels that only 'non-oscillatory motions' were experienced (defined as "vehicle translational or rotational response due to pilot control"), he/she may award  $APC=2$  or  $APC=3$ . These ratings suggest that a PIO tendency exists. Unintentional motion implies that the vehicle has PIO-incipient qualities. However, whatever task the pilot was doing has not forced him/her into an actual PIO situation. This may mean, for example, that the pilot has not reached the important 'PIO' trigger situation. If the pilot experiences oscillations, defined as "periodic control and vehicle motions exhibited during closed-loop flying tasks", he/she may award  $APC=4-7$  inclusive. The pilot can decide the specific rating to award based on his/her experience during completion of the task. Furthermore, the associated descriptions should motivate the pilot's choice. In the APC scale, ratings range from 'mild oscillations' to 'severe oscillations'. Additional terms are used in order to ensure pilots show consistency, by relating the severity of oscillations to pilot workload and experience. The pilot is asked to assess the severity of the oscillations experienced based upon the levels of control 'adaptation' necessary following the

**Table 4**  
Task suitability for RPC testing for the tasks conducted in ARISTOTEL.

Manoeuvre	Proposed RPC Uses	Use in Handling Qualities Research	Positives	Negatives	Considerations
Precision Hover (PH)	Incipience in all axes, predominantly roll and pitch, hover	Check ability to maintain precise position, heading and altitude following transition from translating flight	Clear increase in PIO susceptibility with increasing time delay (roll and pitch) Multi-axis task appears suitable for exposure of PIOs in all axes (Pitch, Roll, Yaw, Heave) Suitable for assessment of cross-couplings	Lack of high gain pilot control demand after hover board capture Requires large visual FoV to adequately capture ground references	Alteration of hover board size Additional disturbances to force pilots to achieve tighter control during the stabilisation element
Vertical Manoeuvre (VM)	Incipience in heave and yaw axes, hover	Assess heave axis controllability, adequate damping and undesirable couplings	Reduction in handling qualities and increase in PIO susceptibility with increasing time delay	Highly scattered PIO ratings, due to significant cross-coupled vehicle model Task aggressiveness showed limited differences in subjective ratings Highly predictable, pilots were able to complete with open-loop control even with high triggering configurations Additional side walls did not improve the pilot compensation effort Requires large horizontal field of view to complete manoeuvre successfully	Manoeuvre suitability in question when off-axis stabilisation is required Autocompensation for cross couplings to achieve a higher HQ rotorcraft model Additional disturbance to force pilots to achieve tighter control
Slalom (S)	Incipience in the roll axis, forward flight	Check for the ability to manoeuvre in forward flight and objectionable cross-couplings			Variable distance between slalom poles could reduce predictable nature of task Manoeuvre suitability in question when limited horizontal FoV
Sidestep (SS)	Incipience in the roll axis, hover and low speed	Lateral direction handling qualities for aggressive manoeuvring and undesirable cross couplings	High control activity in lateral axis Clear tendencies for PIO		
Roll Step (RS)	Incipience in the roll axis, forward flight	N/A	High control activity on lateral axis Increase of HQR with increasing time delay	Difference in course specifications at different Facilities High aggression requires large simulator motion travel (or low motion gains)	Standardise roll step course Adjusted motion filters to ensure preservation of motion travel margins
Roll Tracking (RT)	Incipience in the roll axis, hover and forward flight	N/A		Scattered PIO ratings Unnatural single axis no motion task with high bank angle commands Hard for pilots to distinguish commanded roll and the vehicle response Limited time for pilots to achieve commanded bank with the vehicle model	Redesign of the task commands with vehicle capabilities Visual design desired and adequate boundaries
Acceleration/Deceleration (AD)	Incipience in the pitch axis, hover and low speed	Longitudinal handling qualities for aggressive manoeuvres and undesirable couplings	'Explosive' PIOs obtained during the stabilisation element of the task with time delays and rate limits Largely successful at exposing RPCs due to rate limiting elements	Requires large vertical FoV Difficult task to achieve, particularly for rotorcraft with large cross couplings Boundary width allowed pilot to operate open-loop with certain control strategies Has the potential to lose 'realism' from rotorcraft tasks Requires Head up display	Provide additional cueing to pilots Manoeuvre suitability in question when off-axis stabilisation is required Either apply external forcing function on aircraft/boundaries or decrease the boundary width to force pilot control gain
Pitch Tracking (PT)	Incipience in the pitch axis, hover and forward flight	N/A	Easy to implement and easy for the pilot to understand performance requirements		

triggering of the oscillatory behaviour. This refers to ‘adaptation’ required from their control strategy prior to the oscillations being triggered. If the pilot needs not apply any changes to his/her control or task strategy, this represents negligible pilot adaptation (i.e. he/she did not need to respond to the oscillations). Considerable pilot adaptation refers to the situation where the pilot must consciously act to suppress the oscillations, but may have spare capacity to complete some other tasks (multi-axis control/task requirements). Pilots must decide what constitutes ‘Moderate’ or ‘Severe’ oscillations. This could be based upon the amplitude, frequency or operational situation in which the oscillations occurred. The severity is indicated by assigning a letter to the rating. These ratings describe what has happened during the completion of the task. However, when an A/RPC event is encountered, task performance may or may not degrade. This information is not conveyed when using ‘traditional’ PIO scales. An innovation in the APC scale presented here is the ability for pilots to convey failure to maintain task performance. This is through the ‘Note 1’ path shown in the APC scale. Note 1 states: “If oscillations experienced during MTE cannot be suppressed without opening the control loop, pilot may follow path. Once path is followed, pilot must award alphanumeric rating for their experience whilst attempting task”. If the pilot cannot complete the task, or is no longer engaged in the task, he/she may also include APC=8 and APC=9 in his/her assessment. This includes the situation where the pilot dis-engages from the task but does not fail to maintain task performance. For example, it has been observed that it is possible for the pilot to open the control loop whilst not abandoning the task and completing it to some degree of success. Furthermore, ‘Note 1’ uses the statement, “may follow path”. If the pilot does not consider the oscillations worth it, he/she may remain in the ‘second level’.

When the scale was used in the ARISTOTEL test campaigns, additional descriptive terms were placed on the scale itself to assist the pilots in the decision making process. This was done as a measure to ensure pilot consistency; not for the current investigation, but for the future use of the scale. The terms are as follows: Unintentional - Vehicle response which the pilot did not intend to induce through their control strategy; Undesirable - The vehicle motions are unwanted, and adversely affect task performance; Motions - Vehicle translational or rotational response due to pilot control; Oscillations - Periodic control and vehicle motions exhibited during closed-loop flying tasks. However, based upon pilot feedback, it became apparent that these descriptions made the scale ‘test-card’ look overly cluttered and too imposing on first inspection. Therefore, in the version presented here, the descriptive terms are removed.

7.3. Selection of flight tasks for exposing RPC in the simulator

Based on the results of the ARISTOTEL rigid body RPC test campaign, Table 5 provides an appraisal of the rotorcraft task suitability during the testing. It can be seen from this Table that the most suitable tasks for RPC detection correspond to the Precision Hover and Roll Step Manoeuvre. The Precision Hover (PH) in particular proved to be the task the most successfully triggered RPC events. This task will be discussed in the next paragraph. The results from the simulator test campaigns have been reported in [21,26].

The Precision Hover (PH) manoeuvre contained within ADS-33 is a multi-axis re-position stabilisation task to assess low-speed performance. The task assesses both the ability of the pilot to transition the aircraft from translating flight to hover, and the ability to maintain position precisely. Pilots are required to maintain a stabilized hover whilst keeping a pole reference position within the hover board from their point of view. The primary height and lateral cueing is given by a “hover board” (see Fig. 25).

**Table 5**  
HQR ratings for precision hover task in the SRS and HFR simulators.

Pilot	HFR Pole Location (ft)			SRS Pole Location (ft)		
	20	40	75	20	40	75
A	4, 5	4	3, 2	5 <sub>(3)</sub>	6	6
C	5	5 <sub>(2)</sub>	3	5 <sub>(2)</sub>		
D	7	5	3	7	6 <sub>(2)</sub>	5 <sub>(2)</sub>
E	4	5	4 <sub>(3)</sub>	7 <sub>(4)</sub>	7 <sub>(5)</sub>	6 <sub>(2)</sub>
						7 <sub>(2)</sub>
				-	-	-

ADS-33 recommends a distance of 150ft between aircraft and hover board. It is usual for the pole to be placed at 75 ft from the aircraft, midway between the hover board and the reference hover location. The reference pole was moved closer to the aircraft whilst keeping the task performance tolerances the same for the ARISTOTEL test campaign to try to obtain higher-gain pilot inputs. Three pole locations were used in the experiments: 75 ft (as in ADS-33), 40 ft, and 20 ft. The distance between the aircraft and the hover board was kept constant at 150 ft. Fig. 25 shows the pole as in ADS-33 at the central location (75 ft) and Fig. 26 at the modified 20 ft position.

The combination of time delays and rate limits were used together with pole location to produce different vehicle configurations for the investigation: CONF1 denoted the case when no triggers were added to the task (baseline case); CONF2 denoted the case where a time delay of 250ms was applied in the lateral cyclic stick; CONF 3 denoted the case where only rate limits were applied to both the longitudinal and lateral axis controls (longitudinal = 5 deg/s, lateral=2.5 deg/s); finally, CONF4 denotes the case where both time delays and rate limits were applied (longitudinal time delay= 180 ms and rate limit=5 deg/s, lateral time delay=250 ms and 2.5 deg/s).

Table 5 shows the handling qualities ratings (HQRs) using CONF1 (PIO robust). Results are shown for both sets of tests completed in HFR and SRS. Subscripts next to each numerical rating denote the number of times the rating was awarded. For the HFR results, predominantly Level 1 HQRs were awarded for the 75 ft pole location. However, in SRS, due to the poorer cueing environment and lack of ground references, the task resulted in predominantly Level 2 HQRs. The HQRs were not sensitive to pole location within SRS. However, in HFR, the position of the pole

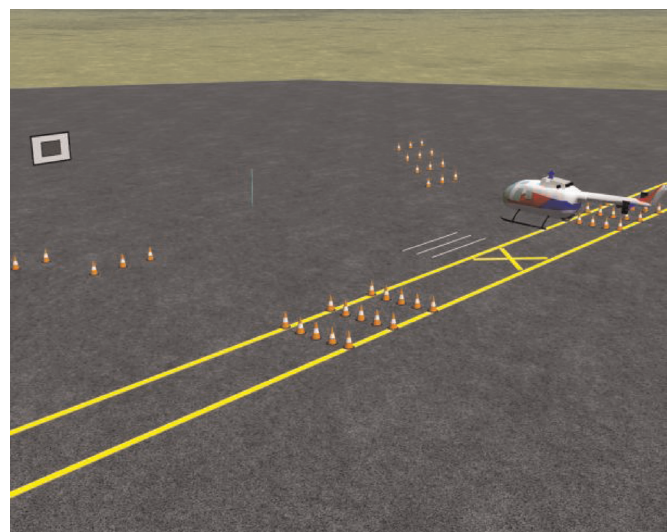

Fig. 25. : External view of standard ADS-33 Precision Hover course set-up.

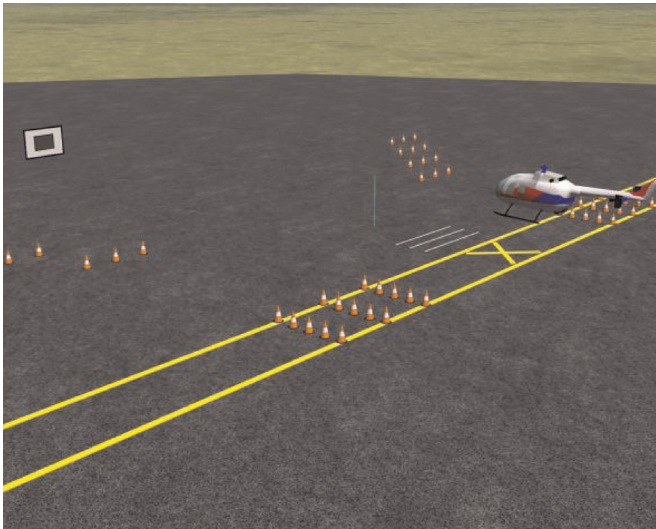

Fig. 26. : External view of modified Precision Hover course set-up.

location changed the ratings from predominantly Level 1 to Level 2 HQRs. This was due to the pilot difficulty in maintaining task performance in the initial phase of the manoeuvre.

Fig. 27 presents the APC ratings awarded during the completion of the PH manoeuvre for the four configurations and different pole location. For the pole position at 75 ft in CONF 1, HFR showed no RPC tendencies while RPC tendencies were found in SRS. On the contrary, in CONF 4, SRS showed no RPCs while HFR showed severe RPC oscillations. This contrary simulator behaviour is believed to be due to the limited visual cues in SRS (narrower horizontal visual angles and the absence of chin windows). This limitation resulted in poorer translational rate cueing in SRS with the pilots being less inclined or less able to correct for aircraft lateral and longitudinal drift. As a result, the pilots did not exert the expected level of tight closed-loop control and did not trigger an RPC in SRS. Furthermore, in both simulators, for the majority of the cases completed with CONF 2 and CONF 3 with the pole location at 75ft, no RPC tendencies were reported. In both simulators, one pilot was found to expose the most severe RPCs, as his approach to the manoeuvre was the most aggressive of the pilots used in the study.

Fig. 27 shows that, as the pole was moved from 75ft through 40ft to 20ft using vehicle configurations CONF1 to CONF4, as the

task performance tolerances were tightened, the pilot gain and workload increased in the lateral and heave axes in both simulators. Now RPCs were triggered in both simulators (although a difference in the susceptibility of each pilot, based on their strategy, was observed). For the pole at 20ft, the severity of RPC events experienced was the highest. Bringing the pole closer to the pilot increased the emphasis on the forward visual cue, and reduced the emphasis offered by the ground references. In this way, the mean ratings between simulators became more consistent.

It was observed that, although modification of the PH manoeuvre increased consistency between the predicted and experienced PIO tendencies, the task allowed for low-gain control activity during the stabilised hover. One pilot even employed an almost 'open loop' control strategy throughout the whole test campaign and was able to avoid any 'Severe PIOs' for all Precision Hover configurations. This pilot consistently backed out of the control loop prior to any oscillations developing and successfully managed to complete even the most demanding task within the specified performance requirements. To counteract this, it is suggested that further modifications might need to be implemented to the PH to force the pilot's gain to be high. One possible modification would be to replace the inner region of the hover board with a target. The pilot would then be required to keep closed-loop control by keeping the reference point in the 'absolute centre' of the hover board.

7.4. Phase Aggression Criterion (PAC) as a measure of A/RPC tendencies in simulator testing

Intuitively, control input, velocity and frequency can be used as measures of pilot workload, i.e. as measures of their activity. For example, the cut-off frequency parameter defined as the upper frequency for which 50% of the power of the control input signal is contained (70.7% of the root mean square of the control input) has been successfully used as a measure of pilot workload during completion of a mission task element [105-107]. Also, the control attack parameter, defined as the peak rate of change of the control deflection to the magnitude of the control deflection, has been successfully used to measure pilot activity in the time domain [20]. However, it is often recognised that it is almost impossible to design an A/RPC free vehicle [13]. Therefore, since the 1990s, a new philosophy has been introduced in A/RPC research analysis motivating to detect and correct potential tendencies for pilot-aircraft couplings not off-line but on-line in real flight time. New

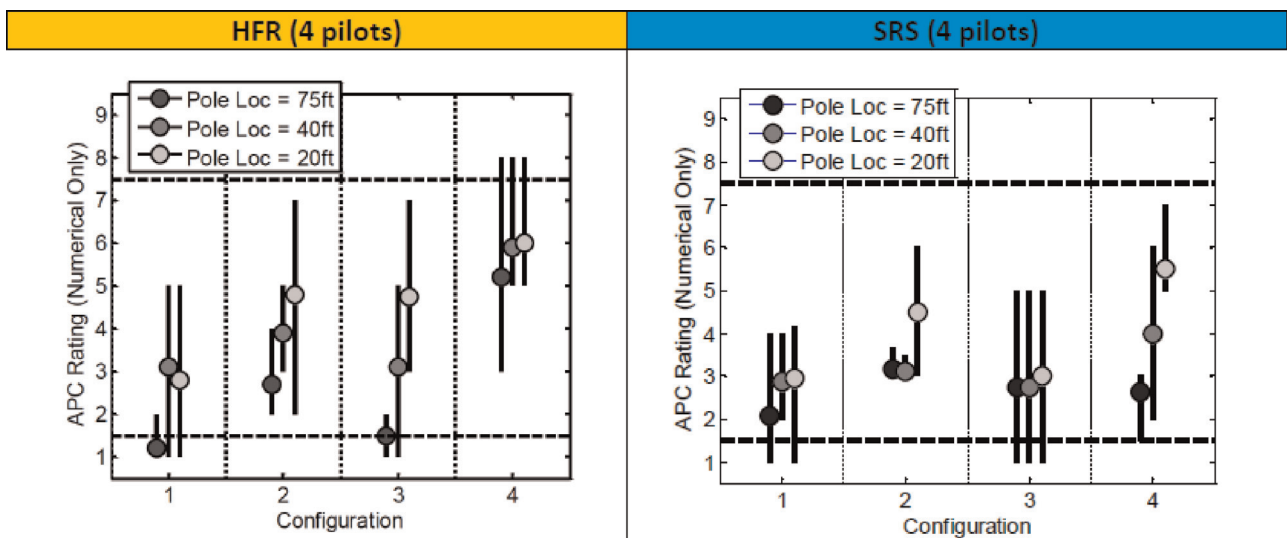

Fig. 27. APC ratings for the precision hover, SRS and HFR simulators.

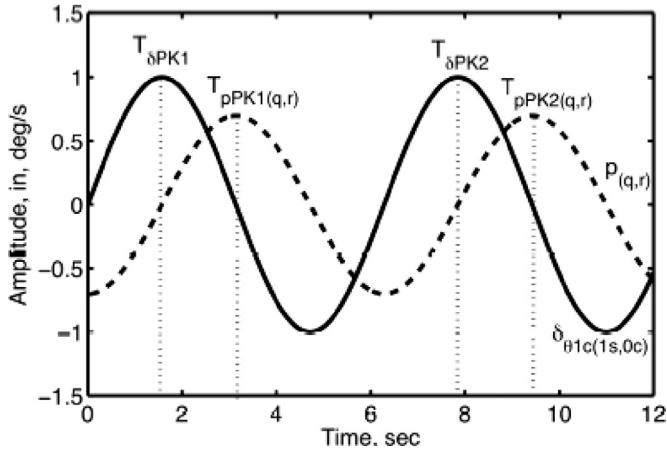

Fig. 28. Calculation of phase distortion in the time domain.

methods for on-line PIO detection have been developed for fixed-wing aircraft which have been designed to be implemented especially as a safety precaution during flight testing. This section will present the Real-time Phase Aggression Criterion (PAC) developed within the ARISTOTEL project for an objective evaluation of A/RPCs in the simulator.

PAC criterion is based on the “Real-Time Oscillation VERifier” (ROVER) on-line criterion which was developed by Mitchell [88] in the late 1990s. ROVER was developed as a real-time PIO identification method to warn the pilot that a PIO is in progress, so that preventive action can be taken. In simulator RPC testing, ROVER was used to provide an alternative means for engineers to verify pilots’ subjective ratings. More detail on ROVER can be found in Ref. [88], but the key points are summarised here for completeness. ROVER operates on two time-domain signals measured during flight, namely the vehicle angular rate and pilot control stick input. A score of 4 flags need to be given to the signals in order for an A/RPC to be considered detected. The flags are given as follows: a first flag is set every time a peak in vehicle body angular rate is detected and its oscillation frequency (computed as the time between the current and previous peaks) is in the range associated with A/RPC; a second flag is set if the peak-to-peak body angular rate amplitude is above the threshold for A/RPC; a third flag is set if the phase angle between the peaks in body angular rate and the peaks in control stick is in the range for A/RPC; a fourth and final flag is set if the peak-to-peak control input amplitude is above a predefined threshold value. A score of 4 flags corresponds to a detected A/RPC. Two consecutive scores of 3 result in a 3.5 score and an A/RPC warning. In ARISTOTEL, an extension of the original ROVER algorithm was made in [14] in the sense that it was proposed to couple the ROVER algorithm with a quasi-real time detection of degradation in handling qualities. The subjective element when applying ROVER lies in the fact that it uses pre-defined threshold values for the angular rate and also for the control input which must be set by the user. Therefore, the thresholds must be carefully chosen; incorrect thresholds will yield over/under prediction. The thresholds depend also on the order of the filter as well as the cut-off frequency [14].

The new “Real-time Phase Aggression Criterion” (PAC) method [21,30,33] is based upon ROVER and the Pilot-Inceptor Workload (PIW) method proposed by Gray [91,92]. PIW was developed to identify A/RPC susceptibility in Boundary Avoidance Tracking (BAT) tasks, i.e. tasks that approach a boundary described as a danger. Two time-domain based parameters are used for PIW to estimate pilot control activity, i.e. Duty Cycle (DC) and Aggression ( $A_G$ ). The combination of the two parameters can provide an insight into the pilot control strategy and workload [94]. The key

points of PAC are as follows:

- First, the pilot input and vehicle output signals during real-time or post-processing simulation (see Fig. 28) are used to calculate the phase distortion parameter,  $\Phi$ :

$$\Phi = 360 \left( \frac{T_{p(q,r)PK2} - T_{p(q,r)PK1}}{T_{\delta PK2} - T_{\delta PK1}} \right) \quad (2)$$

- Second, the time-varying aggression ( $A_G$ ) parameter is calculated as:

$$A_G = \frac{1}{T_{p(q,r)PK2} - T_{p(q,r)PK1}} \int_{T_{p(q,r)PK1}}^{T_{p(q,r)PK2}} H_s |\delta_{\theta 1c}(1s,0c)(t)| dt \quad (3)$$

For a rate command system, the units of  $A_G$  are given as  $\text{deg/s}^2$ .  $A_G$  is the integral of the control input rate  $\delta_{\theta 1c}(1s,0c)(t)$  (longitudinal cyclic, lateral cyclic or collective) over the sampling time period. The result is divided by the sampling time period (this is adaptive upon the control/response frequency as every time a phase difference is measured a new  $A_G$  is also computed) and multiplied by the control gearing term  $H_s$ . The definition of control gearing  $H_s$  is:

$$H_s = \frac{\Delta p(q,r)}{\Delta \delta_{\theta 1c}(1s,0c)} = \frac{\theta_{1c}(1s,0c)}{\Delta \delta_{\theta 1c}(1s,0c)} \frac{\Delta p(q,r)}{\theta_{1c}(1s,0c)} \quad (4)$$

and describes the vehicle angular rate (roll, pitch or yaw) with respect to the pilot control input. For all of the research conducted in ARISTOTEL,  $H_s$  has been approximated as a constant. Further development of the method could lead to a time-varying  $H_s$ , potentially making the method more precise.

- Third, a 2-dimensional  $\Phi$ - $A_G$  chart can then be produced. The key regions of this chart are shown in Fig. 29. Points where  $\Phi$  is low and  $A_G$  is high describe the situation where vehicle output is synchronous to pilot control. In this situation, the pilot is driving the aircraft response. When  $A_G$  is low, and  $\Phi$  is high, the situation shows excessive phase lag with little pilot control input. This situation could manifest itself as mild pitch bobbles or open-loop control activity. Neither of these would warrant significant concern. However, the combination of high  $A_G$  and  $\Phi$  is indicative of oscillations that are driven by the pilot. This is the situation where A/RPCs are most likely to occur, and mitigation techniques may be required. In this situation, it is likely that the pilot response is being driven by the resulting vehicle oscillations.

Using a number of piloted simulation test campaigns, detailed PAC results were generated and RPC occurrences were identified. It was then possible to isolate regions of the  $\Phi$ - $A_G$  chart that related to the occurrence and severity of the identified RPC events. One example, taken from the simulation campaigns of ARISTOTEL, is next used to illustrate the utility of the PAC chart and its associated boundaries in helping to unmask RPC in the simulator. The example is for the PH manoeuvre test points as described above (see Fig. 26, 45 ft). Fig. 30(a) shows an example of a longitudinal control time history for the PH manoeuvre, taken from a case where a PIO has been detected on the PAC chart. Fig. 30(b) shows the associated PAC chart. It contains the  $\Phi$  and  $A_G$  data points, computed from the time history of Fig. 30(a), plotted against the Moderate and Severe PIO boundaries established for rate command systems during the ARISTOTEL project. A dotted line is also shown at 90 degree phase difference which is the classical criterion that indicates the possible existence of a PIO. It can be seen that the computed data points exist within both the ‘Moderate PIO’ and ‘Severe PIO’ regions of the chart. The shaded regions of Fig. 30 (a) indicate the periods for which PAC has detected a PIO as being

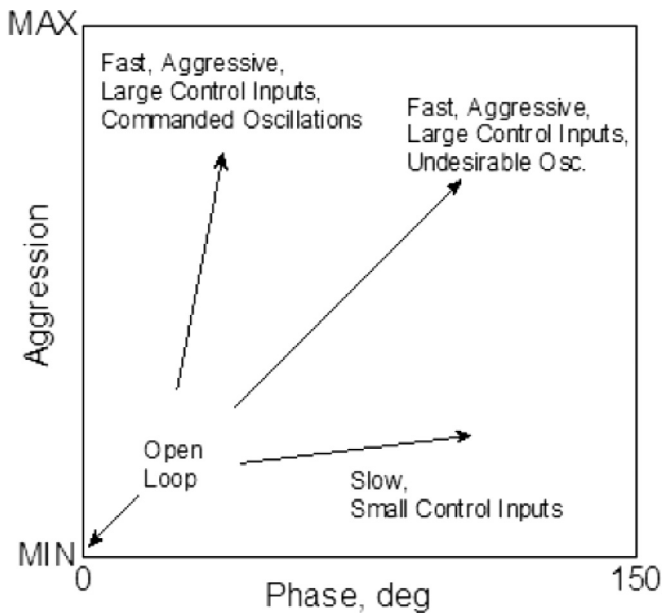

Fig. 29. Schematic of regions of the  $\Phi$  versus  $A_G$  chart [33].

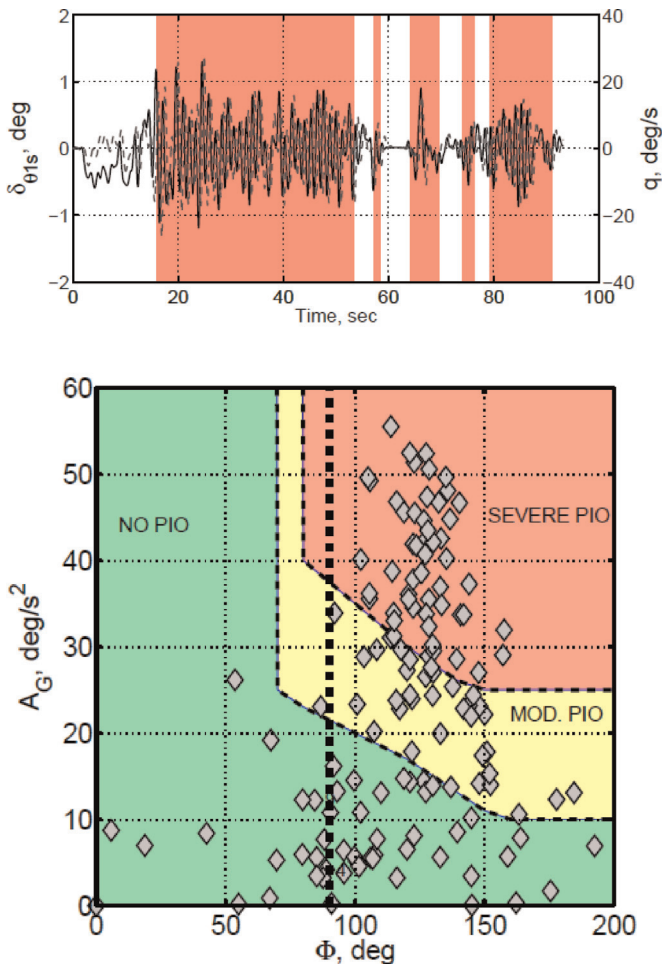

Fig. 30. Example of 'PIO' case - Longitudinal Axis - Pilot inputs and PAC Results.

present. As shown in the figure, the large oscillatory inputs within the trace are captured via the PAC boundaries, with the longest sustained period of observation between  $t=17$  s and  $t=55$  s.

Given that the computations can be performed in or near real

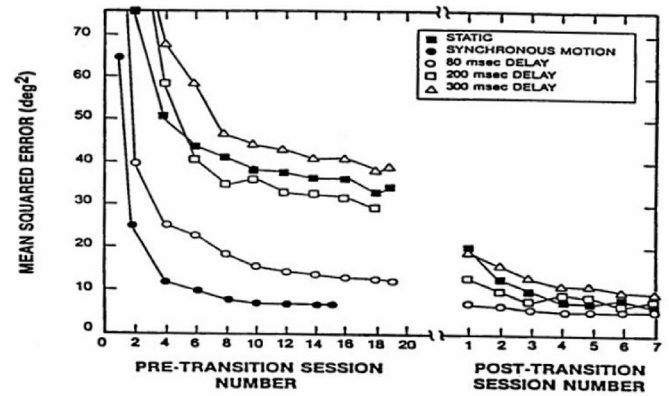

Fig. 31. Effects of Delay on Performance and Training [109].

time, it is conceivable that PAC-based PIO detection could be used for detecting RPC in the simulator or flight tests. This would be achieved by computing  $\Phi$  and  $A_G$  based upon measured real-time aircraft attitudes and inceptor positions/rates using extant on-board sensing. The PAC chart boundaries would be stored on the aircraft PIO detection/suppression system and, as the boundaries were approached, alerts issued and/or suppression systems activated. It is posited that an alert might be issued as the No/Moderate PIO boundary were crossed and preventative measures activated as the Moderate/Severe boundary were crossed. Of course, this would be subject to measures being taken to ensure that spurious or transient data points were dealt with appropriately.

### 8. Simulator latency characteristics

In current simulation standards, transport delay (simulator latency or simulator cue integration) is defined as "The total Synthetic Training Device (STD) system processing time required for an input signal from a primary pilot flight control until motion system, visual system or instrument response. It does not include the characteristic delay of the helicopter [vehicle] to be simulated." [65,66]. Ideally all cueing elements of a simulator (motion, visual and instruments) should respond to pilot inputs at the same rate as the real aircraft. However, there are many sources of delay<sup>7</sup> in simulators which will normally preclude such a response. Such sources are associated with:

- Control loading computation frames (typical 1 ms);
- Flight dynamics computation frames (typical 14 to 18 ms);
- Visual computation frames (typical of 20 ms);
- Instrument response (typical delay of 40 ms);
- Motion cueing algorithm delay (typical delay of 20 ms)

This results in time delays of the order of 100 ms introduced by computer power. The maximum allowable latency which can be accommodated will usually depend upon the nature of the simulated aircraft and on the tasks demanded of it. The (potentially large) time delays introduced into the vehicle by the flight control system (FCS) computer(s) especially in the case of flight by wire (FBW) FCS aircraft needs to be added to the simulator latency. It was shown that almost every aircraft and rotorcraft equipped with a partial or total FBW FCS has, at one time or another in the development process, experienced one or more A/RPC events [13,14]. This is especially true for helicopters which can have equivalent

<sup>7</sup> A distinction should be made between delay and lag in a system. Delay can be defined as the "dead time" between an event and a reaction to that event. Lag is the phase shift resulting from system's dynamics or system's delay.

time delays of the order of 200 milliseconds or more. This delay is not only due to FCS computer(s) but is also due to the stick dynamics (input filtering).

The available research regarding simulator latency and transport delay suggests that the simulator user needs to determine per system the best way to minimise transport delays and synchronise the motion and visual cues. A thorough system design is generally necessary in terms of: simulation objectives, task analysis, behavioural objectives, cue identification and cue implementation. A key resource available herein is the engineering data compendium of Boff and Lincoln [101]. Also, a good review on publications related to manual control with delays is given in Ref. [110].

For example, for the highest Level of simulator qualification [65,66], the total transport delay from control input to visual and motion response must be no more than 100 ms. Previous research [95,100,101] that investigated the effect of varying simulator transport delay on flight simulators showed that the total transport delay is dependant on both the visual system delay and the motion system delay. If the motion and visual system transport delays are not correctly synchronised, it is likely that the pilot will experience conflicting visual and vestibular cues. This leads to disorientation which can cause the pilot to feel sick and compromises learning benefits. Indeed, the results of Ref. [99] indicate that visual cues should be synchronous with the corresponding motion cues or, at worst, the visual cues should lead the motion cues. This is contradicted by EASA CS-FSTD (H) which contains the guideline "*Visual scene changes from steady state disturbance shall occur within the system dynamic response limit but not before the resultant motion onset*" [68].

Ref. [95] investigated the effect of varying simulator transport delay on HQs Ratings (HQRs). It showed that additional transport delays of only 80 ms resulted in degradation of the average HQRs from Level 1 to Level 2 for several tasks. This suggests that a simulator with an additional 80ms transport delay would result in a compromised training utility. It should be noted that the baseline transport delay in the simulator used for that study was only 10 ms. Lead compensation filters were used to eliminate the delays in the motion and visual systems [95]. Ref. [108] demonstrated that pilots are unable to ascertain the source of any perceived delay. The delays associated with the motion system were found to be more complex than those associated with the visual system due to the washout filters. It was suggested that the visual and motion delays should be matched rather than trying to reduce delays as much as possible in each system independently. It is generally known that delays have a negative effect on pilots' performance. Fig. 31 from Ref. [109] shows high pilot errors introduced by a 300 ms time delay. However, adaptation and learning from pilot training reduces the errors by 50%.

Regarding A/RPCs, as a general rule, the more aggressive the necessary manoeuvring, the shorter the time delay that can be tolerated by the pilot. Multimodal pilot identification performed in ARISTOTEL [102] to investigate pilot model adaptation to added time delays and varying task difficulty showed that adding time delay to the vehicle model primarily increased the amount of PVS phase delay, and also reduced the bandwidth. Another observation was the reduction of pilot gain with added time delay. The greater the bandwidth, the lower the equivalent time delay. Insufficient vehicle bandwidth affects the resulting cueing quality.

## 9. Conclusions

Ground simulation can be effectively used as an assessment tool for unwanted aircraft/rotorcraft pilot couplings phenomena.

In order to unmask such complex instabilities, the simulator constituent parts (motion system, visuals, mathematical model, control loading system) must be carefully adapted. The goal of the present paper was to review necessary practises that contribute to the prediction of A/RPCs using ground-based simulators. The following key conclusions can be drawn from it:

- **Piloting tasks:** Tasks must be selected that create high-gain pilot inputs. The tasks must have well defined and well justified performance parameters, to force consistent pilot control strategy. However, the tasks are expected to expose performance (limitations) beyond that expected for normal operation of the vehicle and so tasks that reflect normal operating parameters should be avoided. The suitability of tasks to unmask A/RPC can be assessed using Handling Qualities Ratings and/or PAC. For fixed-wing aircraft, the flight tasks recommended to unmask APCs were gust landing, tracking the "jumping" runway, and roll tracking. These tasks forced the pilots to make stepwise control inputs, and triggered high-frequency structural modes that could lead to aeroelastic APCs. For helicopters, ADS-33 manoeuvres were considered to be a suitable baseline for RPC investigations. However, such manoeuvres need to be modified to expose deficiencies for different pilots and ensure consistent performance. For example, for the ADS-33 precision hover, moving the reference pole closer to the pilot decreased inter-pilot variability. For the ADS-33 roll step, increasing the task speed and narrowing the gates showed a larger increase in RPC susceptibility in the simulator.
- **Motion cues:** motion cueing is essential for tasks which require high response to control unexpected disturbances of low stability vehicles. Motion requirements are task dependant and care should be taken to ensure that the available motion cueing is suitable for the task being conducted. Poor motion cueing can be worse than no motion cueing at all.
- **Visual cues:** these are the primary sense for the perception of real world. Visual cues are important in unmasking A/RPCs, however, a good integration of visual and motion cues is more important than treating them separately. Results presented in this paper demonstrated that using a simulator with reduced vertical visual cueing but with increased task difficulty and correct motion cueing was sufficient to trigger RPC instabilities.
- **Control inceptor type:** this is one of the most sensitive elements that contributes to A/RPC occurrences in the simulator. The paper demonstrated that varying the manipulator characteristics, i.e. using either a control yoke (wheel) system, a central stick or a side-stick affects the BDFI. The greatest pilot rating degradation was due to the biodynamic interaction between the pilot and the elastic accelerations corresponding to the central stick system.
- **Mathematical model:** this resides at the heart of the simulator. Although the vehicle system as a whole, including FCS, displays and actuators should be well reproduced in the simulator in order to reveal its proneness to A/RPCs, one can use also specific models depending on the particular problem to be studied and the flight configuration. Using an extensive model to investigate a specific phenomenon is not convenient because no physical insight can be obtained. Often, instead, building a case-specific model can be of help in order to understand the instability and the physics.

Regarding the question whether ground-based simulators can reveal the existence of adverse A/IRPCs, the paper demonstrated that selecting proper tasks could result in triggering A/RPCs in the simulator. A difference in the susceptibility of each pilot, based on their strategy, was observed in the ARISTOTEL project. Many challenges are waiting to be solved for future use of simulators for

unveiling A/RPCs. It is hoped that this paper may light the way for some simulator practises needed for unmasking adverse A/RPCs.

[FP7/2007–2013] under grant agreement n°ACPO-GA-2010-266073, project ARISTOTEL. Special acknowledgements to all other members actively involved in the ARISTOTEL project.

**Acknowledgements**

The research leading to this overview has received funding from the European Community's Seventh Framework Programme

**Appendix A1. Motion Fidelity rating scale**

See Fig A1.

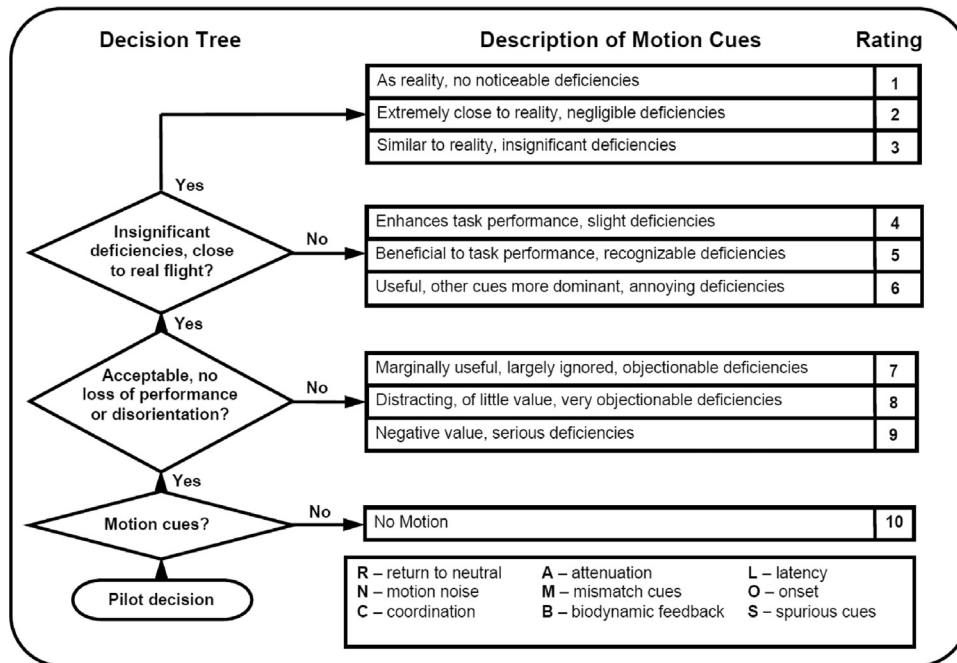
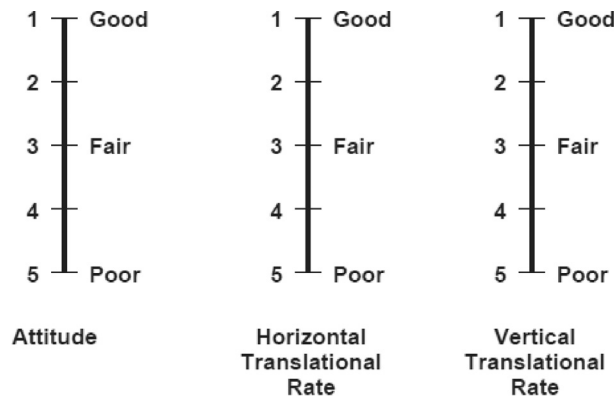

Fig. A1. Motion Fidelity rating scale [104].

**Appendix A2. Visual Cue Rating**

See Fig. A2.



Pitch, roll and yaw attitude, and lateral-longitudinal, and vertical translational rates shall be evaluated for stabilization effectiveness according to the following definitions:

- Good :** Can make aggressive and precise corrections with confidence and precision is good.
- Fair :** Can make limited corrections with confidence and precision is only fair.
- Poor:** Only small and gentle corrections are possible, and consistent precision is not attainable.

Fig. A2. Visual Cue Rating [57].

**Appendix A3. Simulation Fidelity Rating scale (SFR)**

See Fig. A3.

ADEQUACY OF FIDELITY FOR SELECTED TASK		COMPARATIVE TASK PERFORMANCE	PILOT'S TASK STRATEGY COMPARED TO AIR VEHICLE	FIDELITY RATING			
Is fidelity satisfactory for purpose?	YES	FIT FOR PURPOSE	Comparable performance attainable	and	Task strategy entirely representative of the simulated vehicle.	1	Level 1
				and	Task strategy largely representative of the simulated vehicle.	2	
				and	Minimal adaptation of task strategy required to perform task.	3	
Does fidelity compromise task execution?	NO	FIDELITY WARRANTS IMPROVEMENT	Representative performance attainable	and	Task strategy is not meaningfully representative of the simulated vehicle.	4	Level 2
				and	Considerable adaptation of task strategy required to perform task.	5	
				and	Extensive adaptation of task strategy required to perform task.	6	
Does fidelity allow task execution?	YES	FIDELITY REQUIRES IMPROVEMENT	Representative performance not attainable	or	Task strategy is not meaningfully representative of the simulated vehicle.	7	Level 3
				or	Considerable adaptation of task strategy required to perform task.	8	
				or	Extensive adaptation of task strategy required to perform task.	9	
PERFORM TASK		NOT FIT FOR PURPOSE	Representative performance not attainable	or	The task requires a strategy entirely inappropriate to the simulated vehicle.	10	Level 4

Fig. A3. Simulation Fidelity Rating scale SFR, Issue C [76].

Appendix A4. Traditional PIO rating scale (PIOR)

See Fig. A4.

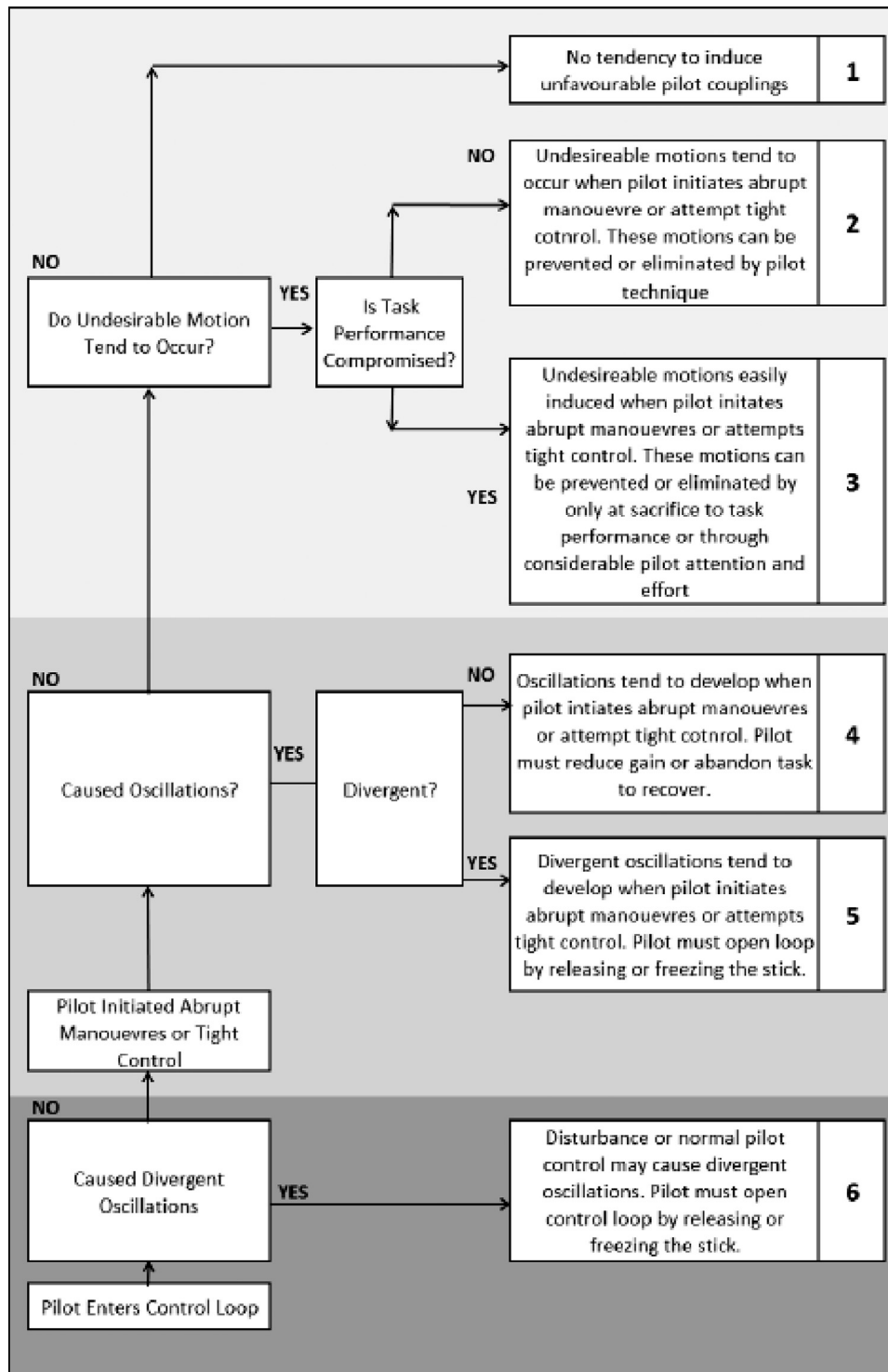

Fig. A4. Traditional PIO rating scale (PIOR) [87].

**Appendix A5. Adverse Pilot Coupling APC rating scale (APC)**

See Fig. A5.

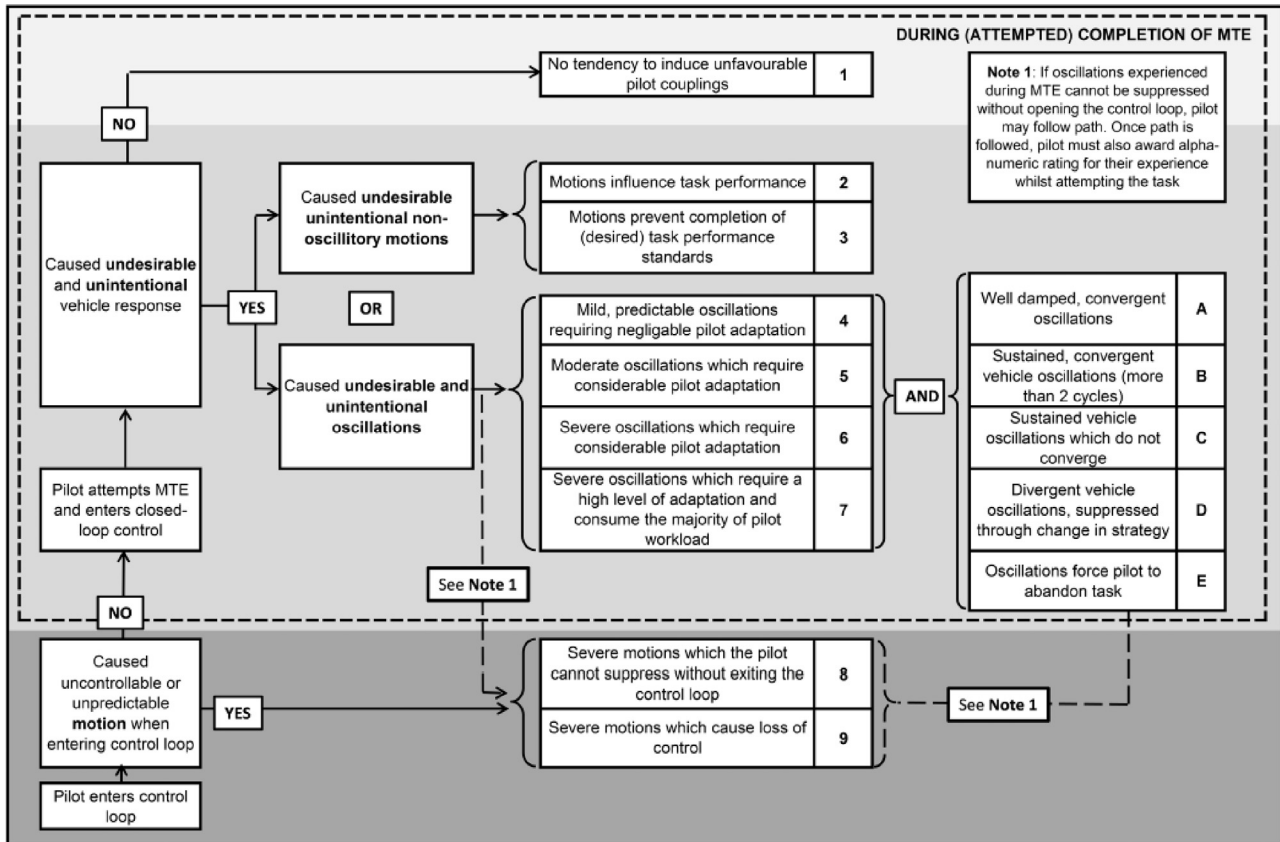

Fig. A5. The Adverse Pilot Coupling APC rating scale (APC) [33].

**References**

[1] Angelo, J.D. The Link Flight Trainer - A Historic Mechanical Engineering Landmark. In: ASME International, Roberson Museum and Science Center, New York, June 2000 (<http://files.asme.org/ASMEORG/Communities/History/Landmarks/5585.pdf>).

[2] Greenyer, F. A History of Simulation: Part II - Early Days. Military Simulation & Training, Issue 5, 2008.

[3] Civil Aviation Authority. Zero Flight Time Training. (<http://www.caa.co.uk/default.aspx?catid=1591&pageid=8465>).

[4] J. Burki-Cohen, T.H. Go, T. Longridge, Flight Simulator Fidelity Considerations for Total Air Line Pilot Training and Evaluation. In: AIAA Modelling and Simulation Technologies Conference, Montreal, Canada, Aug. 6-9, 2001. AIAA 2001-4425.

[5] P.A. Ray, Quality Flight Simulation: Why?. In: AIAA Flight Simulation Technologies Conference, San Diego, CA, July 29-31, 1996. AIAA 96-3488.

[6] M.A. Baarspul, Review of flight simulation techniques, Prog. Aerosp. Sci. 27 (1) (1990) 1-120.

[7] Z.C. Roza, Simulation Fidelity Theory and Practice, Delft University, 2005, Ph. D. dissertation.

[8] D. Liu, N.D. Macchiarella, D.A. Vincenzi, Simulation Fidelity, CRC Press (2008), p. 61-73, ch. 4.

[9] J. Allen, R.T. Hays, L.C. Buffardi, Maintenance training simulator fidelity and individual differences in transfer of training, Hum. Factors 28 (5) (1986) 497-509.

[10] A.T. Lee, Flight Simulation: Virtual Environments in Aviation, Ashgate Publishing Limited, 2005.

[11] B.L. Aponso, D.T. Tran, J.A. Schroeder, Rotorcraft Research at the NASA Vertical Motion Simulator. In: American Helicopter Society 64<sup>th</sup> Annual Forum, Montréal, Canada, April 29-May 1, 2008.

[12] D. Gross, D. Pace, S. Harmoon, W. Tucker, Why fidelity? In: Spring Simulation Interoperability Workshop, 1999.

[13] D.T. McRuer, et al., Aviation Safety and Pilot Control: Understanding and Preventing Unfavorable Pilot-Vehicle Interactions, ASEB National Research Council, National Academy Press, Washington D.C., 1997.

[14] M.D. Pavel, et al., Rotorcraft Pilot Couplings - Past, Present and Future Challenges, Prog. Aerosp. Sci. 62 (2013) 1-51, <http://dx.doi.org/10.1016/j.paerosci.2013.04.003>.

[15] M.D. Pavel, et al., Practices to identify and preclude adverse Aircraft-and-Rotorcraft-Pilot Couplings - A design perspective, Prog. Aerosp. Sci. 76 (2015) 1-35, <http://dx.doi.org/10.1016/j.paerosci.2015.05.002>.

[16] M.D. Pavel, et al. Present and Future Trends in Rotorcraft Pilot Couplings (RPCs) - A Retrospective Survey of Recent Research Activities within the European Project ARISTOTEL. In: 36th European Rotorcraft Forum, Gallarate, Italy, 13-14 September 2011.

[17] V. Muscarello, P. Masarati, G. Quaranta, Robust Aeroelastoc Analysis for the Investigation of Rotorcraft Pilot Couplings. In: CEAS Conference, Venice, Italy, 24-28 Oct. 2011.

[18] P. Masarati, G. Quaranta, M. Gennaretti, J. Serafini, An Investigation of Aeroelastic Rotorcraft-Pilot Interaction, In: 37<sup>th</sup> European Rotorcraft Forum, Gallarate, VA, Italy, Sept. 13-15, 2011.

[19] M.D. Pavel, et al. A Retrospective Survey of Adverse Rotorcraft Pilot Couplings in European Perspective. In: Proceedings of the AHS 68th Annual Forum and Technology Display, Fort Worth Texas, USA, 2012.

[20] M. Jones, M. Jump. Generic Research Simulator Requirements for Prediction of Adverse Rotorcraft Pilot Couplings in the Heave Axis. Fort Worth Texas. In: Proceedings of the 68th Annual Forum of the American Helicopter Society, 2012.

[21] M. Jones, M. Jump, L. Lu, D. Yilmaz, M.D. Pavel, Using the Phase-Aggression Criterion to Identify Rotorcraft Pilot Coupling Events. In: Proceedings of the 38th European Rotorcraft Forum, Amsterdam, the Netherlands, 4-7 Sept., 2012.

[22] J. Serafini, M. Molica Colella, M. Gennaretti, A Finite-State Aeroelastic Model for Rotorcraft Pilot Assisted Oscillations Analysis. In: Proceedings of the 38th European Rotorcraft Forum, Amsterdam, the Netherlands, 4-7 Sept., 2012.

[23] L. Lu, M. Jump, M. Jones, Tau Coupling Investigation Using Positive Wavelet Analysis. In: Proceedings of the 38th European Rotorcraft Forum,

- Amsterdam, The Netherlands, September 2012.
- [24] G. Quaranta, et. al. Evaluation of Rotary Wing Aeroelastic Stability Using Robust Analysis. In: Proceedings of the 38th European Rotorcraft Forum, Amsterdam, NL, Sept. 4-7, 2012.
- [25] M.D. Pavel, et. al. Adverse Rotorcraft-Pilot Couplings - Modelling and Prediction of Rigid Body RPC - Sketches from the Work of European Project ARISTOTEL. In: Proceedings of the 39th European Rotorcraft Forum, Moscow, Russia, 2013.
- [26] M. Jones, et. al. The Role of Flight Simulation in Exposing Rotorcraft Pilot Couplings. In: Proceedings of the 39th European Rotorcraft Forum, Moscow, Russia, 2013.
- [27] P. Masarati, et al. Biodynamic Pilot Modelling for Aeroelastic A/RPC. In: Proceedings of the 39th European Rotorcraft Forum, Moscow, Russia, 2013.
- [28] M. Gennaretti, et. al. Aeroelastic modelling. In: Proceedings of the 39th European Rotorcraft Forum, Moscow, Russia, 2013.
- [29] L. Zaichik, et al., *An Approach To Assess Aircraft - Pilot Coupling Caused By Structural Elasticity*, ERF, Moscow, 2013.
- [30] M. Jones, M. Jump. Prediction of Rotorcraft Pilot-Induced Oscillations Using the Phase-Aggression Criterion 2013 Phoenix Arizona. In: Proceedings of the 69th Annual Forum of the American Helicopter Society, 2013.
- [31] P. Masarati, G. Quaranta, M. Jump, Experimental and numerical helicopter pilot characterization for aeroelastic rotorcraft-pilot couplings analysis. Proc. Inst. Mech. Eng., Part G, J. Aerosp. Eng. 227 (1) (2013) 1-23, <http://dx.doi.org/10.1177/0954410011427662>.
- [32] L. Lu, et. al. Comparison of Simulator Platform and Flight Tasks on Adverse Rotorcraft Pilot Coupling Prediction, 70th Annual Forum of the American Helicopter Society, Montréal, Québec, Canada, May 20-22, 2014.
- [33] M. Johnes, M. Jump, Subjective and Objective Evaluation of PIO Tendencies. In: Proceedings of the 70th Annual Forum of the American Helicopter Society, Montreal, Canada. May 20-22, 2014.
- [34] Scannapenco, Laurent, et.al. HELISIM: From Engineering Simulation to Level D Training Simulation. In: Proceedings of the 60th Annual Forum of the American Helicopter Society, Baltimore, MD, June 7-10, 2004.
- [35] J. Hodgkinson, K.F. Rossitto, E.R. Kendall, The use and effectiveness of piloted simulation in transport aircraft research and development. In: Proceedings of the Flight Mechanics Panel Symposium, Brussels, Belgium, 14-17 Oct, 1991, AGARD-CP-513.
- [36] D.H. Klyde, et. al. A Flight Centered Approach to Assess Dynamic Flight Simulator Force Cueing Fidelity. In: Proceedings of the 49th AIAA Aerospace Sciences Meeting including the New Horizons Forum and Aerospace Exposition 4-7 January 2011, Orlando, Florida. AIAA 2011-921.
- [37] R.J. Heintzman, Determination of Force Cueing Requirements for Tactical Combat Flight Training Devices, ASC-TR-97-5001, 1996, Feb..
- [38] H.H. Bühlhoff, D. Berger, C. Terzibas, *From virtual images to actions, Virtual Images, Paris, France, 2006, In: Fifteenth Seminar.*
- [39] Anon. Literature for Flight Simulator (Motion) Requirements Research. FAA/Volpe Center Flight Simulator Human Factors Program, 2010, (<http://www.volpe.dot.gov/hf/pubs.html>).
- [40] B. Powers, *Space Shuttle Pilot-Induced-Oscillations Research Testing*, NASA TM-86034, 1984.
- [41] B.L. Aponso, B.L. Tran, J.A. Schroeder, S.D. Beard, Rotorcraft Research at the NASA Vertical Motion Simulator. AIAA Atmospheric Flight Mechanics Conference, Chicago, Illinois, Aug. 10<sup>th</sup>-13<sup>th</sup>, 2009.
- [42] E. KulbergE., P.O. Elgerona, SAAB Experience with PIO. AGARD AR-335.
- [43] D.G. Mitchell, D.H. Klyde, Recommended practices for exposing pilot-induced oscillations or tendencies in the development process 2004 AIAA 2004-6810. In: USAF Developmental Test and Evaluation Summit, Woodland Hills, California.
- [44] Kaplita, T.et. Al. Helicopter Simulation Development by Correlation with Frequency Sweep Flight Test Data. In: American Helicopter Society 45th Annual Forum, Boston, MA, May 1989.
- [45] Mitchell, D.G. Flight and Ground Testing for Pilot-Induced Oscillations. In: IEEE Aerospace Conference, Snowmass at Aspen, CO, USA, 6-13 March, 1999.
- [46] G.D. Padfield. Handling Qualities Engineering, Nikolsky Lecture of the 68th Annual Forum of the American Helicopter Society, Forth Worth Texas, 2012.
- [48] J.A. Schroeder. et al. Pilot-Induced Oscillation Prediction with Three Levels of Simulation Motion Displacement, AIAA 98-4333 Boston. In: AIAA Atmospheric Flight Mechanics Conference Proceedings, 1998.
- [49] J.A. Schroeder, W.W.Y. Chung, R.A. Hess, Evaluation of motion fidelity criterion with visual scene changes. J. Aircraft 37 (4) (2000) 580-587.
- [50] J.A. Schroeder, W.W.Y. Chung, Simulator platform motion effects on pilot-induced oscillation prediction, J Guid. Control. Dyn. 23 (3) (2000) 438-444.
- [51] J.A. Schroeder. Helicopter Flight Simulation Motion Platform Requirements, NASA/TP-1999-208766, 1999.
- [52] A.L. Celere, P.S. Varoto, C.D. Maciel. Verifying Pilot Gain in PIO Flight Test 2007 AIAA 2007-6640 Hilton Head, South Carolina. In: AIAA Atmospheric Flight Mechanics Conference and Exhibit, 20-23 August, 2007.
- [53] P.W. Caro, The relationship between flight simulator motion and training requirements, J. Hum. Factors Ergonom. 21 (4) (1979) 493-501, <http://dx.doi.org/10.1177/001872087902100411>, Aug.
- [54] J.C. Dusterberry, M.D. White, The Development and Use of Large Motion Simulator Systems in Aeronautical research and Development. In: 50 years of Flight Simulation, London, England, 23-25 April, 1979.
- [55] M. Sadoff, W.H. Charles, A critical review of piloted flight simulation research, Aerosp. Eng. 21 (9) (1962) 50-63.
- [56] D.G. Mitchell, R.H. Hoh, A. Atencio Jr., D. Key, The Use of Ground Based Simulation for Handling Qualities Research: A New Assessment, AGARD-CP-513, Brussels, Belgium, 1991. In: Flight Mechanics Panel Symposium.
- [57] Anon, Aeronautical Design Standard ADS33E-PRF, Performance Specification, Handling Qualities Requirements for Military R1otorcraft, US Army AMCOM, Redstone, Alabama, 2000, March 21.
- [58] D.L. Key, et al., Fidelity of simulation for pilot training, AGARD Advisory Rept. No. 159, North Atlantic Treaty Organization, 1980.
- [59] Hosman, R.J.A.W., van der Vaart, J.C. Motion cues: The influence on manual flight control. In: Flight Simulation of Helicopters, Status and Prospects, Int. Conf. Proc., The Royal Aeronautical Society, London, U.K., 1985.
- [60] R. Bussolaris, R.B. Sullivan, L.R. Young. Vestibular models for design and evaluation of flight simulator motion. In: Advances in Flight Simulation-Visual and Motion Systems, Int. Conf. Proc., The Royal Aeronautical Society London, U.K., 1986.
- [61] Bray, R.S. Visual and motion cueing in helicopter simulation. In: AGARD Conference Proceedings on 'Flight Simulation', paper no. 408, Cambridge, U. K., 1985.
- [62] L.D. Reid, M.A. Nahon, Response of Airline Pilots to Variations in Flight Simulator Motion Algorithms, J. of Aircraft 25 (7) (1988) 639-646.
- [63] Hodge, S., Perfect, P., Padfield, G.D.White, M. Optimising the Vestibular Cues Available from a Short Stroke Hexapod Motion Platform. In: American Helicopter Society 67th Annual Forum, Virginia Beach, VA, 2011.
- [64] J.B. Sinacori. The Determination of Some Requirements for a Helicopter Flight Research Simulation Facility, NASA-CR-152066.TR-1097-1, Sept, 1977.
- [65] Anon. JAR-STD 1A Aeroplane Flight Simulators. Joint Aviation Requirements Standard, 2000.
- [66] Anon. JAR-FSTD H, Helicopter Flight Simulation Training Devices, Joint Aviation Authority, 2008.
- [68] Anon, EASA CS-FSTD(H): Certification Specifications for Helicopter Flight Simulation Training Devices, European Aviation Safety Agency, 2012, June.
- [69] Anon, F.A.A. AC 120-40B Airplane Simulator Qualifications, Federal Aviation Administration Advisory Circular, 1991, July.
- [70] Anon, FAA AC 120-63 Helicopter Simulator Qualification, Federal Aviation Administration Advisory Circular, FAA AC, 1994.
- [71] Anon, Manual of Criteria for the Qualification of Flight Simulation Devices, Volume I - Aeroplanes, International Civil Aviation Organization, ICAO 9625, 2009.
- [72] Anon, Manual of Criteria for the Qualification of Flight Simulation Devices, Volume II - Helicopters, International Civil Aviation Organization, ICAO 9625, 2012.
- [73] R.K. Heffley, et al., Determination of motion and Visual System Requirements for Flight Training Simulators, Systems Technology Inc., U.S. Army Research Institute for the Behavioral and Social Sciences, Fort Rucker, 1981, Ala. Technical Report No. 546, August.
- [74] Zaichik, L.E., Yashin, Y.P. and Birukov, V.V. Peculiarities of Motion Cues Perception Against G-load. In: 4th European Conference for Aerospace Science, Saint Petersburg, Russia, 2011.
- [75] Spooner, A.M. Visual Simulation- Past, Present and Future. 50 Years of Flight Simulation conference. London, 23-25 April 1979.
- [76] Gareth, D. Padfield, *Helicopter Flight Dynamics, Second Edition*, Blackwell Science LTD., 2007.
- [77] E. Timson, *Flight Simulation Fidelity for Rotorcraft Design, Certification and Pilot Training*, University of Liverpool, 2013, Ph.D. Doctoral Thesis.
- [78] Reardon, S.E., Beard, S.D., and Aponso, B.L. Effects of Motion Filter Parameters on Simulation Fidelity Ratings. In: 70th Annual Forum of the American Helicopter Society, Montreal, Canada May 20-22, 2014.
- [79] Wiskemann, C.M., et. al. Subjective and Objective Metrics for the Evaluation of Motion Cueing Fidelity for a Roll-Lateral Reposition Maneuver. In: 70th Annual Forum of the American Helicopter Society, Montreal, Canada May 20-22, 2014.
- [80] M.D. Pavel, et al., Validation of mathematical models for helicopter flight simulators past, present and future challenges, Aeronaut. J. 117 (1190) (2013) 343-388.
- [81] G.E. Cooper, R.P. Harper, The use of Pilot Rating in the Evaluation of Aircraft Handling Qualities, NASA TN D-5153, 1969, April.
- [82] D.E. Johnston, D.T. McRuer, Investigation of Limb-Sidestick Dynamic Interaction with Roll Control, AIAA 85-1853, Snowmass, CO, 1985, In: Guidance, Navigation and Control Conference.
- [83] B.L. Aponso, D.E. Johnston, Effect of manipulator and feel system characteristics on pilot performance in roll tracking, Atmospheric Flight Mechanics Conference, AIAA 88-4326 Minneapolis, MN; United States, Aug. 15-17, 1988.
- [85] DiFranco, D.A. Flight Investigation of Longitudinal Short Period Frequency Requirements and PIO Tendencies. Technical Report, AFFDL-TR-66-163, Cornell Aeronautical Lab, 1967.
- [86] N. Weingarten, C. Chalk, *In-flight Investigation of Large Airplane Flying Qualities for Approach and Landing*, CALSPAN, Buffalo, New York, 1981, AFWAL-TR-81-3118.
- [87] McPherson, T.M., Hogan Jr., E.J. Low Altitude High Speed Evaluation of the F4A/B Airplane, Technical Report, ANTC-RAD32-103, 1963.
- [88] D.G. Mitchell D.H. Klyde. Identifying a PIO Signature - New Techniques Applied to an Old Problem, In: AIAA Atmospheric Flight Mechanics Conference, AIAA 2006-6495 Keystone, Colorado, 2006.
- [89] T.J. Parham D. Popelka D.G. Miller. Frobel A.T.V-22 pilot-in-the-loop aero-elastic stability analysis, In: Proceedings of the American Helicopter Society 47th annual forum, Phoenix AZ, 1991.
- [90] Walden R. Barry. A retrospective survey of pilot-structural coupling

- instabilities in naval rotorcraft. In: Proceedings of the 63<sup>rd</sup> Annual forum of the American Helicopter Society, Virginia Beach, VA; May 1–3, 2007.
- [91] W.R. Gray III, *Boundary Avoidance Tracking: A new pilot tracking model*, AIAA 2005-5810, San Francisco, 2005. In: AIAA Atmospheric Flight Mechanics Conference and Exhibit.
- [92] Gray III, W.R. A Boundary Avoidance Tracking Flight Test Technique for Performance and Workload Assessment. In: 38<sup>th</sup> Symposium of Society of Experimental Test Pilots, San Diego, 2007.
- [94] W.R. Gray III, *Handling Qualities Evaluation at the USAF Test Pilot School*, AIAA 2009-6317, Chicago, Illinois, 2009. In: AIAA Atmospheric Flight Mechanics Conference, Aug 10–13.
- [95] D.G. Mitchell, R.H. Hoh, A. Atencio Jr., D.L. Key, *Ground Based Simulation Evaluation of the Effects of Time Delays and Motion on Rotorcraft Handling Qualities*, US Army AD-A256 (1992), p. 921.
- [98] R.J. Telban, F.M. Cardullo, *Motion cueing algorithm development: Human-centered linear and nonlinear approaches*, NASA/CR-2005-213747, 2005NASA/CR-2005-213747, 2005.
- [99] W.W.Y. Chung, J.A. Schroeder, W.W. Johnson, *Effects of Vehicle Bandwidth and Visual Spatial-Frequency on Simulation Cueing Synchronization Requirements*, AIAA 97-3655 New Orleans, LA. In: AIAA Atmospheric Flight Mechanics Conference, 1997.
- [100] L. Guo, F.M. Cardullo, J. Houck, L. Kelly, T. Wolters, *Compensation Algorithms for Flight Simulators*, Calif. AIAA 2005-5896 San Francisco. In: AIAA Modeling and Simulation Technologies Conference and Exhibit, 2005.
- [101] R. Kenneth, Janet Boff, E. Lincoln. *Users Guide Engineering Data Compendium Human Perception and Performance*, Harry G Armstrong Aerospace, 1988.
- [102] D. Yilmaz, M.D. Pavel, *Identification of Pilot Control Behaviour during Rotorcraft-Pilot-Couplings*. In: 38th European Rotorcraft Forum, Amsterdam, The Netherlands, 2012.
- [104] Hodge, S., Perfect, P.; Padfield, G., White, M. *Optimising the Vestibular Cues Available from a Short Stroke Hexapod Motion Platform*. In: 67th American Helicopter Society Annual Forum, Virginia Beach, VA, 2011.
- [105] A. Antencio Jr., *Fidelity Assessment of a UH-60A Simulation on the NASA Ames Vertical Motion Simulator*, NASA TM-104016, 1993.
- [106] C.L. Blanken, H.J. Pausder, *Investigation of the effects of bandwidth and time delay on helicopter roll axis handling qualities*, J. Am. Helicopter Soc. 39 (3) (1994) 24–33.
- [107] J.A., Lusardi, C.L., Blanken, M.B. Tischer, *Piloted Evaluation of a UH-60 Mixer Equivalent Turbulence Simulation Model*. In: 49th American Helicopter Society Forum, St. Louis, Missouri, 1993.
- [108] D. Key, *Bandwidth and Simduce as a Simulator Fidelity Criteria*. In: NASA/FAA Helicopter Simulator Workshop, pp 147–160, 93N30690, 1992.
- [109] W.H. Levison, R.E. Lancraft, and A.M. Junker, *Effects of simulator delays on performance and learning in a roll-axis tracking task*, In: 15th Ann. Conf. on Manual Control, Dayton, OH., 1979, AFFDL-TR-79-3134.
- [110] G.L. Ricard, *Manual control with delays: a bibliography*, Comput. Graph. 28 (2) (1994) 149–154.
- [111] M.B. Tischler. *Digital Control of Highly Augmented Combat Rotorcraft*, NASA TM-88346. May 1987.
- [112] Valerie J. Gawron, Thomas W. Dennison, Michael Biferno, A. Mock-ups, Models, Simulations, and Embedded Testing, in: Samuel G. Charlton, Thomas G. O'Brien (Eds.), *Handbook of Human Factors Testing and Evaluation*, 2<sup>nd</sup> edition, Lawrence Erlbaum Associates, 2008.
- [113] J.A. Lusardi, et al. *In Flight Evaluation of Active Inceptor Force-Feel Characteristics and Handling Qualities*, American Helicopter Society 68th Annual Forum Fort Worth TX, 2012.
- [114] D. Allerton, *Principles of Flight Simulation*, John Wiley & Sons Inc., 2009.
- [116] William F. Moroney, Brian, W. Moroney, *Flight Simulators*, in: John W. Wise, V. David Hopkin, Daniel G. Garland (Eds.), *Handbook of Aviation Human Factors*, 2<sup>nd</sup> edition, Taylor and Francis Group, 2009.
- [117] S.H. Koekebakker, *Model Based Control of a Flight Simulator Motion System*, Delft University of Technology, 2001, Ph.D. thesis.
- [118] Victor V. Rodchenko, et. al. *Investigation of Feel System And Control Sensitivity Characteristics Influencing PIO of Unmaneuverable Aircraft*. TsAGI report in WL-TR-96-3109, 1996.
- [120] Sergey Boris et. al., *In-Flight Simulation of Large Aircraft Pilot Induced Oscillation Tendency And Its Criteria Development*. Gromov Flight Research Institute report in WL-TR-96-3109, 1996.



**NLR**

Anthony Fokkerweg 2

1059 CM Amsterdam, The Netherlands

p) +31 88 511 3113 f) +31 88 511 3210

e) [info@nlr.nl](mailto:info@nlr.nl) i) [www.nlr.nl](http://www.nlr.nl)