



NLR-TP-2000-267

GSP

A generic object-oriented gas turbine simulation environment

W.P.J. Visser and M.J. Broomhead



NLR-TP-2000-267

GSP
**A generic object-oriented gas turbine
simulation environment**

W.P.J. Visser and M.J. Broomhead

This report is based on a presentation held at the ASME Turbo Expo 2000, Munich, Germany, 8-11 May 2000.

The contents of this report may be cited on condition that full credit is given to NLR and the authors.

Division: Flight
Issued: July 2000
Classification of title: unclassified



Contents

ABSTRACT	3
INTRODUCTION	4
MODEL DESCRIPTION	5
Architecture	5
Object orientation	5
User interface	7
Component models	8
Custom component models	9
Thermo-chemical gas properties model	9
APPLICATION EXAMPLES	9
High-bypass turbofan engine	10
Recuperated turboshaft engine	12
Lift-fan driven by afterburning turbofan engine	14
Other applications	18
CONCLUSIONS	19
REFERENCES	19



ABSTRACT

NLR's primary tool for gas turbine engine performance analysis is the 'Gas turbine Simulation Program' (GSP), a component based modelling environment. GSP's flexible object-oriented architecture allows steady-state and transient simulation of any gas turbine configuration using a user-friendly drag & drop interface with on-line help running under Windows95/98/NT.

GSP¹ has been used for a variety of applications such as various types of off-design performance analysis, emission calculations, control system design and diagnostics of both aircraft and industrial gas turbines. More advanced applications include analysis of recuperated turboshaft engine performance, lift-fan STOVL propulsion systems, control logic validation and analysis of thermal load calculation for hot section life consumption modelling.

In this paper the GSP modelling system and object-oriented architecture is described. Examples of applications for both aircraft and industrial gas turbine performance analysis are presented.

¹ A demo copy of GSP can be downloaded from <http://www.nlr.nl/public/facilities/f141-01/index.html>

INTRODUCTION

NLR's 'Gas turbine Simulation Program' (GSP) is a component-based modelling environment for gas turbines. Both steady-state and transient simulation of any kind of gas turbine configuration can be performed by establishing a specific arrangement of engine component models in a model window as displayed in Figure 1.

GSP is a powerful tool for analysis of effects of ambient and flight conditions, installation losses, deterioration and malfunctions of control- and other subsystems on performance.

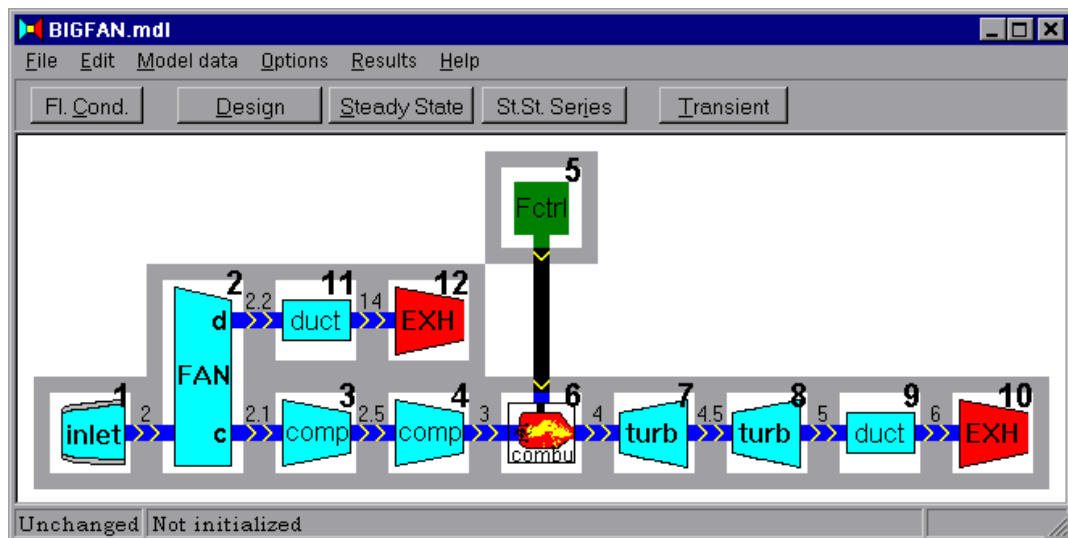

Figure 1: GSP model window with simple turbofan model

Since NLR is presented with a wide variety of gas turbine performance problems, simulation tools with a high degree of flexibility are required. Thus, GSP was developed to allow rapid adaptation to various problems rather than being dedicated to a specific task. MS-Windows² was selected as platform in view of the rapid increase in cheap available computer power, combined with the wide scale use of this operating system. GSP is implemented in the Borland® Delphi™ object-oriented environment³, offering excellent means to maintain and extend the program.

GSP has a user-friendly graphical drag & drop interface with on-line help allowing quick implementation of new engine models and rapid analysis of a wide variety of problems. The 'Application Examples' section shows GSP output examples.

During continuous development, GSP has been extended and improved with new features for specific applications. GSP version 8 includes a chemical gas model and generic multi-reactor 1-D combustor model (see 'Thermo-chemical gas properties model' section). A new biomass gasifier component has been developed for performance analysis of integrated gas turbine-biomass gasifier systems.

² Copyright © Microsoft Corporation

³ Copyright © Inprise Corporation



MODEL DESCRIPTION

GSP calculates gas turbine performance, relative to a reference operating point, usually the design point. Apart from design point analysis, GSP is particularly suitable for off-design analysis. Off-design steady-state and transient performance is calculated using the customary numerical methods of defining engine system states and solving the equations for the conservation of mass, energy and momentum (Visser, 1995).

A GSP gas turbine model consists of a user-specified arrangement of components in a model window (see Figure 1) corresponding to the particular gas turbine configuration. The model window includes all features necessary for the engine system simulation. The component icons in the model window may represent any sub-system model (thereby providing GSP's flexibility). Each component model requires user specification of data such as design point data values and component maps using its own specific interface.

Architecture

GSP's power in terms of flexibility and user-friendly interface is owed to its object-oriented architecture, designed with primarily these two qualities in mind. The flexibility is to a large extent reflected in the component modelling approach. The GSP component class hierarchy is given in Figure 2. With efficient ways to develop or adapt component models, simulations of new gas turbine configurations with different degrees of detail and fidelity can easily be realised.

For this approach, a generic solver was developed that is able to automatically solve and integrate the equations for any gas turbine configuration. The solver is implemented in the *engine system model* (Figure 3) and calculates steady-state or transient operating points for any valid configuration of components. The system model also includes code for simulating items and processes in the gas turbine which are not related to single components such as the ambient/flight conditions, shafts transmitting torque or power between components, secondary air flows such as cooling flows or compressor bleeds and transfer functions which simulate the behaviour of sensors, control system functions etc.

Object orientation

The engine system model solver must be able to handle a 'virtual' set of 'abstract components' with an undefined number of states. Different components will have different methods to add states and equations to the modelling system, depending on their specific characteristics.

Object-orientation offers an excellent mechanism for this problem. Many publications on object-oriented software design (Booch, 1991) show the three basic principles of object-orientation: *encapsulation*, *inheritance* and *polymorphism*. These principles offer significant potential to efficient gas turbine simulation software development.

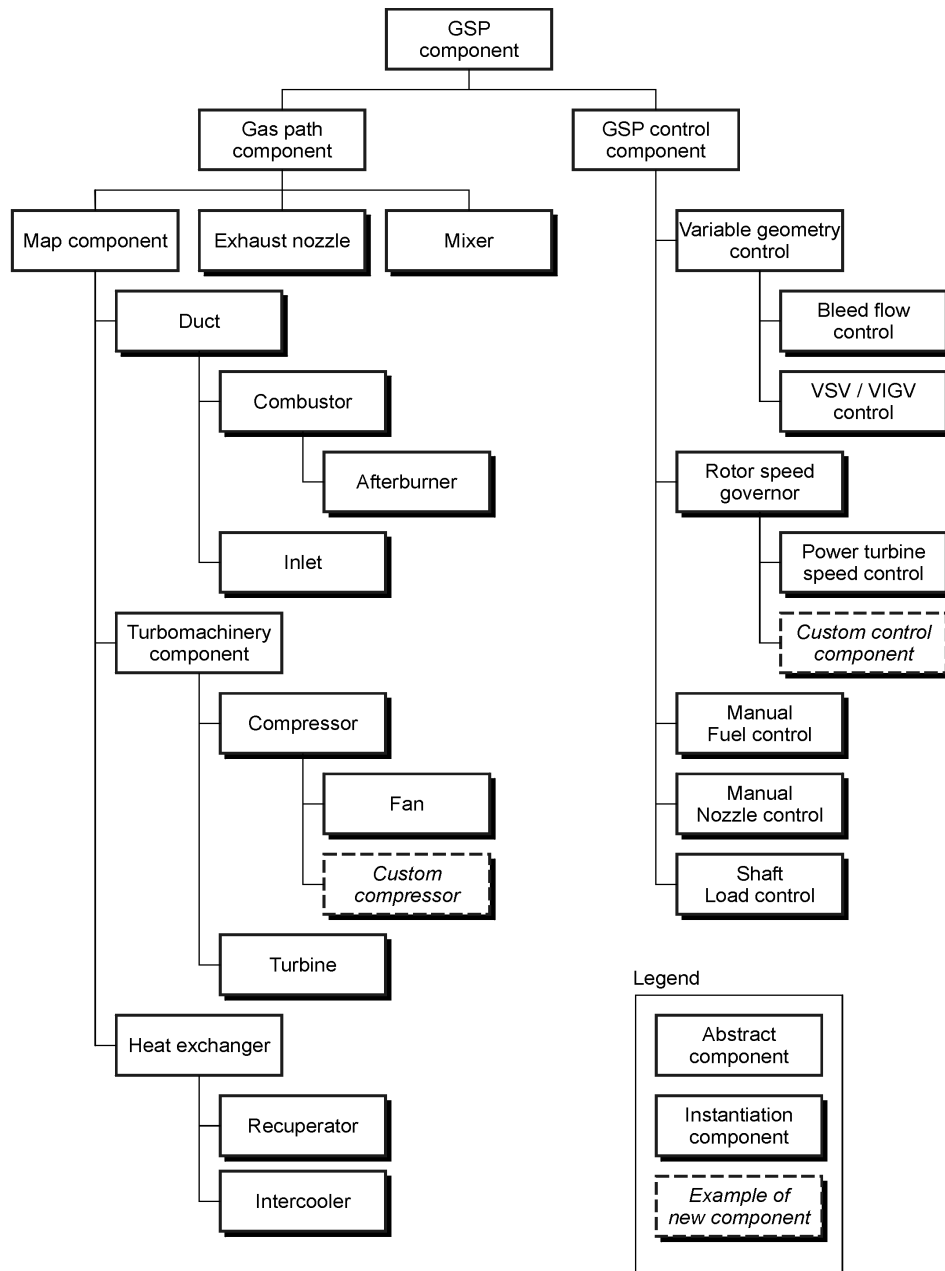

Figure 2 : Component inheritance architecture

Encapsulation enhances code maintainability and readability by concentrating all data declarations and procedures (both for interface and simulation calculations) in a single code unit.

Inheritance is used to concentrate code common to multiple component types in *abstract* component classes, preventing code duplication and enhancing code maintainability. For example, the abstract ‘Turbomachinery component class’ in Figure 2 represents an *abstract* ancestor incorporating all functionality common to compressors, fans and turbines.

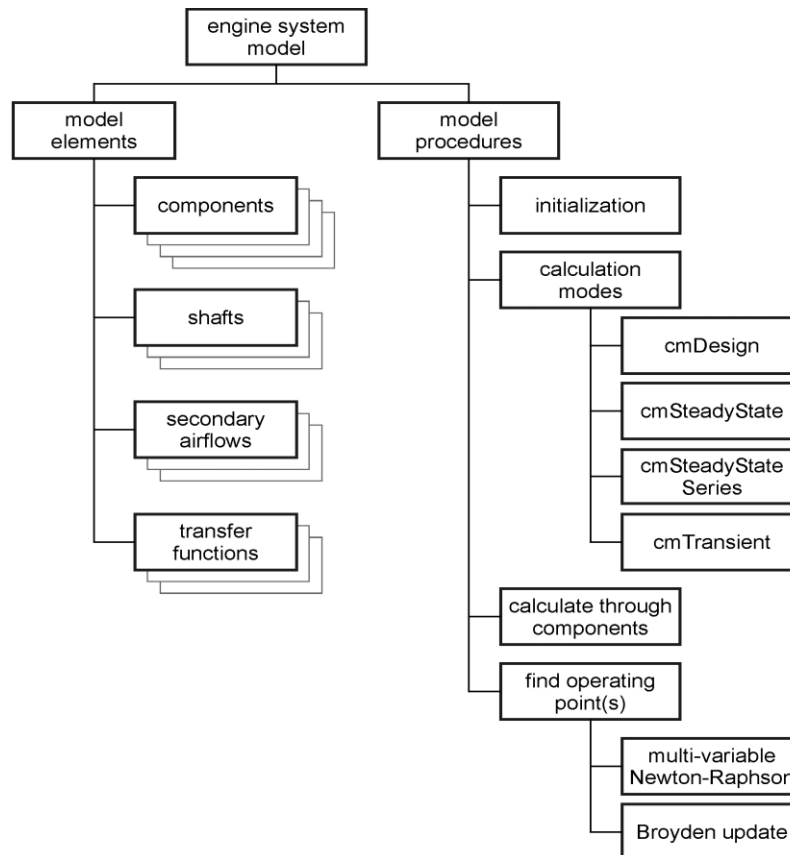

Figure 3 : Engine system model architecture

Polymorphism is the ability of parameters to represent different object classes and is extensively applied in GSP. For example, the system model code has an abstract (*polymorph*) identifier able to represent any component in the model. During simulation, the abstract identifier subsequently represents all components and runs their simulation codes.

User interface

GSP's graphical user interface fully reflects the object-oriented architecture for the gas turbine system and component models as is depicted in Figure 4. The main window mainly manages the model and library windows. A model window forms the 'work bench' on which a number of component icons are arranged to form a valid gas turbine configuration. It further includes all items necessary for a system simulation. GSP's extensive on-line help enhances user-friendliness.

Icons representing the component models are copied from component library windows onto the model window. The drag & drop interface allows the copying of multiple instances of components between models, enabling the user to build his own specific component repositories and save them as a generic model.

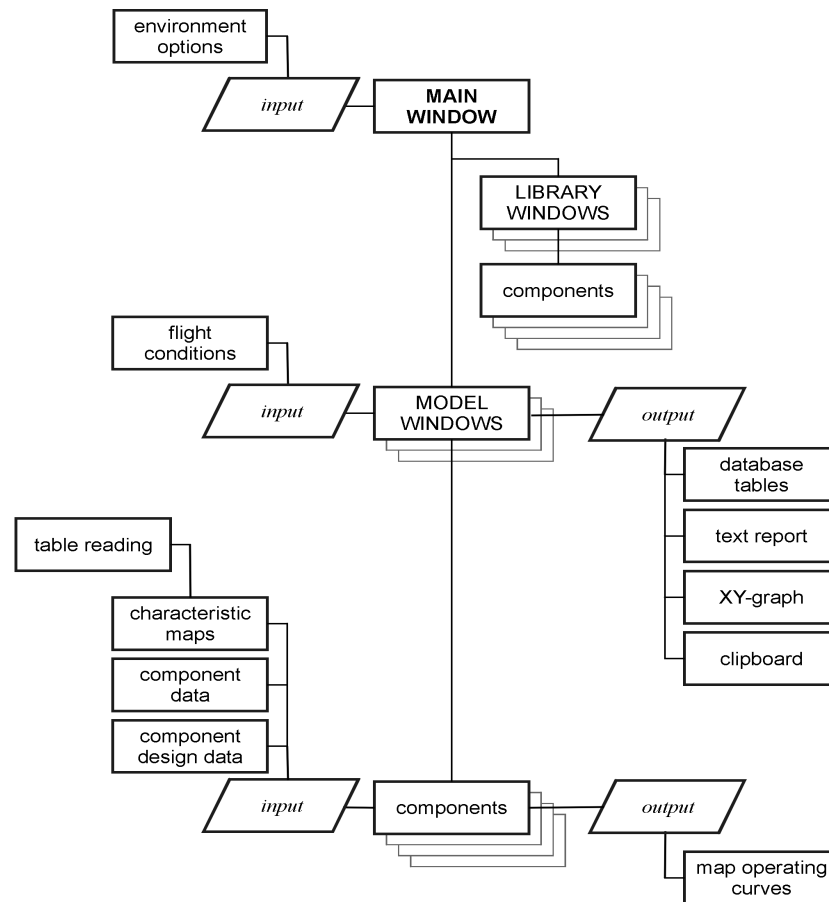

Figure 4 : Interface architecture

GSP offers a variety of flexible tabular and graphical input and output formats. For the model window these include ambient/flight conditions, a variety of simulation control options, result tables, result graphs, data export formats etc. Each component type has its own specific interface with design data, control system inputs, graphical component maps with operating curves, deterioration and variable geometry data etc. Off-design input includes tabular time functions for transient response calculations.

Component models

For most simulations the GSP standard component libraries are sufficient, which include 16 components such as an inlet, compressor, turbine etc. and several controls ranging from 'manual' controls, allowing the user to directly specify fuel flow or nozzle area, to components with PID (Proportional Integral Differential) control logic and customary fuel flow/burner pressure maximum accel and decel schedules. The standard components are shown in Figure 2.

All component models are non-dimensional (processes inside components are not described along a spatial parameter), except for the combustor model in case the multi-reactor option is used. The multi-reactor model includes the calculation of 1-dimensional combustion kinetics and requires detailed geometrical combustor data (Visser, Kluiters, 1999).



The gas path component models include volume dynamics and heat soakage effects. Component models employing tabular maps (such as compressors and turbines) include deterioration, variable geometry and Reynolds effects. For the turbine, there is a blade cooling flow model.

Compressor and turbine map table format is compatible with the GasTurb (Kurzke, 1995) map format. This allows the use of the SmoothC/SmoothT program (Kurzke, 1996) for editing and smoothing maps.

Custom component models

When detailed analysis into specific phenomena inside a gas turbine is required or for analysing the effects of engine control logic (e.g. non-linear, multivariable control, specific Full Authority Digital Electronic Control FADEC), specially tailored custom component models are required. Custom components are provided in separate custom libraries and require additional coding. With limited understanding of GSP's architecture, custom components can easily be derived from the standard component models using object inheritance (see the 'Architecture' section). Many custom components have been developed and applied such as for example in the 'Lift-fan driven by afterburning turbofan engine' example (page 14).

Thermo-chemical gas properties model

With GSP version 8, a new comprehensive gas model was implemented, based on the NASA CEA model (McBride and Gordon, 1994-1996), along with the detailed GSP multi-reactor combustor model component (Visser and Kluiters, 1999). Combined with a detailed specification of fuel composition, it provides a means to calculate effects of fuel and gas composition and water or steam injection on gas turbine performance and emissions, including dissociation effects. The gas model is used throughout the entire engine cycle calculation and currently includes accounting of the following species: CO₂, CO, O₂, Ar, H₂O(gas), H₂O(liquid), H₂, CH₄, C₂H₆, C₂H₄, C₃H₈, C₄H₁₀, O, H, OH, NO, N₂O, N₂. Chemical equilibrium is calculated for the CO₂-CO-O₂-H₂O-H₂ system. For water, also the vapor-liquid equilibrium is calculated. In the combustor model, a more detailed gas model is used, calculating equilibrium for CO₂, CO, O₂, O, H₂O, H₂, H, OH, NO, N₂O, N₂.

For GSP an efficient algorithm was developed to calculate the equilibrium using the equilibrium constants method (Kuo, 1986 and Glassman, 1996) thereby avoiding explicit solution of the Gibb's equations as done in the NASA CEA program.

APPLICATION EXAMPLES

GSP's potential is demonstrated using results from a number of applications, ranging from simple to complex:

1. High bypass turbofan engine off-design performance, a simple example of using GSP,

2. Recuperated turbohaft engine, a complex control problem,
3. Afterburning turbofan driving a lift-fan, a complex component modelling and control system design problem,
4. Other applications.

Note that some of these examples may be rehearsed using the free demo version (see footnote on page 3).

High-bypass turbofan engine

A relatively simple example of using GSP is the analysis of off-design performance of a typical high-bypass turbofan engine. The GSP demo model 'BIGFAN' is depicted in Figure 5. Generic component maps are used, scaled to the BIGFAN design point.

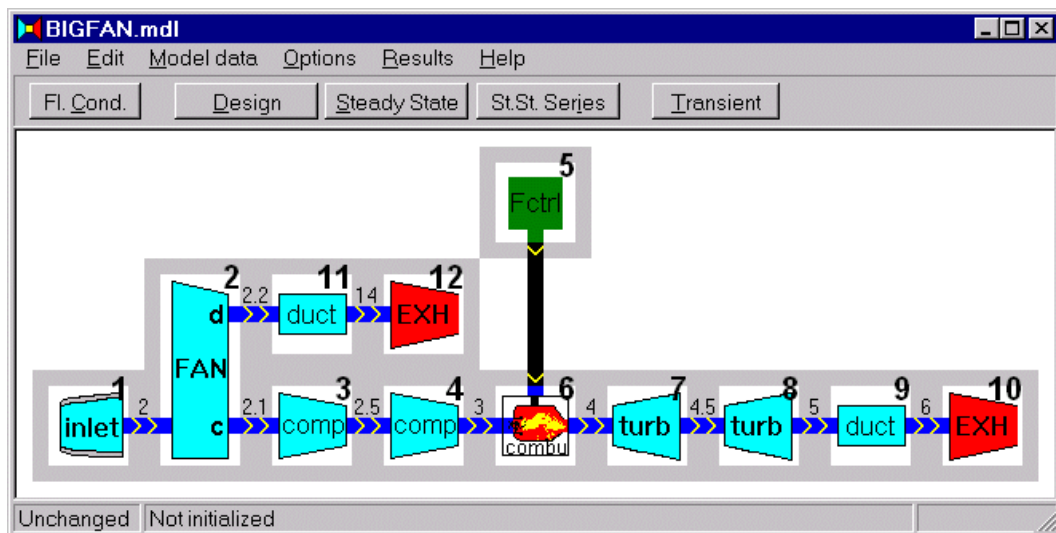

Figure 5 : BIGFAN model window

Let us assume we are interested in sea level take-off performance at varying ambient temperatures and compressor bleed flows. This implies the calculation of steady-state points at a series of different ambient temperatures, with the engine running at either maximum total turbine inlet temperature $Tt4$ (or TIT) or maximum burner pressure $Ps3$ (i.e. a flat rated engine). If we assume a flat rated temperature FRT at 288 K, then the engine is at both maximum $Tt4$ and $Ps3$ at design point ambient temperature 288 K.

First, a design point calculation with a $Tt4$ of 1554 K is executed. Then, an ambient temperature 'parameter sweep' from 280 K up to 320 K is performed, while maintaining the 1554 K for $Tt4$. The parameter sweep is performed both for no bleed and for 5% compressor bleed. The results in Figure 6 show the typical turbofan trends for fan speed $N1$, compressor speed $N2$, engine pressure ratio EPR and net thrust FN used for specifying take-off performance at temperatures above FRT.

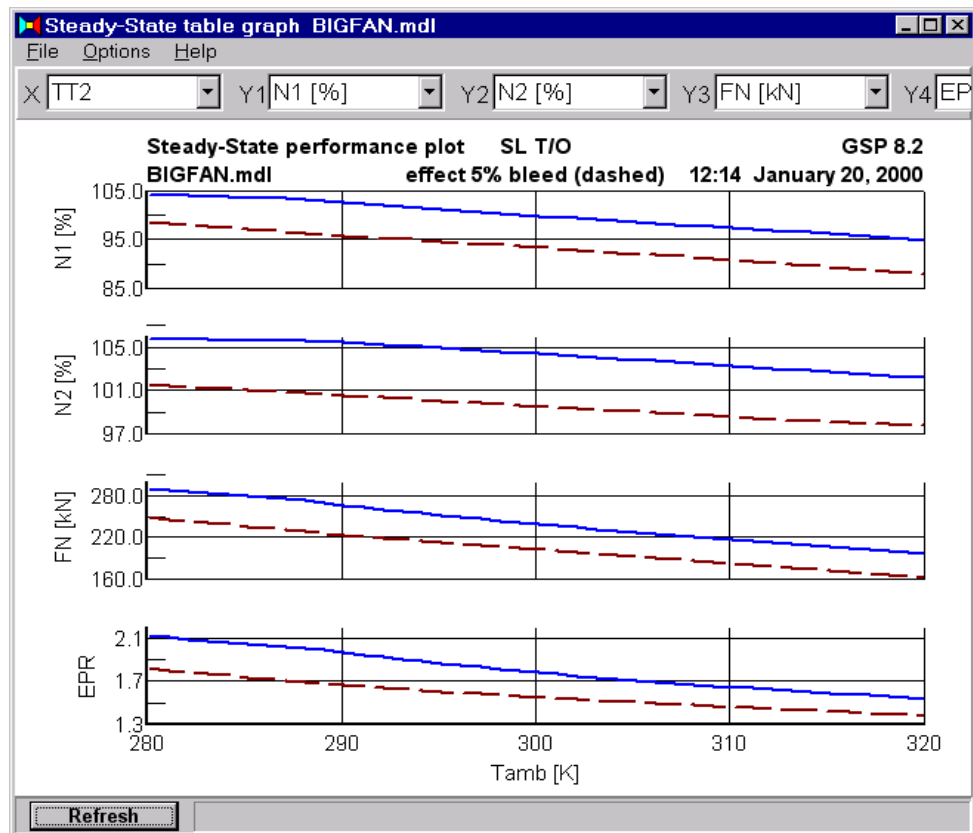

Figure 6 : Effect of compr. bleed on take-off performance

Figure 6 further shows GSP's X-Y plot output window enabling the user to select an X and up to 4 Y parameters from pull-down list boxes with (depending on the model and the user selected output) usually over 50 performance parameters.

Next, the performance below FRT must be obtained. Here we are interested in operating points at constant maximum Ps3 level (i.e. flat rated operating points). GSP is not able to keep any non user-specified variable such as Ps3 constant during parameter sweep steady-state calculations. The combustor component allows specification of fuel flow, Tt4 or fuel-to-air ratio FAR as input values only (this series could be extended in a custom component).

However, constant Ps3 operating points can easily be obtained by calculating a number of parameter sweeps varying ambient temperature Tamb at a number of decreasing Tt4 (i.e. decreasing power) levels. In Figure 7 this is demonstrated. The solid curve represents the maximum Tt4 line, the other two curves are for Tt4 at 1450 K and 1380 K respectively. The maximum Ps3 is 28.9 bar, i.e. the intersection of the solid curve with the 288 K vertical line.

The intersections of the other two lines indicate two N1 values for maximum Ps3 at lower ambient temperatures: 99% N1 at around 268 K and 96% N1 at around 253 K. With more parameters sweeps an accurate N1 take-off power setting curve can be generated, also for the 5% compressor bleed case.

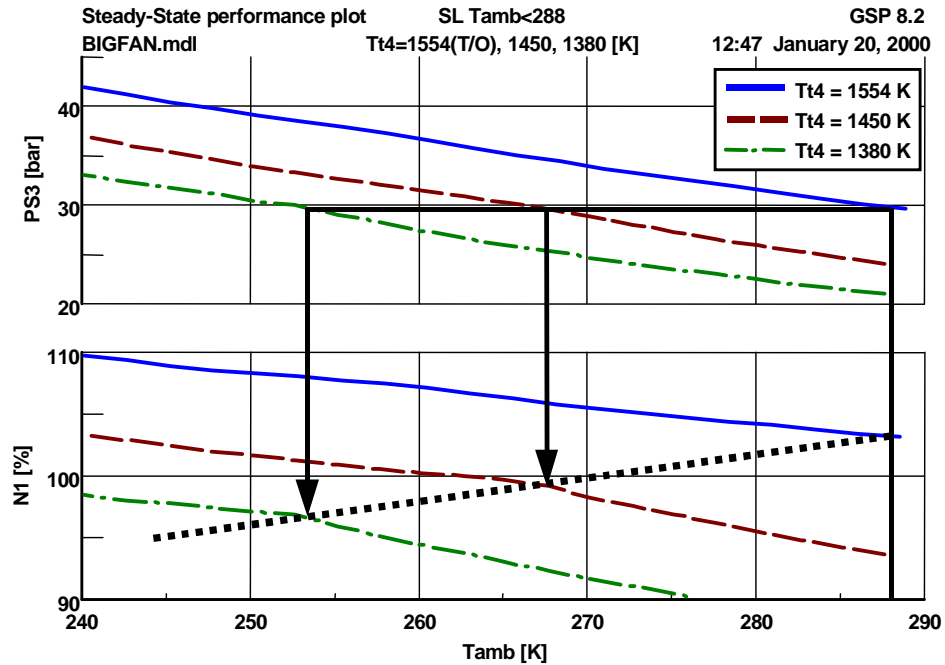

Figure 7 : Sub-FRT turbofan take-off performance

Recuperated turboshaft engine

The simulation of a recuperated turboshaft gas turbine demonstrates GSP's flexibility for building a model. The model depicted in Figure 8 is simply derived from an existing turboshaft engine model. Using GSP's drag & drop interface for adding a simple recuperator (heat exchanger HX) model and some 'link bars' to make the proper gas path connections, a gas turbine is extended with a recuperator.

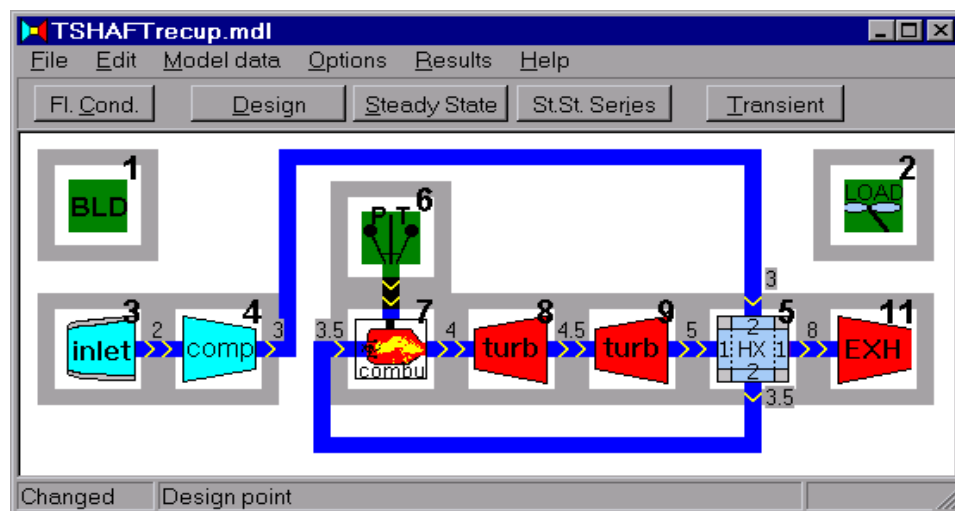

Figure 8 : Recuperated turboshaft model

Now, the user can focus on the real work to be done: redefine the design point with a new (lower) fuel flow, additional pressure losses in the recuperator and modified control schedules in the power turbine (PT) speed control component. The latter task is complicated due to the relatively unstable nature of the recuperated cycle. An effective and stable control system design (maintaining constant PT speed with torque variations) requires separate attention to optimise the PID control system gains. With GSP, effects of different gains can be analysed combined with accel and decel schedules.

Important issues are the volume and heat soakage effects of the recuperator. When these are substantial, accurate PT speed control is hard to achieve. With GSP, these effects can be analysed in detail with several kinds of transient response simulations. Figure 9 shows recuperator volume effects on engine response (the dashed line is with 0.1 m³ volume for both hot and cold flow passages, the solid line is without recuperator volume). Mdot_cold shows the rate of mass content change in the cold flow passage volume.

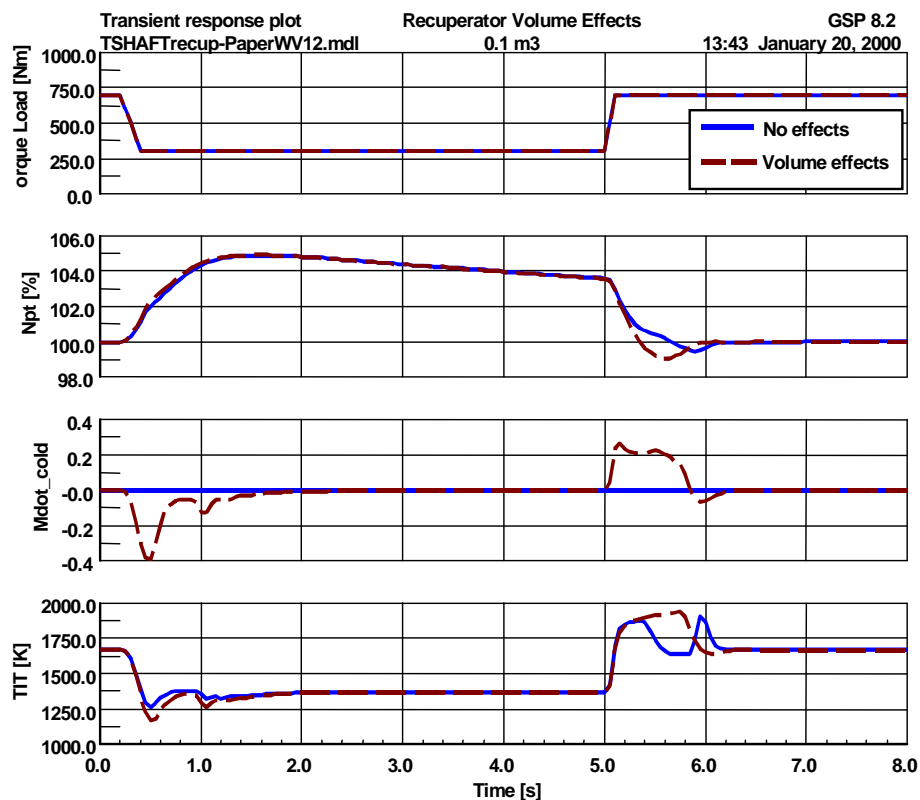

Figure 9 : Analysis of recuperated turboshaft volume effects

Note that Figure 9 shows the response of a non-optimised control system. During acceleration, the nominal Tt4 is exceeded, especially when including the volume effects. Also, the PT rotor speed Npt dip (down to 99%) is entirely due to the volume effects. The solid curve (no volume effects) indicates virtually no dip at all.



Lift-fan driven by afterburning turbofan engine

An interesting problem requiring a high degree of flexibility is the integrated simulation of an afterburning turbofan engine driving a lift-fan through a clutch, engaging and disengaging the lift-fan driveshaft from the fan shaft while the engine is running. GSP offers the flexibility to model such a complete system, enabling thorough analysis of its performance, including lift-fan-engine interaction, optimising control logic, drive shaft rotor dynamics and torque loads. The lift-fan will only require minor modelling effort since it can inherit most of its code from the compressor or fan component. For the clutch, new relations must be implemented for transmitting torque between engine and lift fan, depending on the clutch engagement schedule.

One of the challenges modelling the lift-fan was to make GSP able to handle rotating turbomachinery components at zero speed levels. The lift fan model and the numerical solver required some adaptations to allow model states at zero (zero speed and mass flow).

In Figure 10, the model of the afterburning (AB) turbofan driving a lift-fan is shown. A lift-fan model and a simple clutch model are added to an AB turbofan model. The turbofan has 85 kN (max dry) rated thrust, 100 kg/s airflow, an overall pressure ratio PR of 39 and a maximum Tt4 of 2050 K. The lift-fan has 47 kN thrust at 100% speed (fully engaged at full turbofan speed) and 130 kg/s air flow.

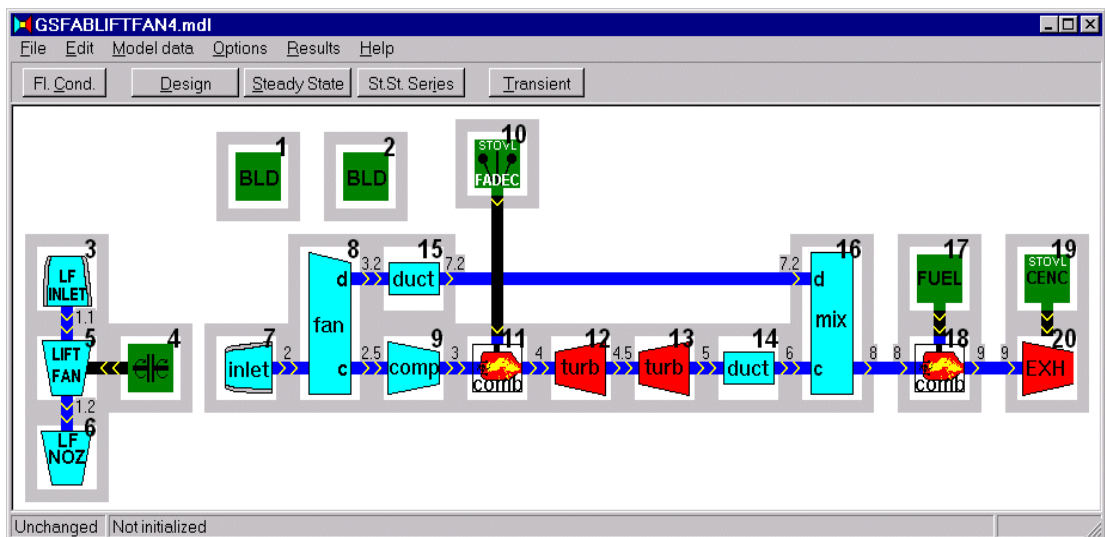

Figure 10 : Model of AB turbofan driving lift-fan

The engine system design point can either be specified with engaged or disengaged lift-fan. In this example a disengaged fan is used at design so as to have a customary AB turbofan configuration as the design point reference.

The AB turbofan has a Full Authority Digital Electronic Control (FADEC) model controlling fan speed with fuel flow and engine pressure ratio EPR with exhaust nozzle area. With the lift-fan engaged, power is obtained from the fan shaft. Fan speed can be maintained by increasing



fuel flow but this may well result in an unacceptable increase of $Tt4$ and compressor speed $N2$. Increasing exhaust nozzle area offers a means to increase fan shaft power without this problem.

The turbofan exhaust nozzle and additional roll-rate control air bleed nozzles will also provide vertical thrust during lift-fan operation. Although this affects system performance and may well be modelled using GSP also, this aspect is not addressed in this example. Also AB operation is not used in this example.

A very important aspect is how to control engagement and disengagement of the clutch. With GSP, effects of different (dis)engagement turbofan speed windows, engagement duration times, clutch maximum torque capacities, detailed clutch characteristics and lift fan variable geometry on system performance can be analysed. Important parameters then are maximum lift-fan drive shaft torque levels, clutch friction heat production rates, clutch total engagement heat production, clutch slipping time durations, fan speed and lift fan speed responses, $Tt4$ response, turbofan exhaust nozzle thrust response and system control stability.

For the lift-fan AB turbofan system 6 custom components had to be derived from the existing GSP standard classes: a lift-fan component inherited from the compressor component class, a clutch component derived from the abstract control component class, a lift-fan inlet component derived from the standard inlet, a lift-fan nozzle derived from the variable nozzle class, a FADEC fuel control derived from the generic fuel control component class and a variable exhaust nozzle control derived from the generic nozzle control class, interfacing with the FADEC. These components all have functionality added specific for this type of configuration. The component user interfaces have been extended to enable quick adaptation of control logic, gains and schedules, and clutch and lift-fan characteristics. This enables quick analysis of the effects of numerous variations in the configuration. When detailed specific characteristics are known and available (such as detailed digital control logic), these can easily be implemented in extended custom component classes.

In Figure 11 to Figure 14, responses of subsequent lift-fan engagement and disengagement are shown for two cases. The solid curves represent the case with a 14000 Nm maximum (fully engaged) static torque capacity clutch. The dashed curves represent a clutch with 28000 Nm maximum static torque capacity (maximum dynamic torque capacity is somewhat lower).

The turbofan engine initially runs at 100% speed without the lift-fan engaged, thus the lift fan speed is 0. The control is simplified, with $N1$ control using customary fuel flow/burner pressure schedules. Furthermore, a PID controller was defined, maintaining scheduled EPR combined with a separate open loop nozzle schedule for lift-fan operation using the exhaust nozzle area.

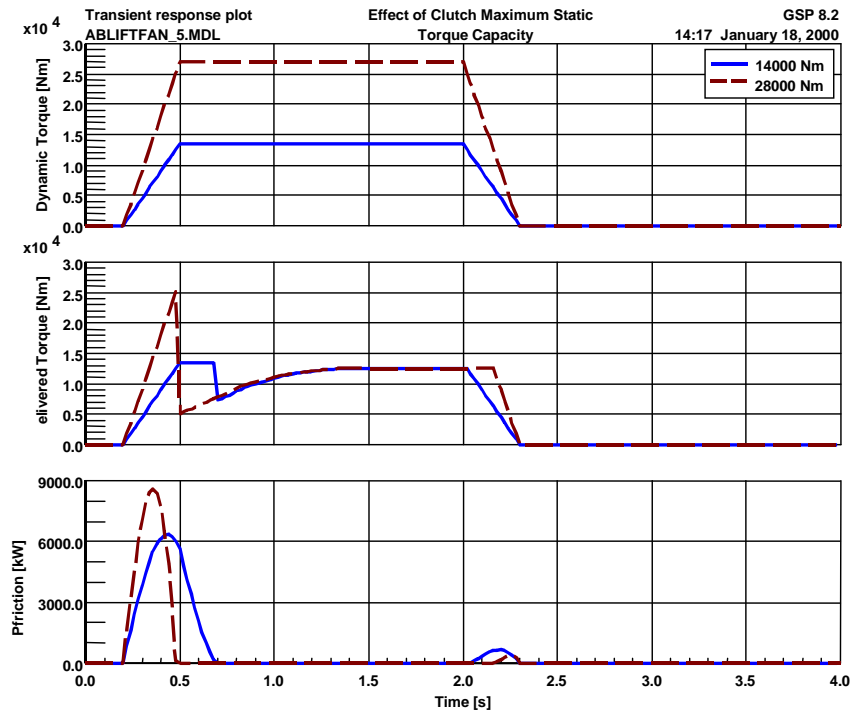

Figure 11 : Lift-fan (dis)engagement clutch response

Figure 11 shows clutch parameter responses versus time for lift-fan engagement (starting at 0.2 s) and disengagement (starting at 2 s). The top graph shows clutch engagement in terms of (dynamic friction) torque capacity. Next actual torque delivered to the lift-fan and the heat dissipation (Pfriction) during clutch slipping are shown.

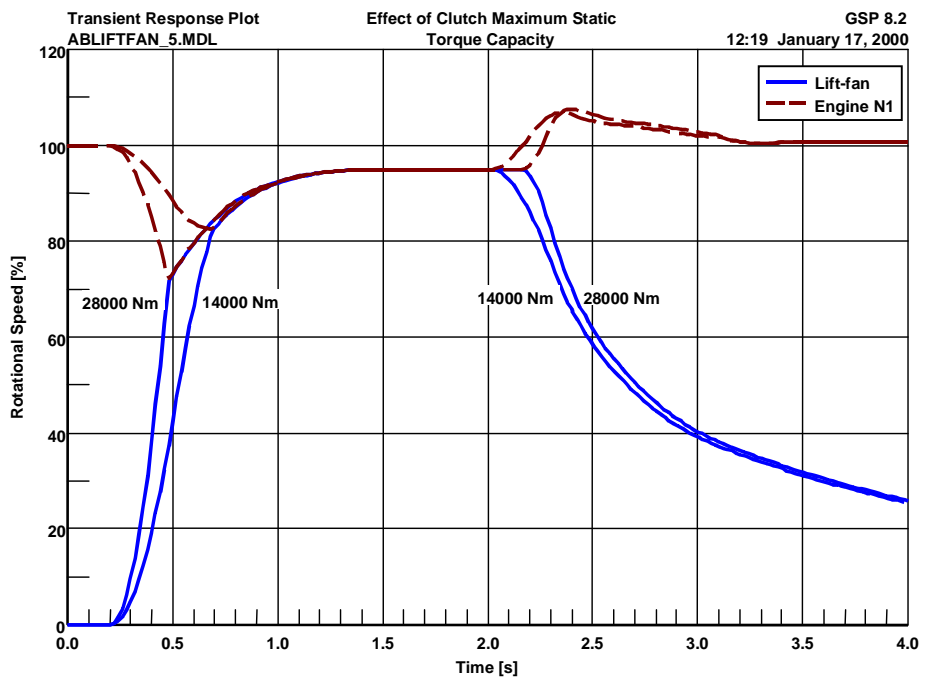

Figure 12 : Lift-fan (dis)engagement lift-fan & N1 response



Figure 12 shows the rotational speeds of the lift-fan and the engine fan in a single graph, effectively summarising rotor speed and clutch performance histories.

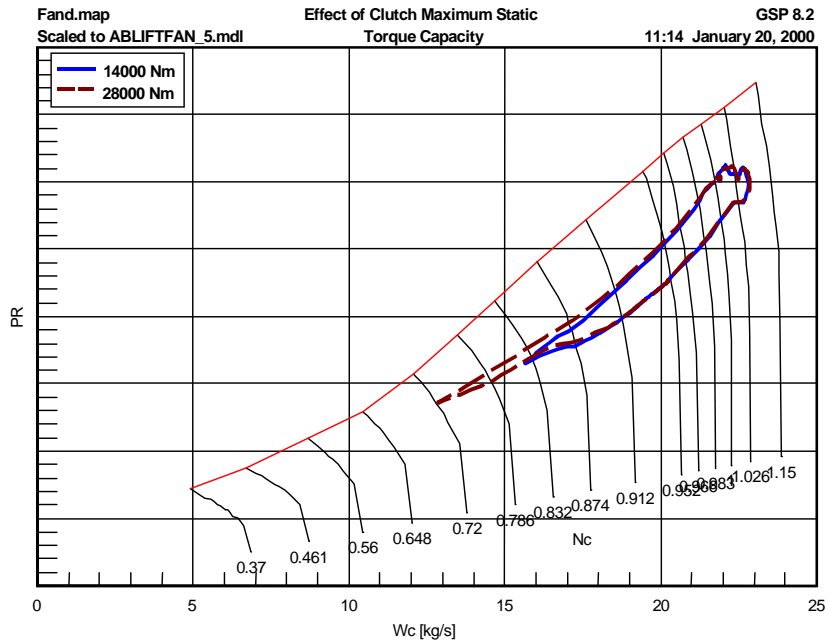

Figure 13 : Lift-fan (dis)engagement in fan duct map

Figure 13 shows the transient operating curve in the fan duct map and Figure 14 shows thrust and turbofan nozzle and N2 responses.

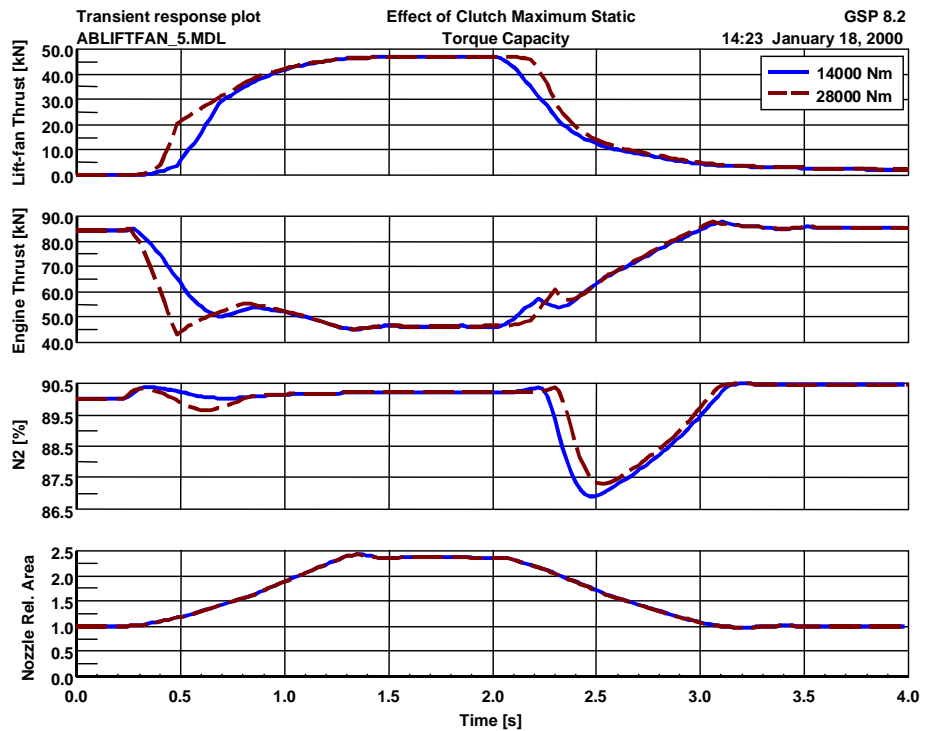

Figure 14 : Lift-fan (dis)engagement engine response

Note that the solid curves in Figure 11 indicate quite a long engagement (slipping) time of the clutch, which may be favourable in terms of smooth engagement but unfavourable in terms of friction heat rate. The dashed curves show the same response with a higher clutch maximum static torque capacity, which reduces the locking time (and friction heat production) significantly. However, the N1 response now shows an increased dip as displayed in Figure 12.

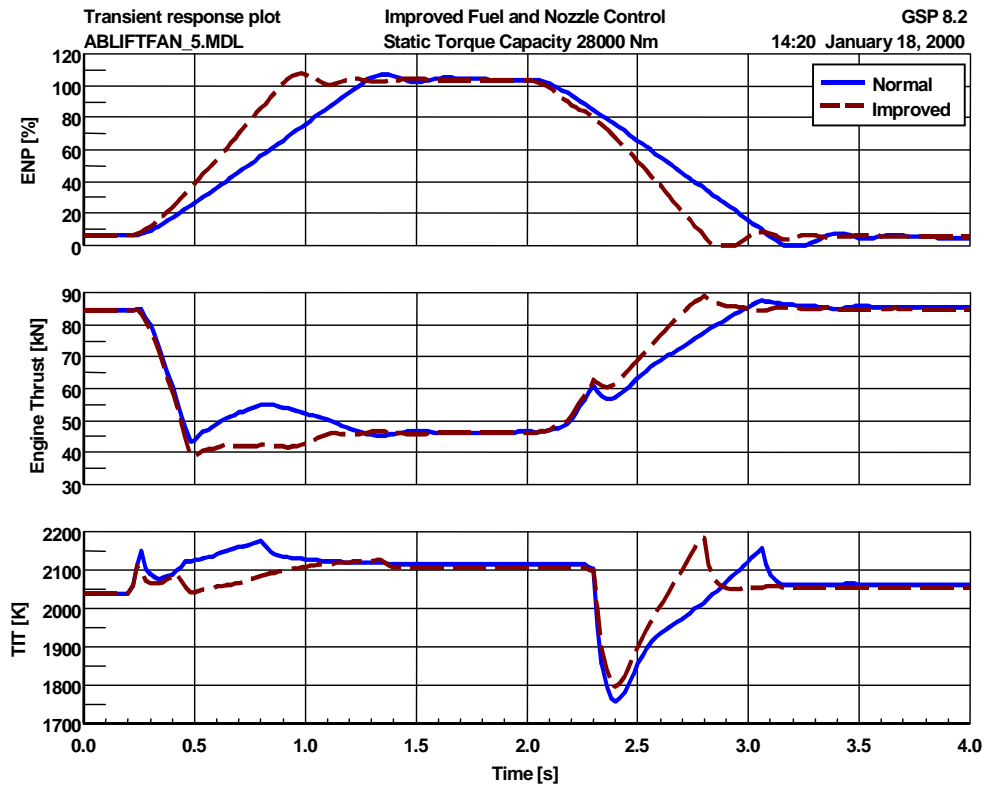

Figure 15 : Lift-fan (dis)engagement response with faster nozzle actuator and lower max. accel fuel

Figure 15 shows the results for a more optimised control system (dashed curves), incorporating a higher nozzle actuator rate and a lower maximum acceleration schedule. The higher nozzle actuator rate allows the engine control to better maintain EPR, while the lower maximum acceleration schedule better limits Tt4 to acceptable levels.

Other applications

Many other application examples exist, some of which are included in the sample models of the demo version (see footnote on page 3).

An interesting application has been the analysis of effects of alternative fuels for industrial turboshaft engines, reported in Visser and Kluiters (1999). This reference includes examples of the application of GSP's multi-reactor combustor model for prediction of exhaust gas emission levels. A follow-up to this work is the development of a biomass gasifier component for



performance analysis of a combined gas turbine-biomass gasifier system. Here the gasifier obtains air from the gas turbine, and delivers low calorific value fuel to the gas turbine.

Tinga et al (2000) use GSP as an element in a series of models for analysis of thermal load calculation for gas turbine hot section life consumption modelling.

CONCLUSIONS

The GSP gas turbine simulation environment is a powerful tool for gas turbine system performance analysis. The architecture has proven its benefits in terms of flexibility with a variety of applications. The object orientation has facilitated numerous rapid developments of application specific custom components requiring relatively small effort.

The GSP user interface combined with on-line help has proved user-friendly to many using GSP as a tool to build and use a variety of gas turbine models.

GSP is continuously being improved and extended. GSP's standard modelling capabilities are extended based on user demands. Many of those however are rather specific and result in custom components in order to prevent unnecessary complexity (too many features) in the standard and generic components. Many improvements are focused on the user interface, especially helping the user identify erroneous or invalid inputs, causes of certain model behaviour, simulation problems etc.

GSP's flexibility will prove valuable to future applications such as performance analysis of complex recuperated intercooled cycles, multi-stage combustion (with the multi-reactor combustor model), detailed simulation of STOVL propulsion systems and tilt-rotor propulsion system simulation.

REFERENCES

- Booch, G., 1991, 'Object Oriented Design with Applications', Benjamin/Cummings Publishing, 1991.
- Glassman, I., 1996, 'Combustion', Princeton NJ, USA: Academic Press.
- Kuo, K.K., 1986, 'Principles of Combustion', New York: John Wiley & Sons.
- Kurzke, J., 1995, 'Advanced User-friendly Gas Turbine Performance Calculations on a Personal Computer', ASME Paper 95-GT-147.
- Kurzke, J., 1996, 'How to get Component Maps for Aircraft Gas Turbine Performance Calculations', ASME Paper 96-GT-164.



McBride, B.J., and Gordon, S., 1994-1996, 'Computer Program for Calculation of Complex Chemical Equilibrium Compositions and Applications', NASA Reference Publication 1311. Ohio, National Aeronautics and Space Administration, Lewis Research Center.

Tinga, T, Visser, W.P.J, de Wolf, W.B. and Broomhead M.J., 2000, 'Integrated Lifting Analysis Tool for Gas Turbine Components', ASME-2000-GT-0646.

Visser, W.P.J., 1995, 'Gas Turbine Simulation at NLR', 'Making it REAL', CEAS Symposium on Simulation Technology (paper MOD05), Delft, the Netherlands.

Visser, W.P.J., and Kluiters, S.C.M., 1999, 'Modelling the Effects of Operating Conditions and Alternative Fuels on Gas Turbine Performance and Emissions', NLR Technical Publication NLR-TP-98629 or Research and Technology Organisation, RTO-MP-14.