



NLR-TP-98338

AIRSIM,
a desktop research flight simulator

J. Groeneweg



NLR-TP-98338

**AIRSIM,
a desktop research flight simulator**

J. Groeneweg

This report is based on a presentation held at the AIAA "Modelling and Simulation Technologies Conference", Boston, U.S.A., 10-12 August 1998.

The contents of this report may be cited on condition that full credit is given to NLR and the author.

Division:	Flight
Issued:	October 1998
Classification of title:	unclassified



Summary

AIRSIM, which is short for Avionics Integration Research SIMulator, is an integrated desktop research flight simulator, meant for avionics development and tests checkout of research simulator and research aircraft experiments, accident investigation analysis and Air Traffic Control (ATC) simulations. Developed at the National Aerospace Laboratory NLR, AIRSIM can be used as a high fidelity, low cost flight simulator, as a computer-based trainer and as a familiarization tool for aircraft behaviour and cockpit instruments. AIRSIM offers the same basic functionality as NLR's research flight simulator and has a highly configurable and flexible setup.



Contents

Abbreviations	4
1 Introduction	5
2 Development philosophy	6
3 Architecture	7
4 Characteristics	12
5 Applications	13
5.1 AIRSIM in combination with other applications	13
5.2 AIRSIM used as an avionics display software tester	13
5.3 AIRSIM used in incident/accident analysis	14
5.4 AIRSIM used in experiments	14
5.5 Applications at present and in the future	15
6 Conclusion	16



Abbreviations

AIRSIM	-	Avionics Integration Research SIMulator
AOM	-	Aircraft Operations Manual
ATC	-	Air Traffic Control
CBT	-	Computer Based Trainer
EFIS	-	Electronic Flight Instruments System
NLR	-	National Aerospace Laboratory
FDR	-	Flight Data Recorder
FMPDCP	-	Flight Mode Panel / Display Control Panel
FS98	-	Microsoft Flight Simulator 98
GPWS	-	Ground Proximity Warning System
ILS	-	Instrument Landing System
MCP	-	Mode Control Panel
MCS	-	Multi Cockpit Simulator
NAVSEL	-	NAVigation source SElection
NDB	-	Non-Directional Beacon
OTWV	-	Out-The-Window-View
PC	-	Personal Computer
PS1	-	Aerowinx Precision Simulator 1
RFMS	-	Research Flight Management System
RFS	-	Research Flight Simulator
TCAS	-	Traffic Collision and Avoidance system
TMX	-	Traffic and Experiment Manager
VHF	-	Very High Frequency
VOR	-	VHF Omni directional Radio Range



1 Introduction

About seven years ago it was possible to buy a voluminous graphics workstation that costs about \$100,000. Nowadays it is possible to buy graphics workstations for about 10 percent of that amount with the same computing power and small enough to fit somewhere on your desktop. This development has made it possible that people can buy low-cost graphics workstations and yet run high graphical performance demanding applications while sitting behind their desk. One of these applications is AIRSIM (Figure 1).



Figure 1. AIRSIM

AIRSIM is a flight simulator such as the PC-based Microsoft Flight Simulator '98 (FS'98) or Aerowinx Precision Simulator 1 (PS1). Although built for different purposes these flight simulators have one commonality. They all depend heavily on the graphical performance of the computer.

This paper gives an overview of why NLR has developed AIRSIM, what this flight simulator is, how it works, what its characteristics and advantages are and how it can be used.



2 Development philosophy

The main reason for the development of AIRSIM is to have a low-cost research flight simulator available with the same fidelity as the Research Flight Simulator (RFS) but without the use of an entire simulator hardware facility. Especially during the first phase of developing and testing avionics display software, AIRSIM is a practical tool, as the developer becomes independent of the availability of the RFS.

In the second development phase porting the fully tested avionics display software to the RFS is easy, because common interfaces are being used. In this way, new avionics displays become available for evaluation experiments in a cost-effective way.

Day to day practice has proven that AIRSIM is not just an avionics development and testing tool. Several specific developments have made it possible that it is also used purely as a flight simulator and as an incident/accident investigation analysis tool. What these developments are, is described in the next chapter.



3 Architecture

AIRSIM has an object oriented and distributed architecture. This means that it is built upon several modules (programs) each with a separate data structure and functions. These modules communicate via a relatively small (Ethernet) interface.

At this moment AIRSIM (Figure 2) consists of four main modules:

- Multi Cockpit Simulator (MCS)
- Electronic Flight Instruments System (EFIS)
- Generic Flight Mode Control Panel and Display Control Panel (FMPDCP)
- Out-The-Window-View (OTWV)

MCS, EFIS, FMPDCP and OTWV are also used in NLR's Research Flight Simulator (RFS) facilities.

In the near future other modules will be added, see chapter "Applications at present and in the future".

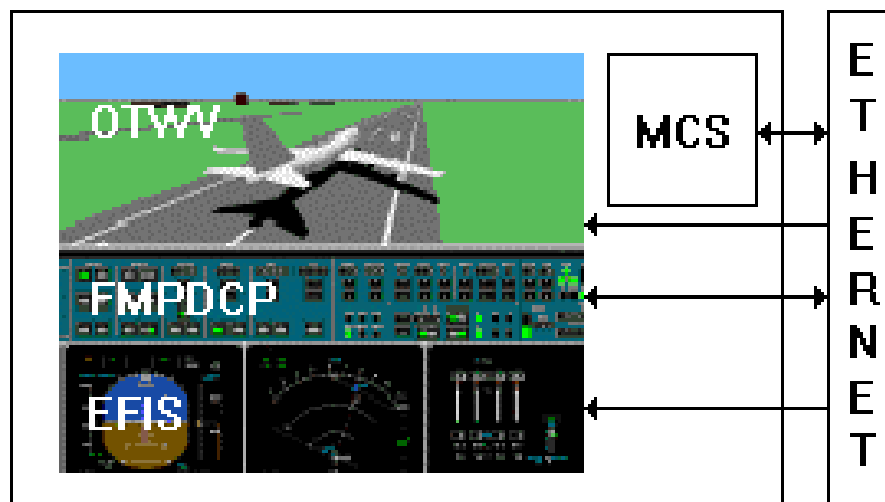

Figure 2. AIRSIM component breakdown

As shown in Figure 2 all four components communicate via Ethernet. This makes it possible to run all modules independently. You may want to run them on one workstation but it is also possible to run the modules simultaneously on several workstations under the condition that they are connected through Ethernet.

The first main module is a Multi Cockpit Simulator (MCS, Figure 3). MCS is derived from the RFS host simulation program. It is a generic flight simulator capable of simulating several kinds of aircraft. MCS as used in AIRSIM, has a Fokker-100, a Boeing 747-400, a Fairchild Metro II turboprop and an Airbus-310-like flight simulation model. Other models can be implemented easily.



For each aircraft model MCS has program routines that are capable of simulating the aircraft characteristics such as the aerodynamics, the engine dynamics and the landing gear. Other routines simulate aircraft systems such as navigation and communication (ILS, VOR, NDB) and auto-pilot and auto-throttle systems. Last but not least MCS is equipped with a well-documented input and output interface which makes it easy to integrate MCS in AIRSIM.

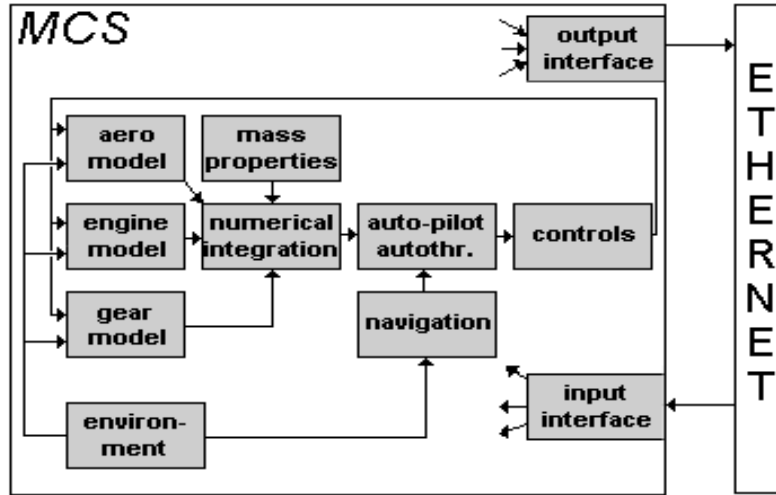

Figure 3. MCS

The second module of AIRSIM is an EFIS (Figure 4). In AIRSIM the EFIS consists of Primary Flight Display's and Navigation Display's - either from the Fokker-100 or Boeing 747-400 -, a Fokker-100 Engine Display or a Boeing 747-400 primary EICAS display. In the EFIS each display is a separate module. This way it is possible to mix aircraft depended displays as shown in Figure 4 where Fokker-100 PFD and ND are combined with a Boeing 747-400 EICAS display. All displays have been built using Fokker-100/Boeing 747-400 EFIS description and Aircraft Operations Manuals (AOM). All mentioned EFIS displays are also used in the RFS and are therefore easily portable and exchangeable.



Figure 4. EFIS



The third module of AIRSIM is a generic Flight Mode Panel and Display Control Panel (FMPDCP, Figure 5) that interfaces via Ethernet (Figure 2) with MCS and EFIS. The FMPDCP includes a Mode Control Panel (MCP = FMP) to select auto pilot functions, a Display Control Panel (DCP) to control EFIS displays, a NAVigation source SElection (NAVSEL) panel and primary and secondary controls.

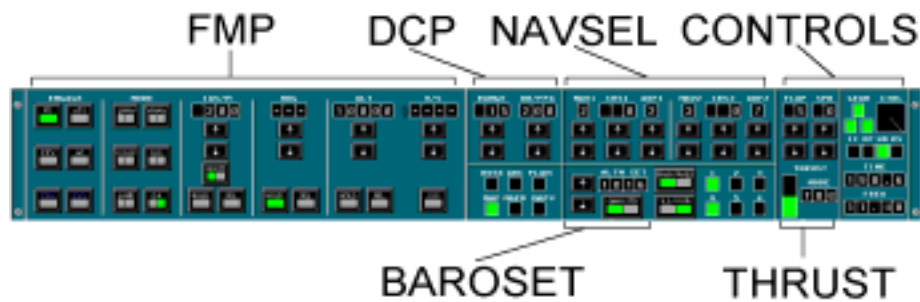

Figure 5. FMPDCP

The fourth module of AIRSIM is an Out-The-Window-View (OTWV). This OTWV is used primarily to give a view from the cockpit (Figure 6) or from a 'wingman' position (Figure 1).



Figure 6. OTWV 'cockpit view'



Figure 7. OTWV 'tower view'

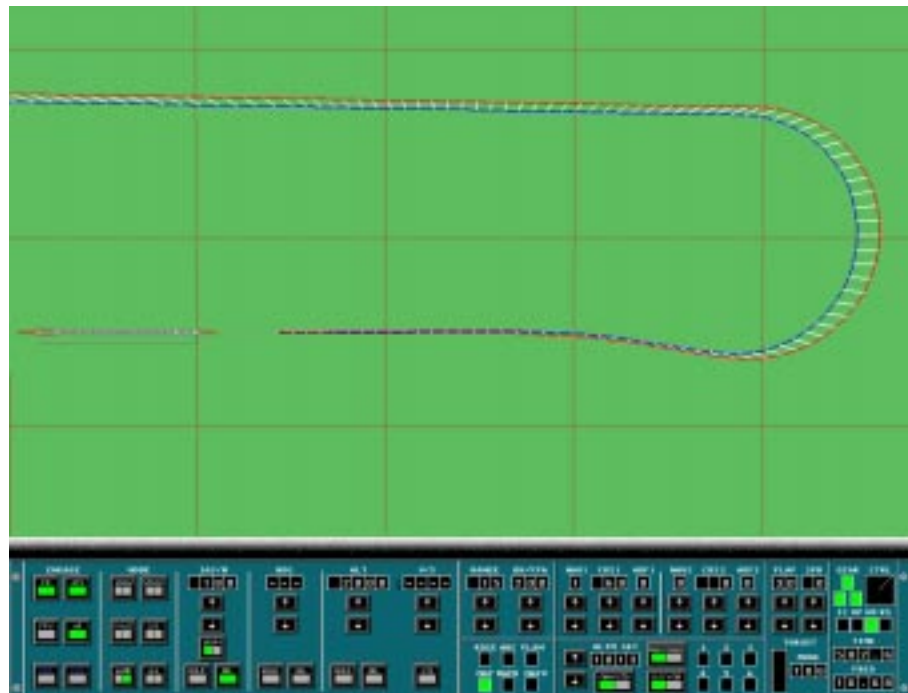

Figure 8. OTWV 'random view'



In other cases OTWV can be used to give a view from a 'tower' position (Figure 7) or from a 'random' position (Figure 8). In order to add realism OTWV is capable of simulating certain weather conditions such as fog and clouds. Furthermore OTWV has other visualisation accessories to increase realism like mountains, lakes, airfields and different graphical aircraft models. A very useful OTWV feature often used in accident analysis is a flight-path history (shown in figures 7 and 8). This is a two-dimensional presentation of a three-dimensional flown trajectory.



4 Characteristics

AIRSIM can be characterized in several ways. Because AIRSIM has all the elements of a research flight simulator it can be characterized as a low-cost research flight simulator on your desktop. Next to that AIRSIM is characterized as a very flexible tool. This flexibility is realized in several ways.

Firstly, AIRSIM has a modular architecture. This makes it possible to use only those modules that are necessary for your application. Additionally the modular architecture including the Ethernet communication makes it possible to run modules on different workstations and to connect new modules such as avionics displays to AIRSIM.

Secondly, AIRSIM has a very flexible user interface. All modules can be controlled either using the keyboard and mouse or a special joystick or other flight controls.

Finally, AIRSIM has a flexible start-up interface. This makes it possible to choose which modules will be selected and especially how MCS is used – for instance which aircraft model is used. The start-up interface can easily be adapted to your (new avionics) modules and in this way made part of AIRSIM.



5 Applications

To a certain extent AIRSIM can be compared with FS98 or PS1. All these flight simulators are cost-effective and can be used as familiarization tools to learn aircraft behavior and operations and as a Computer Based Trainer (CBT). But AIRSIM has more possibilities.

AIRSIM is specially made for avionics development and testing. Furthermore it can be used in Air Traffic Control (ATC) Simulations, testing and evaluating simulator set-ups and aircraft incident/accident analysis. AIRSIM runs on UNIX Silicon Graphics workstations.

The next five chapters give a more detailed idea of how AIRSIM can be used.

5.1 AIRSIM in combination with other applications

To improve the flexibility and usefulness of AIRSIM, it can be connected to several other applications that are not (yet) part of AIRSIM. An important link is made with the NLR's Research Flight Management System (RFMS). This application is capable of simulating a Honeywell/Collins/Boeing-like Flight Management System. Secondly AIRSIM can be connected with a Traffic and Experiment Manager (TMX). This application is capable of simulating an entire airspace - in which AIRSIM simulates one of the aircraft - and controlling the experiment. Finally AIRSIM can be interfaced with a Traffic Collision and Avoidance System (TCAS) and a Ground Proximity Warning System (GPWS) module. The TCAS module gives AIRSIM TCAS functionality and the GPWS module gives AIRSIM all the aural warnings.

5.2 AIRSIM used as an avionics display software tester

Most of the time AIRSIM is used for avionics display software development and testing. Before a new avionics display is evaluated the display is equipped with the standard AIRSIM Ethernet interface which is used by all AIRSIM modules (Figure 9). At first the display is tested for its basic functionality. When doing this, the OTWV and EFIS are used as a reference since these modules are validated.

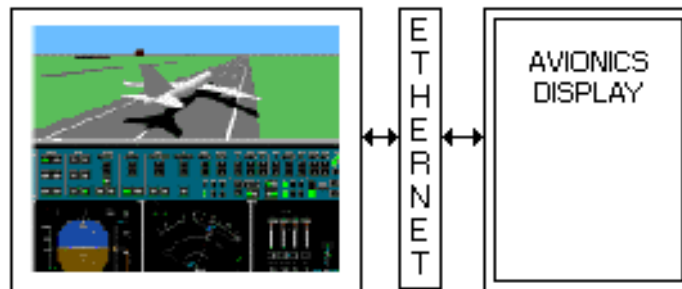

Figure 9. AIRSIM used as avionics tester



When the basic functionality test is completed, the display can be evaluated for its operational and ergonomic capabilities in the RFS or in the Citation II (=NLR's laboratory aircraft).

5.3 AIRSIM used in incident/accident analysis

For accident investigation analysis AIRSIM can be used as a visualization tool in two ways: for technical analysis and for incident/accident prevention.

During the technical analysis of the accident usually Flight Data Recorder (FDR) data is used to reconstruct the last few minutes of the flight. It is also possible to use MCS and reproduce the FDR data. In both cases AIRSIM provides a clear impression of what has happened in the last minutes of the flight. When using MCS it may also give insight in other information such as flight controls input.

AIRSIM can also be used in incident/accident prevention. This can be achieved by using the visualization to compile a video-animation. These animations are part of instruction videos used as illustrative medium to instruct pilots.

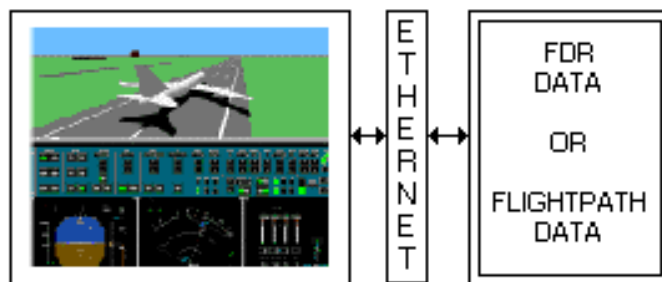

Figure 10. AIRSIM used in accident analysis

5.4 AIRSIM used in experiments

AIRSIM can easily be used in simulation experiments. This can be done in different ways. At first AIRSIM can be used as a second aircraft in a flight simulation set-up. This is very useful since interaction between two aircraft can be a point of interest during an experiment. Secondly AIRSIM can be used in an ATC simulation set-up as a 'blib-driver'. That means that in experiments with air traffic AIRSIM simulates a particular aircraft. This way certain anomalies/non-normal events can be studied.

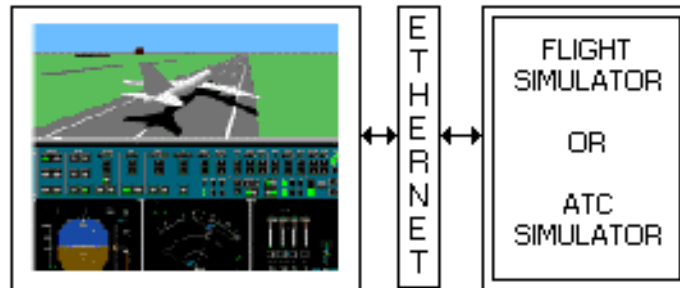

Figure 11. AIRSIM used in experiments

Just recently AIRSIM has been used twofold in a simulator experiment regarding the Free Flight concept. Apart from the normal use during the development phase, in which important new features in the Navigation Display (ND) and Primary Flight Display (PFD) were tested, AIRSIM was also used during the evaluation trials to simulate other traffic. An important point of interest in this experiment was the interaction between two (or more) aircraft.

5.5 Applications at present and in the future

AIRSIM has been and will be distributed to other NLR departments who will be using it as an avionics display software development and test tool. Furthermore AIRSIM will be used as a training tool for (new) employees that work in the field of flight simulation, incident/accident investigation and avionics display development. With this tool they can become more familiar with cockpit instruments and aircraft behavior. AIRSIM has been and will be used in several incident/accident investigation analyses.

In the future AIRSIM will be fully integrated with the RFMS, the TMX, TCAS and GPWS module. After that AIRSIM will be equipped with an ARINC 429 interface to test avionics hardware.



6 Conclusion

For NLR AIRSIM has proven to be a very cost-effective flight simulator that can do more than other comparable flight simulators. The most important feature that AIRSIM offers, is the flexibility. AIRSIM can be used for many more purposes other than pure entertainment or Computer Based Training. It is mainly used for avionics display software development, incident/accident analysis and flight simulation and ATC experiments. Since AIRSIM is flexible in many ways it is a very user-friendly flight simulator with great user potential.