



Dedicated to innovation in aerospace

NLR-TP-2017-370 | April 2018

Collaborative Design of Aircraft Systems - Multi-Level Optimization of an Aircraft Rudder

CUSTOMER: European Commission



NLR – Netherlands Aerospace Centre

Netherlands Aerospace Centre

NLR is a leading international research centre for aerospace. Bolstered by its multidisciplinary expertise and unrivalled research facilities, NLR provides innovative and integral solutions for the complex challenges in the aerospace sector.

NLR's activities span the full spectrum of Research Development Test & Evaluation (RDT & E). Given NLR's specialist knowledge and facilities, companies turn to NLR for validation, verification, qualification, simulation and evaluation. NLR thereby bridges the gap between research and practical applications, while working for both government and industry at home and abroad.

NLR stands for practical and innovative solutions, technical expertise and a long-term design vision. This allows NLR's cutting edge technology to find its way into successful aerospace programs of OEMs, including Airbus, Embraer and Pilatus. NLR contributes to (military) programs, such as ESA's IXV re-entry vehicle, the F-35, the Apache helicopter, and European programs, including SESAR and Clean Sky 2.

Founded in 1919, and employing some 650 people, NLR achieved a turnover of 71 million euros in 2016, of which three-quarters derived from contract research, and the remaining from government funds.

For more information visit: www.nlr.nl

Collaborative Design of Aircraft Systems - Multi-Level Optimization of an Aircraft Rudder

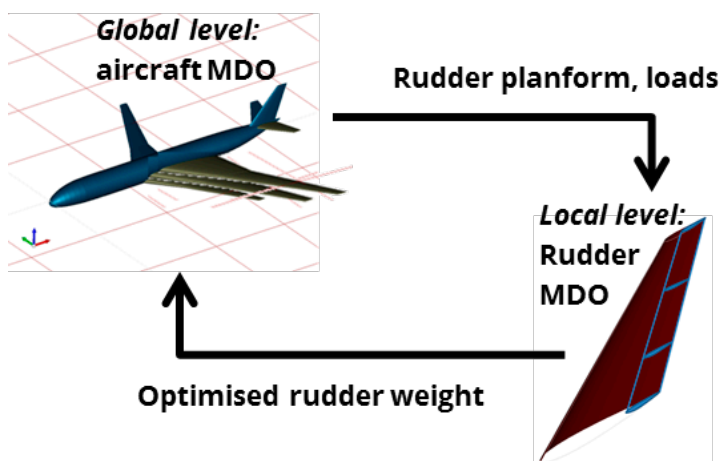

Problem area

Over the past century, aircraft design and development has evolved from pioneering – one or few people building a simple and small aircraft in a shed – into a highly complex but well-established engineering process. Today, aircraft are highly advanced technological and competitive products that are developed by large and many multi-disciplinary teams of experts from different companies, usually located in several countries. Besides the aircraft integration and final assembly by the Original Equipment Manufacturer (OEM), many sub-systems and parts of the aircraft are developed by tier 1 and 2 suppliers. The suppliers are responsible for their own part or system design, while the OEM is responsible for the overall aircraft design and the interfaces between the aircraft systems/parts. Tier 1 suppliers often share responsibility and investment risk with the OEM for the delivery of a successful aircraft. This increases the need for collaborative design approaches. In particular, there is a need for efficient methods that address the problem of design optimization on aircraft level as well as on sub-system level. A sub-system or part design that is optimal from its local perspective may not be optimal from the global aircraft perspective. This design problem requires an optimization setup for consistent design evaluations on multiple levels.

REPORT NUMBER
NLR-TP-2017-370

AUTHOR(S)
W.F. Lammen
A.J. de Wit
W.J. Vankan
H.S. Timmermans
T. van der Laan
P.D. Ciampa

REPORT CLASSIFICATION
UNCLASSIFIED

DATE
April 2018

KNOWLEDGE AREA(S)
Aerospace Collaborative
Engineering and Design
Computational Mechanics
and Simulation Technology

DESCRIPTOR(S)
AGILE project
Collaborative design
multi-level optimization
aircraft rudder
surrogate model

Description of work

The EU Horizon 2020 project AGILE develops the next generation of Multidisciplinary Design and Optimization (MDO) methods, which target reduced development costs and time to market, leading to cost-effective and greener aircraft solutions. The methods involve the application of multi-partner analysis competences - using commercial and in-house developed software - for establishing designs collaboratively.

Within AGILE a multi-level optimization (MLO) approach has been applied to a component-airframe design problem of an aircraft rudder. First the MLO method Analytical Target Cascading (ATC) was applied to a theoretical example of fictive rudder design. Second a surrogate-based MLO approach was applied to a collaborative aircraft rudder design study involving multi-partner analysis tools.

Results and conclusions

The ATC method minimizes the design iterations between OEM and supplier and therefore it increases the efficiency of the collaborative process. Nevertheless ATC may not always be practical, e.g. if it is not possible to vary the coupling variables within the local optimization due to tool restrictions. In this case the variation of coupling variables can be facilitated by deriving a surrogate model that predicts local optima, as featured by second method.

Both methods illustrate that applying MLO provides insight into the aircraft rudder design problem both for the OEM and for the supplier and reduces development time.

Applicability

MLO methods can assist the OEM and suppliers - including the Dutch aircraft industry - to perform efficient collaborative design and constitute a competitive supply chain. In addition the surrogate models that are part of the second method could be used to protect the intellectual property (IP) of both OEM and supplier. This would allow for a better collaboration in situations where contracts have not been signed and IP issues can be sensitive.

GENERAL NOTE

This report is based on a presentation held at the CEAS conference, Bucharest, 18 October 2017.

NLR

Anthony Fokkerweg 2
1059 CM Amsterdam

p) +31 88 511 3113 f) +31 88 511 3210

e) info@nlr.nl i) www.nlr.nl



Dedicated to innovation in aerospace

NLR-TP-2017-370 | April 2018

Collaborative Design of Aircraft Systems - Multi-Level Optimization of an Aircraft Rudder

CUSTOMER: European Commission

AUTHOR(S):

W.F. Lammen

A.J. de Wit

W.J. Vankan

H.S. Timmermans

T. van der Laan

P.D. Ciampa

NLR- Netherlands Aerospace Centre

NLR- Netherlands Aerospace Centre

NLR- Netherlands Aerospace Centre

NLR- Netherlands Aerospace Centre

GKN Fokker Aerostructures

DLR, German Aerospace Center

This report is based on a presentation held at the CEAS conference, Bucharest, 18 October 2017.

*The contents of this report may be cited on condition that full credit is given to NLR and the authors.
This publication has been refereed by the Advisory Committee AEROSPACE VEHICLES (AV).*

CUSTOMER	European Commission
CONTRACT NUMBER	EC Grant agreement no. 636201
OWNER	NLR + partner(s)
DIVISION NLR	Aerospace Vehicles
DISTRIBUTION	Unlimited
CLASSIFICATION OF TITLE	UNCLASSIFIED

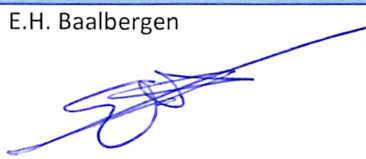
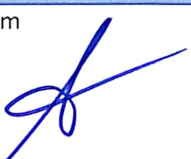
APPROVED BY :																				
AUTHOR				REVIEWER				MANAGING DEPARTMENT												
W.F. Lammen 				E.H. Baalbergen 				A.A. ten Dam 												
DATE	2	3	0	4	1	8	DATE	2	3	0	4	1	8	DATE	2	3	0	4	1	8

Contents

Collaborative Design of Aircraft Systems - Multi-Level Optimization of an Aircraft Rudder	1
ABSTRACT	1
NOMENCLATURE	2
1 Introduction	2
2 project context and problem formulation	3
3 MLO approach based on Analytical Target Cascading	5
4 Surrogate-based MLO with aircraft and rudder design tools	8
5 Conclusions	15
ACKNOWLEDGEMENTS	15
REFERENCES	15

This page is intentionally left blank.

Collaborative Design of Aircraft Systems - Multi-Level Optimization of an Aircraft Rudder

Wim Lammen

*NLR - Netherlands Aerospace Centre
R&D Engineer Modelling and Simulation
P.O.Box 90502, 1006 BM Amsterdam, The Netherlands
Wim.Lammen@nlr.nl*

Bert de Wit

*NLR - Netherlands Aerospace Centre
R&D Engineer Multidisciplinary Design and Optimization*

Jos Vankan

*NLR - Netherlands Aerospace Centre
Senior Scientist Multidisciplinary Design and Optimization*

Huub Timmermans

*NLR - Netherlands Aerospace Centre
R&D Engineer Aeroelasticity and Loads*

Ton van der Laan

*GKN Fokker Aerostructures
Knowledge Based Engineering Specialist
PO Box 1, 3350 AA Papendrecht, The Netherlands*

Pier Davide Ciampa

*DLR - German Aerospace Center
Research associate & Team lead Multidisciplinary Design and Optimization group
Hein-Saß-Weg 22, 21129, Hamburg, Germany*

ABSTRACT

The design and development of modern aircraft is a complex process involving many actors from different companies, e.g. the aircraft Original Equipment Manufacturer (OEM) and suppliers of (sub)systems and parts. The suppliers are responsible for their own system or part design, while the OEM is responsible for the overall aircraft design and the interfaces between the aircraft systems and parts. A system design that is optimal from system or part perspective may not be optimal from the global aircraft perspective. In order to avoid costly redesign iterations there is a need to optimize both the design of the overall aircraft and of its systems in an integrated way. This paper describes two methods for applying Multi-Level Optimization (MLO), in order to integrate the local system/part design optimization within the global aircraft design optimization. The design of an aircraft rudder is applied as use case. The use case addresses the coupling of a specific aircraft design analysis with a specific rudder design analysis and the global and local optimizations. First the MLO method Analytical Target Cascading (ATC) is applied to a theoretical example of fictive rudder design. Second a surrogate-based MLO approach is applied to a collaborative aircraft rudder design study involving multi-partner analysis tools. Both methods illustrate that applying MLO provides insight into the coupled design problem both for the OEM and for the supplier and reduces development time.

KEYWORDS: *multi-level optimization, collaborative design, aircraft rudder, surrogate models.*

NOMENCLATURE

Latin:

C - Consistencies
 R - Responses
 T - Targets
 b - Aircraft wing span
 f - Global objective function
 g - Constraint function
 h - Local objective function
 th - Rudder skin thickness
 ν - Lagrange multipliers
 w - Penalty parameters

Greek

τ - Consistency change tolerance
 π - Penalty function

Subscripts

m_{rud} - Rudder mass
 C_{rud} - Rudder chord
 F_{rud} - Rudder force
 m_{fuel} - Aircraft fuel mass
 m_{VTP} - Vertical Tail Plane mass
 w_i - Weight parameter in objective function
 τ_{ATC} - Objective change tolerance

1 INTRODUCTION

Over the past century, aircraft design and development has evolved from pioneering – one or few people building a simple and small aircraft in a shed – into a highly complex but well-established engineering process. Today, aircraft are highly advanced technological and competitive products that are developed by many multi-disciplinary teams of experts from different companies, often located in several countries. Besides the aircraft integration and final assembly by the Original Equipment Manufacturer (OEM), many sub-systems and parts of the aircraft are developed by tier 1 and 2 suppliers. The suppliers are responsible for their own part or system design, while the OEM is responsible for the overall aircraft design and the interfaces between the aircraft systems/parts. The suppliers have an important role, as they develop critical aircraft systems or parts, such as the engine or parts of the primary structure.

The *tier 1* suppliers deliver directly to the aircraft manufacturer. The tier 1 suppliers may be dependent on tier 2 suppliers that deliver specific subparts to them (and so on). Together these suppliers form the aircraft supply chain. Tier 1 suppliers often share responsibility and investment risk with the OEM for the delivery of a successful aircraft. This increases the need for a collaborative design approach. In order to be successful the suppliers must be able to access, operate at and contribute to aircraft-level analysis and optimization. At the same time, the specific disciplinary expertise need to be accessible by the aircraft integrator, which could make early use of these expertise to perform the analysis in support of the overall architecture evaluation.

Efficient collaboration among the aircraft development supply chain is considered important for developing an aircraft today and it will be even more in the future. It is needed to join the power of multiple experts and disciplines in aircraft development, to face the design challenges and apply disruptive technologies and unconventional solutions, in order to develop sustainable and successful aircraft. Furthermore, to respond to a dynamic market and to stay competitive it is necessary to shorten aircraft development lead times and to reduce cost.

As part of the aircraft collaborative design approach specific Multidisciplinary Design and Optimization (MDO) techniques have been investigated in the past decades (e.g. [1] [2]) that contribute to an improvement of the design process. Examples of such techniques are:

- Multi-Objective Optimization, for potential conflicting design objectives.
- Robust Optimization, for margins around the optimal design values, taking into account uncertainty.
- Surrogate modelling, for replacing complex design models by more efficient/ cheaper models in order to speed up optimization processes and facilitate collaborative and integrated design.
- Multi-Level Optimization, in order to decompose a complex design/optimization problem into multiple sub-problems, taking into account system hierarchy of an aircraft and the interaction between the suppliers and the OEM.

This paper focuses on Multi-Level Optimization (MLO). A system or part design that is optimal from its local perspective may not be optimal from the global aircraft perspective. In order to avoid costly redesign iterations there is a need to optimize both the design of the global aircraft and of its (local)

systems and parts in an integrated way. The integrated optimization may be constrained by the different design and analysis tools that the suppliers and OEM use. For example, tools may not interface with each other. Furthermore, a large number of communication events between OEM and suppliers – e.g. exchanging design variables after each design evaluation - may not be feasible, e.g. from cost or organizational perspective. Therefore, efficient optimization methods need to be applied that minimise the number of required communication events between the parties.

To investigate the MLO methodology we consider a use case of an aircraft rudder design as part of an aircraft preliminary design case. This use case addresses the coupling of a specific aircraft design analysis with a specific rudder design analysis and the corresponding global and local level optimizations.

The paper is organised as follows:

- Section 2 describes the context of the work as performed in the EU H2020 project AGILE [3] and formulates the design optimization problem.
- Section 3 details an MLO method using Analytical Target Cascading (ATC), based on literature and illustrates it with a theoretical example of (fictive) rudder design.
- Section 4 applies another MLO method based on surrogate modelling to an example of integrated rudder design, using the analysis tools and data as available in AGILE.
- Section 5 presents the main conclusions.

2 PROJECT CONTEXT AND PROBLEM FORMULATION

AGILE (“Aircraft 3rd Generation MDO for Innovative Collaboration of Heterogeneous Teams of Experts”, see [3] and [4]) is a European research project in the frame of the Horizon 2020 program. The high level objective of AGILE is to obtain a significant reduction in development time and costs of aircraft through the implementation of a more competitive supply chain at the early stages of the design. AGILE targets at multidisciplinary optimization using distributed analysis frameworks. The project is set up to proof a speed-up of 40% for solving realistic MDO problems compared to today’s state-of-the-art. AGILE considers various use cases on realistic preliminary aircraft design for both conventional configurations and some unconventional configurations (strut-braced wing, box-wing and blended-wing). The focus of AGILE is on the development of advanced optimization technologies, technologies for collaboration and knowledge-enabled information technologies. The optimization technologies that are investigated in AGILE include robust optimization, surrogate based optimization, multi-objective optimization and multi-level optimization (MLO).

MLO technologies are considered to address the coupled problem of design optimization on aircraft level as well as on component level. This coupled problem includes the setup of aircraft design and analysis processes on multiple levels to enable consistent design evaluations. Moreover, multiple objectives and constraints e.g. for cost analyses or robust design on the aircraft and component levels may be included. Another challenge for the MLO technologies is the multi-partner collaboration between aircraft OEM and suppliers. Therefore AGILE also investigates collaborative multi-partner simulation infrastructures for various design tools, based on commercial and in-house developed software.

A MLO test case for integrated Component-Airframe design optimization has been defined by the industrial AGILE partner Fokker, who is a supplier of aircraft structural components and movables to aircraft OEMs. Therefore the design and optimization of an aircraft rudder has been identified. The aircraft rudder design is based, among others, on the rudder planform specifications (e.g. rudder chord, span, outer mold line) and the applicable rudder loads (e.g. rudder aerodynamic forces, hinge forces, actuator forces), both provided by the aircraft OEM. The rudder loads follow from the prescribed certification load cases (see [5]). For instance, critical load cases for the rudder are the cases “Flying with one engine inoperative”¹. In those cases the rudder needs to be able to compensate the yaw moment of the aircraft that is caused by flying on one engine only. On the level of the rudder design, the rudder structures shall be optimized for weight and cost, e.g. under the constraints that the requirements on specifications and loads are fulfilled. On the level of the aircraft design, the whole aircraft structure would be optimized, e.g. for weight and drag, using the main wing planform parameters as design variables.

¹ Assume the aircraft has one engine mounted under the wing.

In the present study we consider a simplified version of the above mentioned MLO use case for design and optimization of an aircraft rudder. For the variation in the aircraft level design we only consider the main wing span as design variable. For the one-engine-inoperative load cases, an increase in wing span (assuming constant relative span-wise position of the engine) would have a direct effect on the applicable rudder force due to the larger yaw moment. On the level of the rudder design, the rudder structure shall be optimized for the applicable force (representing the loads). Furthermore, the rudder planform may need to be changed if the rudder deflection angle reaches its maximum when compensating the aircraft yaw moment. On its turn, a change in rudder design may impact the aircraft design, e.g. a change in rudder weight does also affect the overall aircraft weight and balance. This interaction is illustrated in Figure 1 below.

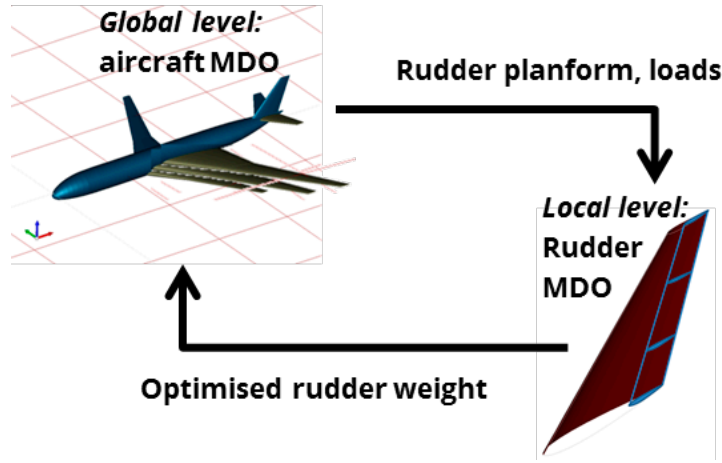

Figure 1: Global and local levels in aircraft and rudder design.

Mathematically, the aircraft rudder MLO use case can be formulated as follows. For simplification the number of design variables is kept to a minimum. Assume that $f(b, m_{rud})$ is some global aircraft optimization objective that depends on the global design variable wing span b and – in some way – on the rudder mass m_{rud} . The objective function f could be based e.g. on aircraft total weight, fuel burn or range. Assume that the rudder mass depends on the rudder planform, represented via rudder span (fixed) and rudder chord (design variable). Furthermore, rudder mass depends on the (resulting) rudder force (representing the loads) for which it has been designed:

$$m_{rud} = m_{rud}(c_{rud}, F_{rud}) \tag{1}$$

With rudder chord c_{rud} and rudder force $F_{rud} = F_{rud}(c_{rud}, b)$, assuming that the rudder force depends both on the rudder chord (representing the rudder planform) and the wing span (as explained earlier). Then the global a/c level optimization problem is formulated as follows:

$$\begin{aligned} \min_{b, c_{rud}} \quad & f(b, m_{rud}(c_{rud}, F_{rud}(c_{rud}, b))) \\ \text{subject to:} \quad & g(b, c_{rud}) \leq 0 \\ \text{bounded by:} \quad & \underline{b}, \underline{c_{rud}} \leq b, c_{rud} \leq \overline{b}, \overline{c_{rud}} \end{aligned} \tag{2}$$

With g a (nonlinear) constraint function that could be based on the maximum rudder deflection in combination with the applicable load case. On its turn function m_{rud} could be defined by the optimized rudder mass, as calculated by the rudder supplier:

$$m_{rud}(c_{rud}, F_{rud}) = \min_{th} h(th, c_{rud}, F_{rud}) \tag{3}$$

The function h is the local rudder level objective function. In this case h represents the output of the rudder design tool calculation at the supplier. The local design variable th represents the rudder skin thickness. Several other local design variables, e.g. number of ribs or hinges could be considered as well, but are left out here, for simplicity. The parameters c_{rud} and F_{rud} are either constant parameters for the local objective function h - as formulated above - or could be part of local constraint functions, depending on the implementation of the local rudder design and optimization tools.

The optimization problem formulation described above is based on a 'nested' approach, because the local level optimization is embedded in the global level optimization. In the next section the

optimization is split over two separate levels while so-called coupling variables are exchanged to allow communications between global a/c level and the local rudder level optimizations.

3 MLO APPROACH BASED ON ANALYTICAL TARGET CASCADING

Various approaches can be followed to deal with the aircraft rudder MLO use case. In the past decades, many methodologies have been investigated for MLO approaches in engineering problems. For example, overviews can be found in the PhD dissertation of De Wit [6], the survey of Martins and Lambe [1] and the overview of Balling and Sobieski [7].

In essence, an MLO problem consists of a hierarchy of individual but coupled optimization problems. In contrast, in traditional ("single-level") optimization the hierarchical ("multi-level") nature of the underlying design problem is not explicitly accounted for in the optimization problem formulation.

MLO approaches typically consist of four sequential steps. First, a hierarchy is identified in the considered system and/or design problem. Second, a decomposition (splitting) technique has to be defined based on the coupling characteristics. Third, a coordination strategy is defined. This involves setting up a procedure (i.e. define the rules) for communication between the decomposed but coupled sub problems. Finally, a job scheduling procedure is defined to have the sub problems communicate in the right sequence and corresponding to the computer architecture (e.g. sequential, parallel, or distributed).

A hierarchy can be naturally present in the process flow, e.g. along disciplines, departments or subcontractors that are involved in the design process. A hierarchy may also be introduced via e.g. a problem matrix [8] (also known as Functional Dependence Table [9]). In the present study of the aircraft rudder MLO use case the hierarchy is identified along the current process flow, in accordance with the hierarchy of the considered systems. An airframer designs an overall aircraft and subcontracts the rudder design. At (global) aircraft level design variables are set, e.g. wing span. At local level the rudder design variables are set, e.g. based on planform specifications, applied forces, manufacturing costs and available manufacturing material. Figure 1 shows the levels present in the current design case.

The optimization problem for the aircraft rudder MLO use case, as formulated in the previous section, has been decomposed following the MLO approach of Analytical Target Cascading (ATC) [10]. Decomposition of the design problem is accomplished via temporarily decoupling the interaction between the coupled (sub)systems, i.e. the aircraft and the rudder. The coupling itself is enforced by constraints. In Figure 2 coupling variables have been introduced between the rudder and aircraft analysis: rudder force, rudder chord and rudder mass. For each coupling variable a value is calculated by the decoupled Aircraft level analysis, called the *Target* (T), and by the decoupled Rudder level analysis, called the *Response* (R). Constraints have been introduced to maintain *Consistency* (C) between the targets and the responses.

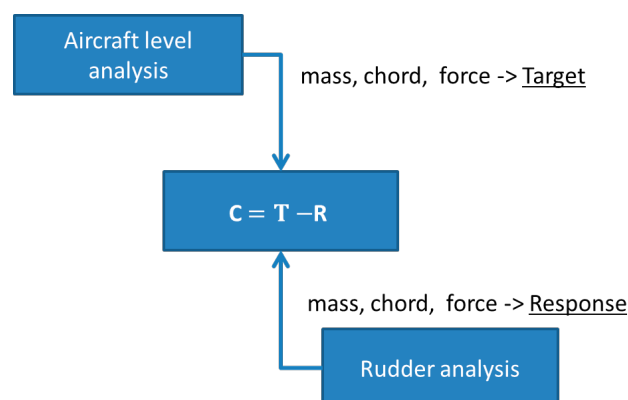

Figure 2: Introducing consistency constraints according to the ATC approach in a coupled MLO problem.

The constraints can be maintained on the global level, the local level, or both. In our case the constraints are applied to both the global level optimization and the local level optimization. Figure 3 depicts the decomposed optimization problem with the coupling constraints (both on global and local level).

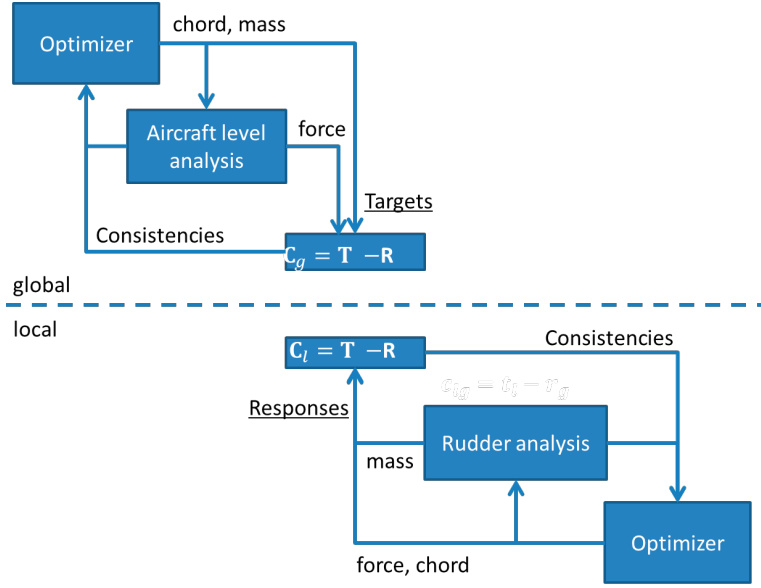

Figure 3: Decoupled aircraft level and rudder level optimization in ATC based MLO.

The consistency constraints are relaxed via a so-called Augmented Lagrangian Penalty function [10] (expressed as a function of the consistency: $\pi(\mathbf{C})$ in Eq. 4 below). This is a so-called *weak* coupling approach in which the consistency constraints ($\mathbf{C} = 0$) are relaxed via:

$$\pi(\mathbf{C}) = \mathbf{v}^T \mathbf{C} + \|\mathbf{w} \circ \mathbf{C}\|_2^2 \quad (4)$$

The \circ symbol is used to denote a term-by-term multiplication of vectors. Two additional parameters are applied to derive a penalty function of the consistency violations: the Lagrange multipliers \mathbf{v} and the penalty parameters \mathbf{w} . To determine values for these parameters a coordination strategy is necessary. To achieve convergence of the relaxed problem, the Lagrange multipliers are updated via:

$$\mathbf{v}^{k+1} = \mathbf{v}^k + 2\mathbf{w}^k \circ \mathbf{w}^k \circ \mathbf{C}^k \quad (5)$$

and the penalty parameters by:

$$\mathbf{w}^{k+1} = \beta \mathbf{w}^k \quad (6)$$

where $\beta \geq 1$, typically chosen between 2 and 3, see [10]. The k stands for the iteration number of updating the penalty parameters. These parameters are updated until the change in objective function values (f) of global and local system has become sufficiently small (expressed by threshold τ_{ATC}):

$$\|(f_g + f_l)^k - (f_g + f_l)^{k-1}\|_{inf} \leq \tau_{ATC} \quad (7)$$

The entire optimization process is finished when in addition to the change in objective function values the change in consistency has become sufficiently small. This is mathematically expressed as:

$$\|\mathbf{C}^k - \mathbf{C}^{k-1}\|_{inf} \leq \tau \quad (8)$$

Typically, τ_{ATC} is chosen as:

$$\tau_{ATC} = \frac{\tau}{10}. \quad (9)$$

Finally, a job scheduling procedure is defined. Here, a sequential solution process is chosen. First the global optimization problem is solved (with initial response values). Second, the targets from the global system are communicated to the local system and the local system is optimized, see the inner loops of Figure 4. Third, a check for updating the Lagrange multipliers and penalty parameters is done, see the outer loop of Figure 4. The responses from local level are communicated to the global system. This procedure is then repeated until the change in consistencies \mathbf{C} has become sufficiently small, see Eq. 8.

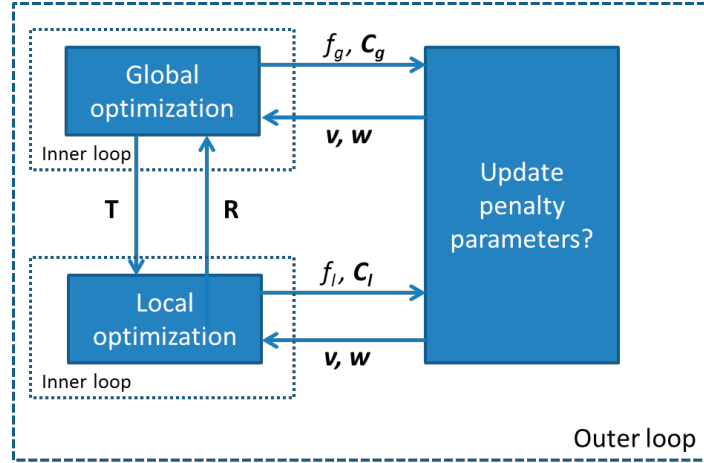

Figure 4: Sequential update process of the subsystems optimizations.

Applying the ATC approach (as described above) to Eq. 2 results in the following problem decomposition. The global optimization problem is expressed as:

$$\begin{aligned} \min_{b, \mathbf{T}} \quad & f(b, \mathbf{T}) + \pi(\mathbf{C}_g) \\ \text{bounded by:} \quad & \underline{b}, \underline{\mathbf{T}}_g \leq b, \mathbf{T} \leq \bar{b}, \bar{\mathbf{T}} \end{aligned} \quad (10)$$

The local optimization problem is expressed as:

$$\begin{aligned} \min_{th, \mathbf{R}} \quad & h(th, \mathbf{R}) + \pi(\mathbf{C}_l) \\ \text{subject to:} \quad & g(th, \mathbf{R}) \leq 0 \\ \text{bounded by:} \quad & \underline{th}, \underline{\mathbf{R}} \leq th, \mathbf{R} \leq \bar{th}, \bar{\mathbf{R}} \end{aligned} \quad (11)$$

With b the wing span, \mathbf{T} the target values of the coupling variables (rudder chord, rudder mass and rudder force), \mathbf{R} the responses of the coupling variables, th the rudder skin thickness, \mathbf{C}_g and \mathbf{C}_l the consistencies on global and local level and π the penalty function as described above, and f and h the global and local objective functions. In contrast to Eq. 2 the constraint function g is now defined on the local level. The functions f , g , and h have been represented by the fictive formulas:

$$f(b, \mathbf{T}) = -(b^2 + 2 * c_{rud}^2 - 17.5 * m_{rud} + 4000) \quad (12)$$

$$g(th, \mathbf{R}) = \frac{F_{rud}}{1000 * th} - th^2 \quad (13)$$

$$h(th, \mathbf{R}) = \left(\frac{F_{rud} * th}{4000} \right)^2 + c_{rud}^3 * th^2 + 3 * c_{rud} \quad (14)$$

Furthermore, a fictive rudder force calculation is used: $F_{rud} = 400 * (b + c_{rud})$. The global and local optimization problems have been implemented in MATLAB and solved as outlined previously. Both the global and local optimizations have been performed with a sequential quadratic programming (SQP) method, using finite difference approximation of the derivatives. The results are illustrated in Figure 5 and Figure 6 below, showing the iteration history of the outer loop. Figure 5 depicts the iteration history of the coupling variables: rudder mass, rudder force and rudder chord. The initial differences between the targets and responses are large. The augmented Lagrangian penalty function pushes each subsystem to move the target values and response values closer to an agreement. After 15 cycles consistency is sufficient and a corresponding optimum solution for global and local objective function has been found. Figure 6 shows the corresponding iteration history of the global and local design variables, and the global objective.

From this MLO exercise it can be seen that individual optimizations on local and global level may provide conflicting design results. A strategy, such as ATC is needed that integrates both optimizations and synchronizes the results, taking into account the mutual interdependencies. Due to the division in inner and outer loops the number of exchanges between global and local level is smaller than if a nested approach or all-in-one (see [10]) approach would be applied. In the latter

two cases the exchanges take place each time the global objective function is evaluated. When solving the optimization problem described above all-in-one 40 iterations² were needed.

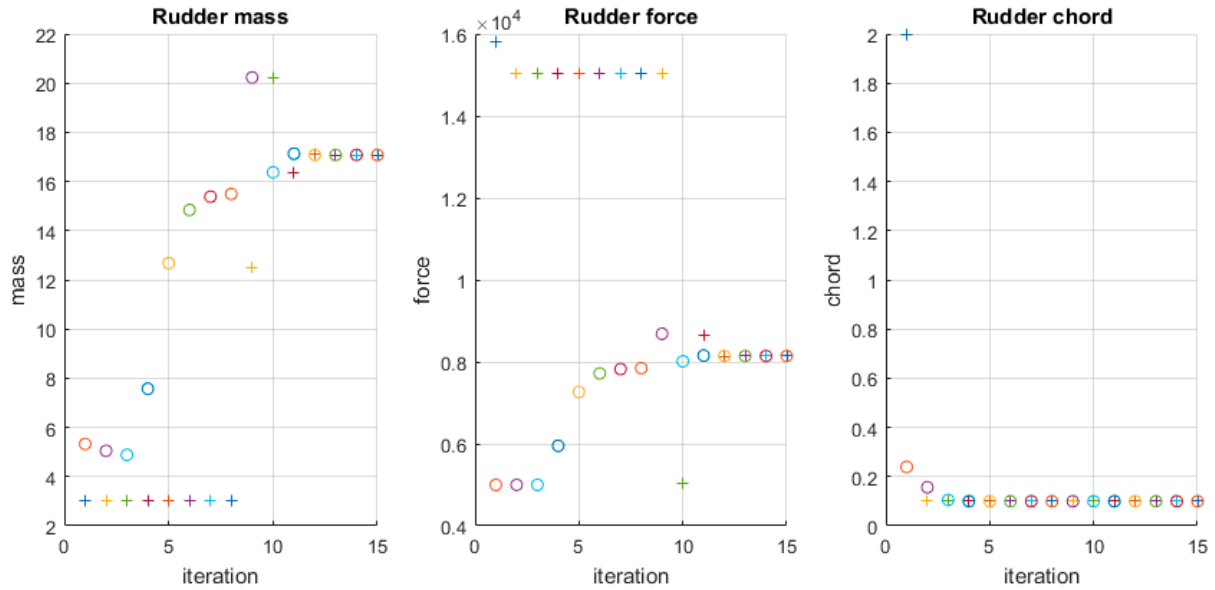

Figure 5: MLO outer loop iterations of coupling variables. The + signs represent the globally optimized values (targets). The o signs represent the locally optimized values (responses).

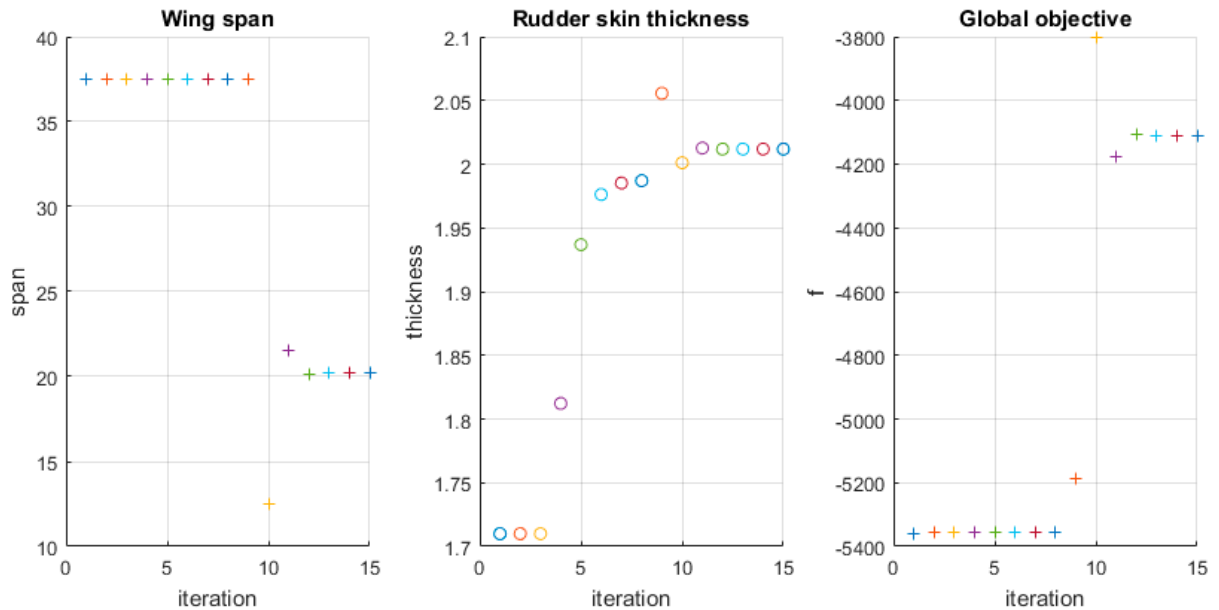

Figure 6: MLO outer loop iterations of design variables and objective. The + signs represent the global level. The o signs represent the local level.

4 SURROGATE-BASED MLO WITH AIRCRAFT AND RUDDER DESIGN TOOLS

The previous section explained the ATC method in the context of a theoretical example of the aircraft rudder MLO use case. The ATC method requires flexibility in the configuration of the optimizers and the underlying analysis tools, e.g. by allowing variation of the coupling variables both within the global and local optimizer. This flexibility might not always be feasible in practice e.g. due to restrictions of the analysis tools or optimization processes. Therefore, complementary to the previous method, this section describes the aircraft rudder MLO use case applying an alternative approach: by

² Optimality, constraint and step tolerances of 1.0e-6 have been applied as convergence criteria.

performing a nested MLO, accelerated by surrogate modelling. Moreover, the approach is applied to aircraft design and analysis tools that are used in the AGILE project.

4.1 Aircraft and Rudder design analysis tools

In the frame of the AGILE project, design analyses both on the aircraft level and on the rudder level have been performed with the following tools:

- Overall Aircraft Design (OAD) analysis capability, provided by DLR as a service. A multidisciplinary analysis (MDA) is performed, including full aircraft synthesis, tail plane resizing (e.g. following from the specified rudder mass), mass distribution and mission analysis. The OAD analysis is composed by distributed design competences available at DLR, for preliminary aircraft design activities. The competences included in the current study comprise both conceptual aircraft design methods [11], and physics based modules, such as aero-structural FEM based capabilities [12]. The OAD process is integrated as a fully automated multi-level workflow: in the global overall aircraft synthesis process it accounts for the input provided by the local level. The OAD analysis is used for calculation of the global design objective, e.g. fuel mass or tail mass. Aircraft wing MDO with varying wing span has been chosen as global-level design case.
- Aeroelastic Modelling and Loads (AMLoad) analysis tool [13], provided by NLR. AMLoad is used for calculation of the loads on and deflection of the rudder, for a given aircraft configuration that was processed by the OAD capability. A "one engine inoperative" load case has been chosen as it is assumed that this case provides the critical rudder loads. The rudder deflection is used for calculation of the global constraint function. The rudder loads (represented by rudder force) are provided to the rudder level.
- Hinge-System Design and Optimization Tool (HDOT) [14], provided by Fokker representing the rudder MDO. HDOT optimizes rudder hinge design with respect to mass.

Figure 7 depicts the workflow of the analysis tools, their interactions and the exchange of variables in the multi-level context.

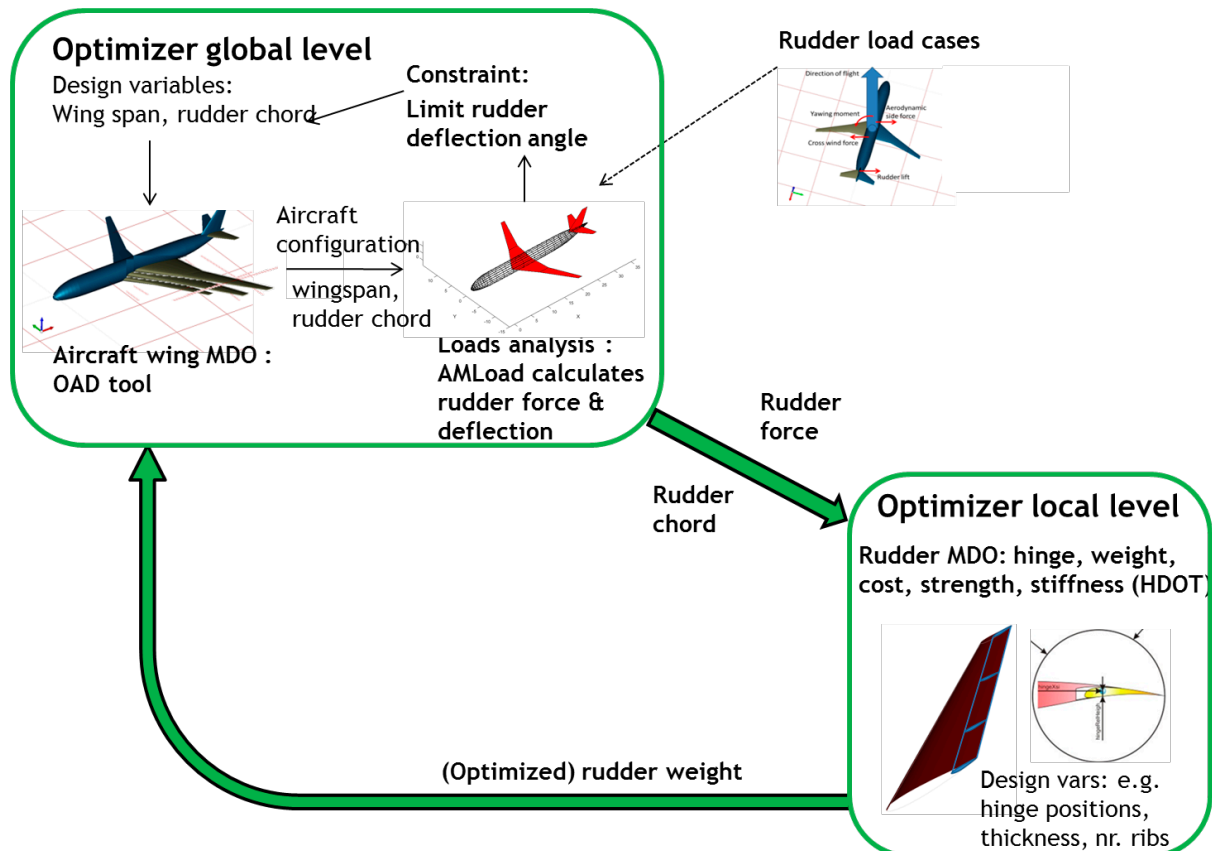

Figure 7: Workflow scheme of the aircraft rudder design tools in MLO context.

The workflow fits in with the multi-level formulations that were introduced in the previous sections. The OAD tool and AMLoad represent the global analysis tools, which are to be steered by a global optimizer. The HDOT represents the local level optimization. The rudder planform (here represented by rudder chord, for simplicity) and rudder force are specified as parameter values. However they are fixed during the local optimization process itself as a result of legacy choices during the development of the local HDOT tool. Therefore the decomposition based on ATC as explained in the previous section is difficult to apply to this case. Instead a surrogate model has been created that predicts the locally optimized rudder masses as function of rudder chord and force. A surrogate model is an analytical formula that replaces a complex model by means of data fitting, see [2] or [15]. Consequently a surrogate model requires only small computation time, which is particularly useful for capturing complex analysis methods (e.g. HDOT) and applying them multiple times as part of a global optimization. Similarly, surrogate models have been created of the global level analysis tools OAD and AMLoad. The surrogate models are detailed in the next subsection.

4.2 Surrogate models derived from the analysis tools.

A Design of Experiment (DoE), based on Latin Hypercube Sampling (LHS) has been created for analysing 30 aircraft configurations with the OAD capability. A constant wing area has been applied, while varying the wing span, the rudder root chord and the rudder mass. During the OAD simulations a fixed aircraft mission is applied. From the analysis of the resulting OAD simulation data relations have been found between the input parameters rudder mass and wing span and the output parameters fuel mass and Vertical Tail Plane (VTP) mass (with the rudder mass included). This relation is shown in Figure 8 below. The data has been fitted by polynomials, with relatively small values of the root mean squared error (RMSE) as evaluated on the fitting data set (see Figure 8).

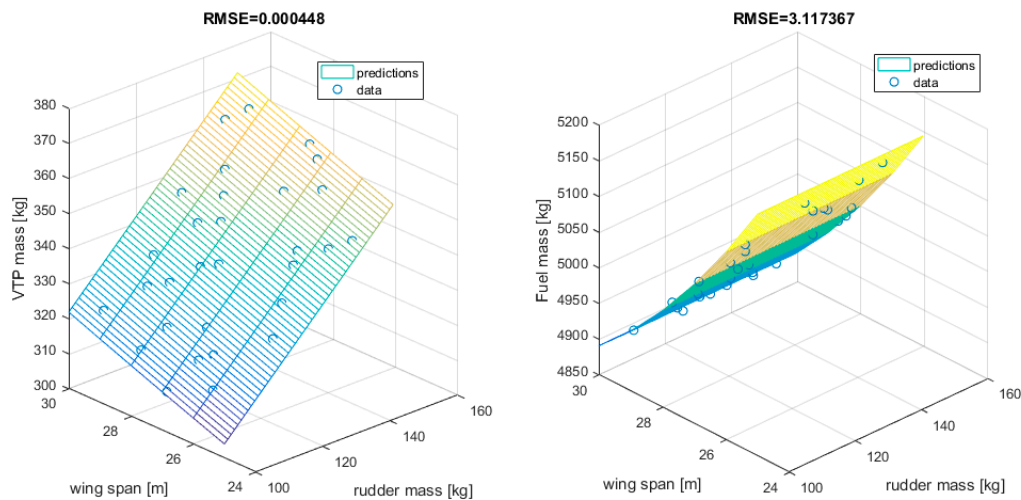

Figure 8: Surrogate model prediction of VTP mass (left) and fuel mass (right) derived from the OAD simulation data.

The OAD simulation data have been further processed by AMLoad in order to calculate the corresponding rudder loads and deflection for each aircraft configuration. From the AMLoad results relations have been derived between the rudder root chord, the wing span and the rudder lateral force, and between the rudder root chord, the wing span and the rudder deflection, see Figure 9. The latter relation is important for the optimization constraint that follows from the rudder load case: the rudder deflection has an upper limit. This means that if the deflection exceeds this limit a larger rudder e.g. a larger rudder chord is needed.

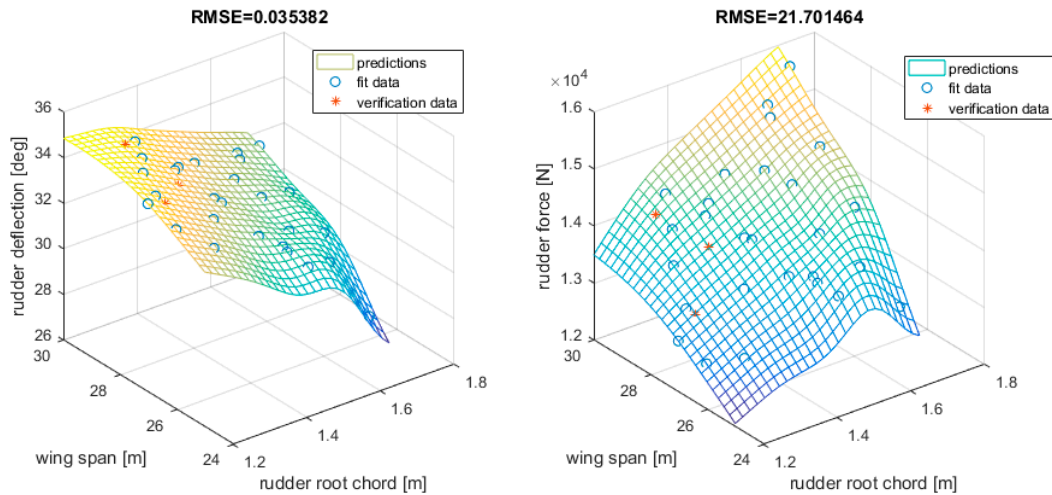

Figure 9: Surrogate model prediction of rudder deflection (left) and rudder load (right), derived from the AMLoad simulation data.

The data has been fitted by an interpolating kriging model with a 2nd order polynomial regression and Gaussian correlation function. Because the surrogate model is based on an interpolating function, its prediction has been verified by calculating the RMSE on randomly chosen verification data points which were excluded from the fitting data set (see red stars in Figure 9). This results in an RMSE that is three orders of magnitude smaller than the actual data. Additional verification has been performed with the leave-one-out method. With this method one data point is excluded from the fitting set and reserved for verification of the prediction. This exclusion data point then shifts over the complete data set, resulting in 30 fits (each time performed on the remainder of 29 data points) and 30 verifications. The RMSE values of these 30 verifications are about 0.14 deg and 60 N for the rudder deflection and rudder force predictions respectively. The fits and verifications have been derived using NLR's MATLAB-based tool MultiFit [2].

On the rudder level HDOT calculates the optimized mass of the rudder hinge assembly. Rudder loads (e.g. force) and rudder planforms (e.g. chord) can be provided as parameter values. Figure 10 shows the relation between the optimized rudder hinge mass and rudder lateral force, interpolated by piecewise polynomial functions. Data of the full rudder mass are not yet available. Therefore, in order to illustrate the method, the HDOT results have been scaled up to the level of the rudder mass using the rudder root chord, see Figure 11.

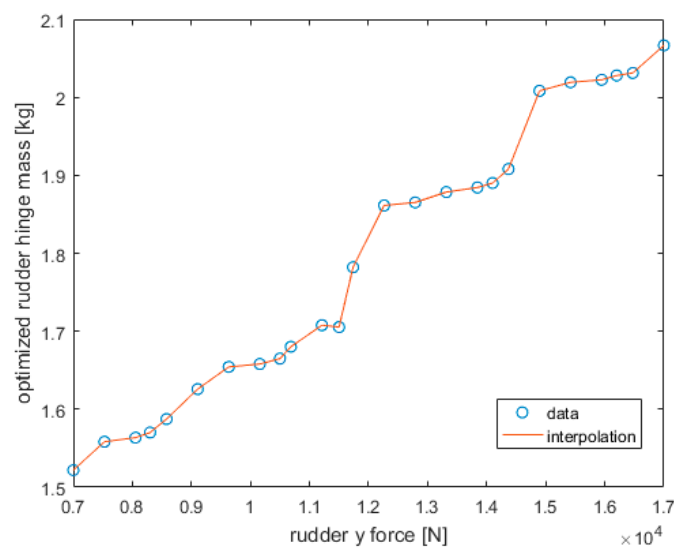

Figure 10: Surrogate model prediction of optimized rudder hinge mass, based on HDOT data.

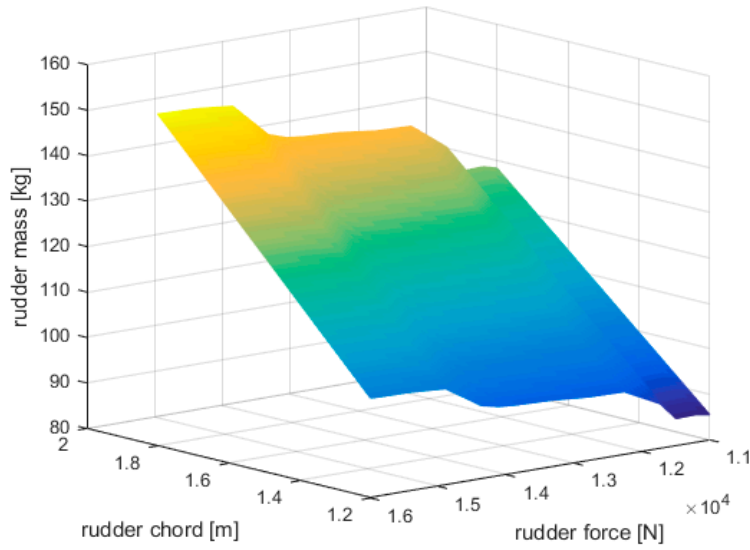

Figure 11: Prediction of optimized rudder mass, based on scaling of HDOT surrogate model.

4.3 Aircraft rudder MLO results with the surrogate models

The surrogate models described in the previous subsection have been integrated into an objective function for the integrated optimization problem. Figure 8 shows that the fuel mass depends on the wing span, but only slightly on the rudder mass. Instead the VTP mass depends³ both on the rudder mass and on the wing span. Therefore both fuel mass and VTP mass are taken into account in the global optimization. As objective function a weighted sum of the aircraft fuel mass [kg] and the vertical tail plane (including rudder) mass [kg] is used (with w_1 and w_2 the weight constants):

$$f_{obj} = w_1 * m_{VTP} + w_2 * m_{fuel} \quad (15)$$

The compound objective function $f_{obj} = f_{obj}(c_{rud}, b)$ is calculated by performing the following steps:

- Calculate the rudder force as function of rudder root chord c_{rud} and wing span b , using the AMLoad derived surrogate model, see Figure 9.
- Calculate the (locally) optimized rudder mass as function of the rudder force, using the HDOT derived surrogate model, see Figure 11.
- Calculate the fuel mass and VTP mass as function of optimized rudder mass and wing span, using the OAD derived surrogate model, see Figure 8.
- Calculate the weighted sum, see Eq. 15.

As a constraint a maximum rudder deflection of 32 degrees is applied. This limit is used as illustrative value as it fits in the range of calculated deflections, see Figure 9. Actual rudder deflection limits maybe different. The deflection is calculated as function of rudder root chord c_{rud} and wing span b by using the AMLoad derived surrogate model (see Figure 9). The optimization problem formulation in section 2 is translated as follows:

$$\begin{aligned} \min_{b, c_{rud}} \quad & w_1 * m_{VTP}(b, m_{rud}(c_{rud}, F_{rud}(c_{rud}, b))) + w_2 * m_{fuel}(b, m_{rud}(c_{rud}, F_{rud}(c_{rud}, b))) \\ \text{subject to:} \quad & defl_{rud}(b, c_{rud}) \leq 32 \end{aligned} \quad (16)$$

The optimization has been performed in MATLAB using a sequential quadratic programming (SQP) method. The optimization iterations are depicted in Figure 12. Different weight combinations (w_1, w_2) have been applied. It can be seen that a larger value of w_1 results in a lower VTP mass, but in a higher fuel mass. Furthermore, different numbers of iterations were needed to find the optimum.

³ Here only the mass dependencies are considered. In general the VTP design will be affected by the rudder design in several ways, e.g. by the hinge positions.

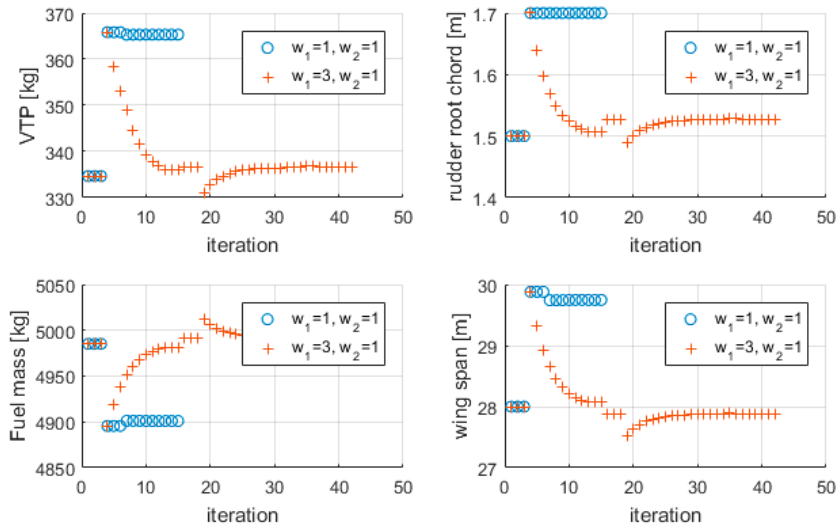

Figure 12: Optimization iterations (using SQP) with objectives (left) and design parameters (right) and two weighting combinations.

In addition, Table 1 shows the SQP optimization results with varying weight values w_1 from 1 to 8, while $w_2=1$. The optimized designs vary from a large wing span, resulting in a low fuel mass⁴, but with a relatively high VTP mass, to a small wing span resulting in a lower VTP mass. If the wing span increases, the rudder root chord increases as well. This is enforced by the optimization constraint function: a large wing span increases both the rudder force and deflection. If the deflection exceeds the deflection limit, the rudder chord needs to be enlarged, in order to enable the yaw moment compensation with a smaller rudder deflection.

Table 1: SQP optima, with varying weight value w_1 (with $w_2=1$).

Weight value w_1	rudder root chord [m]	wing span [m]	VTP mass [kg]	Fuel mass [kg]	weighted objective f_{obj}
1	1.7	29.7	365.3	4901.0	5266.3
2	1.7	29.7	365.3	4901.0	5631.6
3	1.5	27.9	336.5	4992.5	6002.0
4	1.5	27.8	335.1	4997.6	6338.1
5	1.5	27.6	332.5	5009.3	6672.0
6	1.4	26.3	318.4	5092.8	7003.0
7	1.4	26.0	315.3	5112.8	7319.9
8	1.3	25.0	305.1	5189.1	7629.7

In addition to representing the objective function by a weighted sum, also a multi-objective optimization approach has been applied. A genetic algorithm (GA), with a population size of 70 and 115 generations has been used to derive a Pareto optimal set for optimizing both fuel mass and VTP mass. The same constraint function and surrogate models as in Eq. 16 have been used. Particularly in case of applying global optimization with a genetic algorithm the use of surrogate models is advantageous because a very large amount of function evaluations is performed: about 8000 compared to order 10 to 100 evaluations with the SQP algorithm. The results are depicted in Figure 13. The circles represent the Pareto optimal set, the + represent the originally calculated OAD configurations that are feasible (based on the rudder deflection constraint), the x represent the configurations that are unfeasible and the stars represent the optima calculated before with the SQP method (see Table 1).

⁴ This is because the corresponding wing design has a high aspect ratio which increases aerodynamic efficiency.

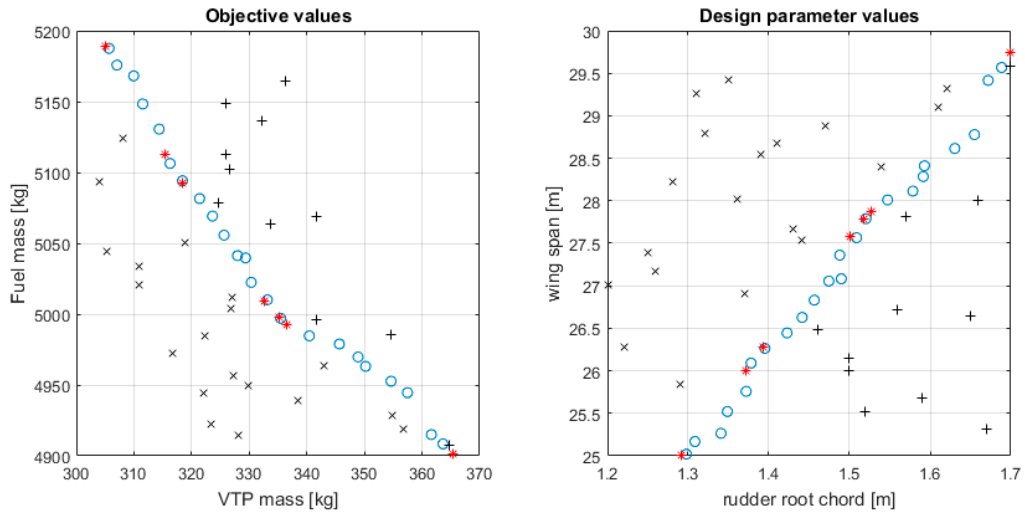

Figure 13: Pareto plots of the objectives (left) and design parameters (right).

Three calculated optima have been selected for verification afterwards by the OAD capability: the SQP optimized designs with weight parameter w_1 values 1,3 and 6 (see Table 1). The results of this verification are listed in Table 2. The surrogate model predictions - as calculated during SQP optimization - are very close to the corresponding OAD evaluations, which is in line with the low prediction errors as shown in Figure 8. In addition, the aircraft configurations that correspond with the three selected optima are visualised in Figure 14. In this visualisation the reference configuration of the OAD capability is included as well. The reference aircraft configuration has a wing span of 27.18 m and a rudder root chord of 1.47 m.

Table 2: OAD evaluation of selected SQP optimization results.

rudder root chord [m]	wing span [m]	VTP mass [kg] (surrogate prediction)	VTP mass [kg] (OAD calculation)	Fuel mass [kg] (surrogate prediction)	Fuel mass [kg] (OAD calculation)
1.4	26.3	318.4	318.3721	5092.8	5093.0
1.5	27.9	336.5	336.4851	4992.5	4994.0
1.7	29.7	365.3	365.328	4901.0	4901.0

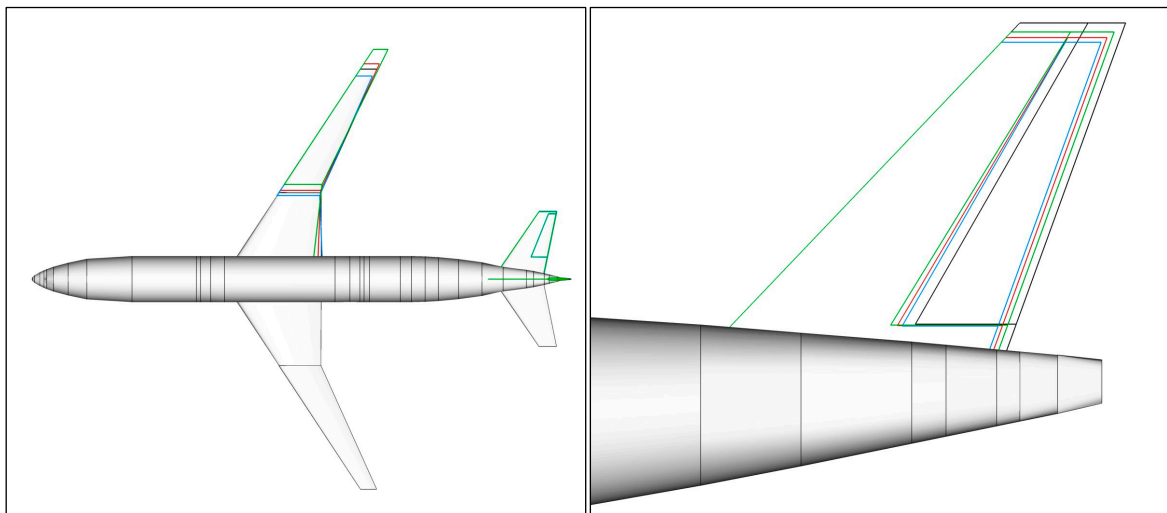

Figure 14: Wing planform (left) and VTP (right) comparisons of optimal designs: 1-blue, 2-red, 3-green (with increasing wing span) versus the baseline configuration (black).

5 CONCLUSIONS

Two methods for Multi-Level Optimization (MLO) have been described in the context of aircraft rudder design. The (first) ATC method applies MLO by decoupling the optimization problem into an aircraft (global) level optimization problem and rudder (local) level optimization problem. Both problems are solved separately, while enforcing the couplings by constraints. The level of consistency is checked after each global and local optimization in an iterative process. In this way the number of communication events between the global and the local level becomes smaller than if the local optimization is part of the global objective function (which is the case with a nested MLO). Limiting the number of communication events is needed in order to derive an efficient collaboration between the aircraft OEM (performing the global optimization) and the supplier (performing the local optimization).

Nevertheless ATC may not always be practical, e.g. if it is not possible to vary the coupling variables within the local optimization due to tool restrictions. In this case the variation of coupling variables can be facilitated by deriving a surrogate model that predicts local optima. This approach has been applied with the second method: nested MLO with surrogate models. An aircraft rudder MLO has been performed in which the locally optimized rudder mass is predicted by a surrogate model and integrated into the aircraft (global) level objective function. The surrogate model provides flexibility to the aircraft OEM, e.g. when performing conceptual design. Moreover, surrogate models of the aircraft level analyses have been created as well, to make the global optimization process even more efficient.

The two methods have been illustrated with different implementations of the aircraft rudder MLO use case. The ATC method has been applied to example analytical functions based on a fictive rudder design. The surrogate-based MLO method has been applied to an example of integrated rudder design, using the analysis tools and data as available in the AGILE project. Both methods illustrate that applying MLO provides insight into the coupled aircraft rudder design problem both for the OEM and for the supplier and reduces development time.

ACKNOWLEDGEMENTS

The research presented in this paper has been performed in the framework of the AGILE project (Aircraft 3rd Generation MDO for Innovative Collaboration of Heterogeneous Teams of Experts) and has received funding from the European Union Horizon 2020 Programme (H2020-MG-2014-2015) under grant agreement n° 636202. The authors are grateful to the partners of the AGILE Consortium for their contribution and feedback.

REFERENCES

1. J. Martins and A. Lambe; 2013; "Multidisciplinary design optimization: A survey of architectures"; *AIAA Journal*, **51** (No. 9); pp. 2049-2075.
2. W.J. Vankan, W.F. Lammen and R. Maas; 2010; "Meta-modeling and multi-objective optimization in aircraft Design"; Editors E. Kessler, and M.D. Guenov; *Advances in collaborative civil aeronautical multidisciplinary design optimization. Progress in Astronautics and Aeronautics*; **233**; American Institute of Aeronautics and Astronautics, Reston, VA; chapter 6.
3. AGILE website; 2017; <http://www.agile-project.eu/>.
4. P.D. Ciampa, B. Nagel; 2017; "The AGILE Paradigm: the next generation of collaborative MDO,"; *18th AIAA/ISSMO Multidisciplinary Analysis and Optimization Conference*, Denver; AIAA 2017-4137.
5. FAR Part 25 Section 25.147; 2017; <http://www.far.gov>.
6. A.J. de Wit; 2009; "A Unified Approach towards Decomposition and Coordination for Multi-level Optimization"; *PhD thesis*; Delft University of Technology.
7. R. Balling and J. Sobieszcanski-Sobieski; 1996; "Optimization of coupled systems: A critical overview of approaches"; *AIAA Journal*; **34** (1); pp. 6 - 17.
8. J.F. Barthelemy; 1989; "Engineering design applications of multilevel optimization methods."; Editors C. Brebbia and S. Hernandez; *Computer Aided Optimum Design of Structures: Applications*; Springer-Verlag; pp 113 - 122.

9. T. Wagner; 1993; "A general decomposition methodology for optimal system design"; *PhD thesis*; The University of Michigan.
10. S. Tosserams, L. Etman, P. Papalambros, and J. Rooda; 2006; "An augmented lagrangian relaxation for analytical target cascading"; *Structural and Multidisciplinary Optimization*; **31** (3); pp. 176 - 189.
11. D. Böhnke, B. Nagel and V. Gollnick; 2011; "An Approach to Multi-Fidelity in Conceptual Aircraft Design in Distributed Design Environments"; *32nd IEEE Aerospace Conference, Big Sky*.
12. P. D. Ciampa, T. Zill and B. Nagel; 2013; "A hierarchical aeroelastic engine for the preliminary design and optimization of the flexible aircraft"; *54th AIAA/ASME/ASCE/AHS/ASC Structures, Structural Dynamics, and Materials Conference*, Boston, AIAA 2013-1820.
13. H. Timmermans and B. Prananta; 2016; "Aeroelastic Challenges in the Aircraft Design Process"; *READ & SCAD conference*; Warsaw; September 2016.
14. A. Kulkarni, R. van Dijk, T. van den Berg and G. La Rocca; 2017; "A Knowledge based engineering tool to support front-loading and multi-disciplinary design optimization of the fin-rudder interface"; *Aerospace EUrope 6th CEAS Conference*, Bucharest.
15. W. Lammen, P. Kupijai, D. Kickenweitz, T. Laudan; 2014; "Integrate engine manufacturer's knowledge into the preliminary aircraft sizing process"; *Aircraft Engineering and Aerospace Technology: An International Journal*; **86** (4); pp. 336 - 344.

NLR

Anthony Fokkerweg 2

1059 CM Amsterdam, The Netherlands

p) +31 88 511 3113 f) +31 88 511 3210

e) info@nlr.nl i) www.nlr.nl