



Dedicated to innovation in aerospace

NLR-TP-2017-214 | May 2017

Perception Model Analysis of Flight Simulator Motion for a Decrab Maneuver

CUSTOMER: NIVR

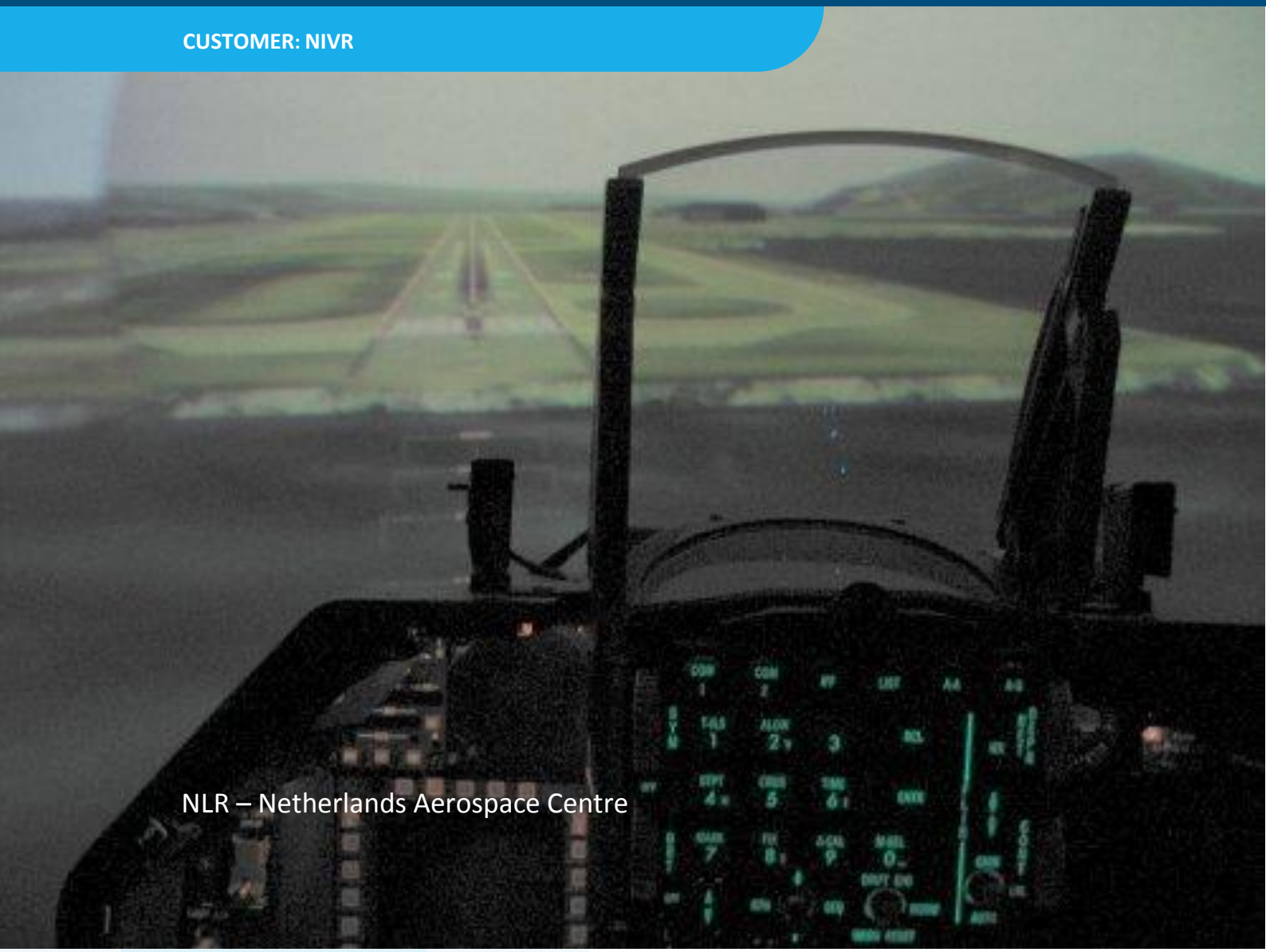

NLR – Netherlands Aerospace Centre

Netherlands Aerospace Centre

NLR is a leading international research centre for aerospace. Bolstered by its multidisciplinary expertise and unrivalled research facilities, NLR provides innovative and integral solutions for the complex challenges in the aerospace sector.

NLR's activities span the full spectrum of Research Development Test & Evaluation (RDT & E). Given NLR's specialist knowledge and facilities, companies turn to NLR for validation, verification, qualification, simulation and evaluation. NLR thereby bridges the gap between research and practical applications, while working for both government and industry at home and abroad.

NLR stands for practical and innovative solutions, technical expertise and a long-term design vision. This allows NLR's cutting edge technology to find its way into successful aerospace programs of OEMs, including Airbus, Embraer and Pilatus. NLR contributes to (military) programs, such as ESA's IXV re-entry vehicle, the F-35, the Apache helicopter, and European programs, including SESAR and Clean Sky 2.

Founded in 1919, and employing some 650 people, NLR achieved a turnover of 71 million euros in 2016, of which three-quarters derived from contract research, and the remaining from government funds.

For more information visit: www.nlr.nl

Perception Model Analysis of Flight Simulator Motion for a Decrab Maneuver



Problem area

Compared to the technological advancements in simulators and image generation, the technique of motion cueing has not significantly changed since the beginning of the 1970's. The "tuning" of a motion system for a flight or driving simulator still is a highly subjective, and therefore costly, process. Currently, there is a lack of objective evaluation criteria specifying the motion requirements for the simulation of different aircraft (transport, fighter, or rotary wing) or maneuvers. In the light of the growing demands for ground-based simulation, the efforts to optimise motion control should be in accordance with the relevance of a maneuver for training purposes.

Description of work

In this project, the problem of evaluating and optimising simulator motion cues is addressed. The project, granted by the Netherlands Agency for Aerospace Programmes (NIVR), was performed as a collaborative research between the Netherlands Aerospace Centre NLR and the TNO Human Factors Department (TNO-TM). The main purpose of the project, conducted from beginning 2003 to mid 2005, was to deliver a proof-of-concept of a pilot motion perception model, developed by TNO, for the off-line evaluation of the motion fidelity of ground-based flight simulators. A simulator evaluation was performed in the NLR's Generic Fighter Operations Research Cockpit Environment (GFORCE) in 2004.

REPORT NUMBER

NLR-TP-2017-214

AUTHOR(S)

M.H. Smaili
E.L. Groen
R.J.A.W. Hosman

REPORT CLASSIFICATION

UNCLASSIFIED

DATE

May 2017

KNOWLEDGE AREA(S)

Training, Mission
Simulation and Operator
Performance
Cockpit
Flight Operations
Safety

DESCRIPTOR(S)

Motion cueing
flight simulation
flight training
motion perception
motion drive algorithms

Results and conclusions

The main results of the study show that perceived self-motion during a simulated asymmetric decrab maneuver is largely determined by platform sway and roll. Yaw motion only had a minor effect, which was overshadowed in the presence of platform sway. The motion perception model output showed good correspondence to the pilots' magnitude ratings. The subjective data will be used to further optimize the model parameters to allow for quantitative analysis of the effectiveness of ground-based motion cues.

Applicability

The results of this study may be especially beneficial within the Netherlands infrastructure of simulator industries, training providers and end-users.

GENERAL NOTE

This report is based on a paper published in the AIAA Journal of Aircraft, March-April 2007, by AIAA.

NLR

Anthony Fokkerweg 2
1059 CM Amsterdam

p) +31 88 511 3113 f) +31 88 511 3210

e) info@nlr.nl i) www.nlr.nl



Dedicated to innovation in aerospace

NLR-TP-2017-214 | May 2017

Perception Model Analysis of Flight Simulator Motion for a Decrab Maneuver

CUSTOMER: NIVR

AUTHOR(S):

M.H. Smaili

E.L. Groen

R.J.A.W. Hosman

NLR

TNO

AMS Consult

This report is based on a paper published in the AIAA Journal of Aircraft, March-April 2007, by AIAA.

The contents of this report may be cited on condition that full credit is given to NLR and the author(s).

CUSTOMER	NIVR
CONTRACT NUMBER	BRP 49313 TM
OWNER	NLR + partner(s)
DIVISION NLR	Aerospace Operations
DISTRIBUTION	Unlimited
CLASSIFICATION OF TITLE	UNCLASSIFIED

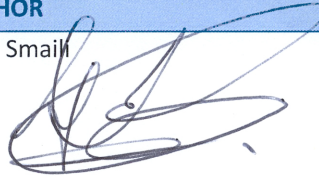
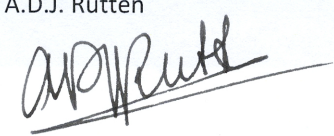
APPROVED BY :											
AUTHOR				REVIEWER				MANAGING DEPARTMENT			
M.H. Smail 				External reviewers				A.D.J. Rutten 			
DATE	2	2	0	5	1	4	DATE				
							DATE	2	3	0	5
											(7)

Contents

Nomenclature	5
I. Introduction	5
II. Flight Simulator Experiment	6
A. Simulator Facility	6
B. Pilots	6
C. Aircraft Model	6
D. Experimental Design	7
E. Procedure	7
III. Motion Perception Model	7
IV. Results	10
A. Subjective Magnitude Ratings	10
B. Correlation Between Model Output and Subjective Magnitude Ratings	10
V. Discussion	12
A. Simulation of Decrab Manoeuvre	12
B. Model Validation	12
VI. Conclusions	13
Acknowledgements	13
References	13

This page is intentionally left blank.

Perception Model Analysis of Flight Simulator Motion for a Decrab Maneuver

E. L. Groen*

TNO Defense, Safety, and Security, 3769 ZG Soesterberg, The Netherlands

M. H. Smaili†

National Aerospace Laboratory, 1006 BM Amsterdam, The Netherlands

and

R. J. A. W. Hosman‡

AMS Consult, 2645 KN Delfgauw, The Netherlands

DOI: 10.2514/1.22872

In this flight simulator study, eleven pilots rated their motion perception during a series of decrab maneuvers of a twin-engine passenger aircraft. Simulator yaw, sway, and roll motion were varied independently to examine their relative contribution to the pilots' judgments. In one set of conditions, the washout algorithms were bypassed so as to reproduce unfiltered aircraft motion. This was compared with washout-filtered motion in another set of conditions. Moreover, the effect of visual cues was studied by testing the unfiltered motion cues, once with simulated outside view, and once without outside view. The results show that perceived alignment motion primarily depended on simulator sway and roll motion, and also visually induced motion. Simulator yaw was poorly recognized and was masked by simulator sway. Interestingly, unfiltered sway motion was perceived as too strong, even though the simulator workspace required downscaling to 70% of the actual aircraft motion. Finally, the subjective data were used to validate our pilot perception model. Although the model did not yet account for the observed interaction between sway and yaw motion, the model output showed good correspondence with the experimental pilot magnitude ratings. The subjective data will be used to further optimize the model parameters to allow for quantitative analysis of the effectiveness of ground-based motion cues.

Nomenclature

a_y	=	sway acceleration, m/s ²
$C_{y\beta}$	=	airplane side force due to sideslip
f_y	=	specific force along cockpit's y axis (external force per unit of mass, m/s ²)
g	=	gravitational acceleration (9.81 m/s ²)
K	=	filter gain
ℓ_z, ℓ_x	=	distance of cockpit from center of gravity along airplane body z axis, respectively, x axis, m
m	=	airplane mass, kg
q	=	dynamic pressure, N/m ²
S	=	wing surface area, m ²
t	=	time, s
u'	=	perceived parameter u
V_{ground}	=	airplane ground speed, m/s
V_{tas}	=	airplane true airspeed, m/s
V_{wind}	=	wind speed, m/s
β	=	sideslip angle, deg
$\psi, \dot{\psi}, \ddot{\psi}$	=	yaw angle, rate, respectively, acceleration, deg, deg/s, deg/s ²
$\phi, \dot{\phi}, \ddot{\phi}$	=	roll angle, rate, respectively, acceleration, deg, deg/s, deg/s ²

ω = natural frequency of a washout filter, rad/s

I. Introduction

MODELS of pilot control and perception can be helpful in the offline assessment of motion requirements for flight simulation [1,2]. The two types of models relate to different levels of a nested control loop: an inner loop relating to attitude control, and an outer loop relating to situational awareness [3]. This distinction is important because there may be situations where simulator motion has no marked effects on pilot control inputs, but still is perceptibly different from actual aircraft motion. Pilot control models often employ a vestibular model, composed of transfer functions of the semicircular canals and otoliths, to optimize the correspondence between the pilot's sensory responses in the simulator and in the real aircraft [3–6]. In contrast, pilot perception models, such as the one developed at TNO, also include multisensory interactions accounting for the central interpretation of sensory cues by the central nervous system (CNS) [7,8]. The input for this TNO model is a six degrees-of-freedom (DOF) time history of aircraft or simulator motion. The output gives the time histories of perceived self-motion and orientation (i.e., attitude). In two previous papers we reported on the effectiveness of the model in evaluating the simulation of a takeoff run [8], and the simulation of the rotation and first segment climb [9], respectively. The required psychophysical data were obtained in two flight simulator studies [10,11]. This new study was designed to validate the model for an asymmetric flight maneuver, which is more motion critical than both previous symmetric maneuvers.

The selected asymmetric maneuver was an early decrab during the final approach of a crosswind landing (Fig. 1). This maneuver aligns the aircraft's heading with the runway before touchdown in the presence of crosswind conditions. In coordinated flight and before decrabbing, the aircraft is pointed a few degrees into the wind. The pilot applies rudder to align the aircraft with the centerline, thereby introducing a slip angle. At the same time, the upwind wing is

Presented as Paper 6108 at the Modeling and Simulation Technologies Conference, San Francisco, California, 15–18 August 2005; received 31 January 2006; accepted for publication 15 October 2006. Copyright © 2006 by TNO Defence, Security and Safety. Published by the American Institute of Aeronautics and Astronautics, Inc., with permission. Copies of this paper may be made for personal or internal use, on condition that the copier pay the \$10.00 per-copy fee to the Copyright Clearance Center, Inc., 222 Rosewood Drive, Danvers, MA 01923; include the code 0021-8669/07 \$10.00 in correspondence with the CCC.

*Aerospace Physiologist, Education and Training Department, P.O. Box 23. AIAA Member.

†Aerospace Engineer, Training, Human Factors and Cockpit Operations Department, P.O. Box 90502. AIAA Member.

‡Pilot/Aerospace Engineer, Dijkgraafstraat 26. AIAA Member.

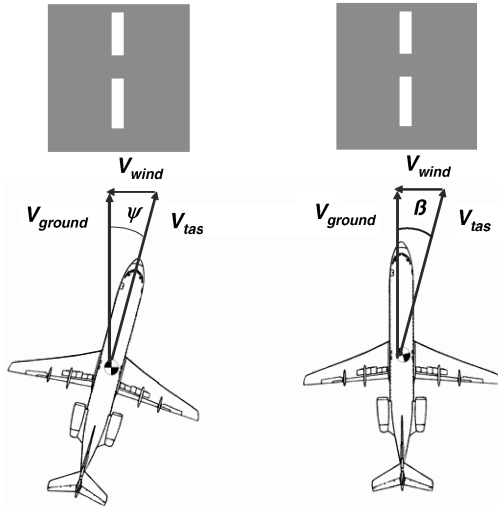

Fig. 1 Geometry of the decrab maneuver for right crosswind, before (left plot) and after (right plot) heading alignment with the runway.

lowered so as to prevent downwind drift. Banking the aircraft tilts the lift vector toward the upwind side, providing a force that counteracts the effect of sideslip on the fuselage. In terms of motion cues acting on the pilot, the decrab thus consists of a combination of yaw and roll motion. In addition, with the cockpit of transport aircraft located at a considerable distance in front of the center of gravity, yaw acceleration automatically generates sway acceleration at the pilot's position, according to

$$a_y = \dot{r}l \quad (1)$$

This leads to the research question whether yaw, sway, or both motion cues are equally useful to the pilot. Moreover, the attitude change in roll causes gravity to project along the pilot's y axis (g_y) which may be confused with the sway acceleration a_y , taking place in the same plane. The TNO perception model takes this perceptual ambiguity between linear acceleration and tilt into account. This addresses the second research question, whether the perception model explains how these ambiguous motion cues, sway or roll, are interpreted. These two research questions can be formulated as two hypotheses:

- 1) The perceived motion during a simulated decrab maneuver equally depends on aircraft yaw and sway.
- 2) The subjective magnitude ratings of alignment motion highly correlate with the output of the motion perception model.

A unique element in the present simulator experiment was that, by preprogramming simulator motion, we were able to reproduce the actual aircraft motion for the simulated maneuver without transformation by washout algorithms. The rationale for this was



Fig. 2 NLR research flight simulator (GFORCE) with the six-DOF motion system in its neutral position (left), and prepositioned for simulation of direct motion (right).

that the transfer functions in the washout software change their dynamics.

II. Flight Simulator Experiment

A. Simulator Facility

The simulator experiment took place in the generic fighter operations research cockpit environment (GFORCE) simulator of the National Aerospace Laboratory NLR in Amsterdam (Fig. 2). This facility features a modifiable modular F-16 fighter cockpit placed inside a 6 m dome projection system. The 6-DOF motion platform consists of a hydraulic hexapod, manufactured by Bosch Rexroth Hydraulix (Bostel, The Netherlands). The motion platform is characterized by a high bandwidth (45 deg phase lag at 4 Hz). Maximum excursions are ± 29 deg for pitch, ± 30 deg for roll, ± 41 deg for yaw, a total of 2.1 m for heave, ± 1.4 m for sway, and $+1.7/-1.3$ m for surge. The visual system consists of a three channel Evans & Sutherland ESIG-3000 computer image generation system. The field of view of the out-the-window image amounts to 140 deg (horizontal) \times 110 deg (vertical), with a high resolution inset of 50×30 deg. The resolution of the background amounts to 21.2 arcmin per optical line pair (OLP), and the average luminance is $4.24 \text{ ft} \cdot \text{L}$. The inset has a resolution of 7.1 arcmin per OLP, and a luminance of $6.83 \text{ ft} \cdot \text{L}$. The refresh rate of the visual system is 60 Hz, with a delay of about 50 ms. The delay of the motion system is on the order of 10 ms.

The visual database featured San Francisco International Airport and surrounding area under varying visibility daylight conditions (see below). In the experiment only the following basic flight instruments were functional: attitude indicator, altimeter, airspeed, and heading indicator. Figure 3 shows a sequence of simulated outside view during the decrab maneuver. Pilots wore a lightweight headset for communication with the experimenter. The headset in combination with the noise in the cockpit effectively masked the simulator motion. No aircraft sound cues were simulated.

B. Pilots

Eleven professional airline pilots volunteered in this study (mean age 41 years, 7000 flight hours). They all were experienced on a twin-engine 100 passenger aircraft such as a Fokker F100. For two reasons, we decided not to give the pilots an active flight task. First, as airline pilots they were unfamiliar with the layout of the fighter cockpit. Second, by having the pilots passively monitor an autoland decrab, we were able to carefully control the motion profile. Hence, all pilots were exposed to exactly the same inertial motion stimuli.

C. Aircraft Model

The aircraft model was developed in MATLAB® Simulink®, and derived from the decrab maneuver in the final approach phase of a Fokker 100 with the autopilot engaged (Fig. 4). Because we wished to preprogram different motion conditions without running the full nonlinear aircraft model, we developed a simplified model of the



Fig. 3 Time-lapse images from inside the cockpit showing the sequence of the simulated decrab maneuver (from left to right).

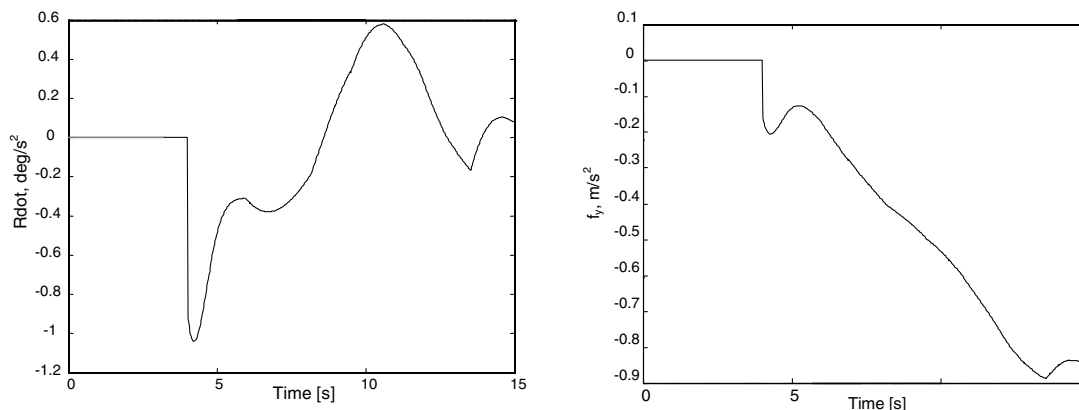

Fig. 4 Time history of yaw acceleration (left) and specific force (right) during an autoland decrab of F-100 aircraft model.

decrab as a part-task system. The input of this model consists of a heading alignment command profile ($\dot{\psi}_c$), derived from the autoland decrab profile of a Fokker 100. Assuming level flight, the simplified model computed the aircraft response in terms of linear and angular accelerations, velocities, and attitude (Fig. 5). Maximum aircraft yaw rate and acceleration amounted to 2 deg/s, respectively, 1.2 deg/s², the latter corresponding to a sway acceleration of 0.3 m/s² at the height of the cockpit. The model output was input to the motion driving algorithms, and the aircraft geographic position was sent to the simulator visual system. We did not measure actual platform motion, so that all motion profiles in this paper refer to the command signals to the motion platform. According to the specifications described in [12], the GFORCE motion system has a bandwidth of 4 Hz which assures a dynamic response within 90% of the commanded signal for frequencies up to 1 Hz. Between 1 and 4 Hz the response is within 70% of the commanded signals.

D. Experimental Design

In total there were 24 different conditions, schematically depicted in Fig. 6. Simulator motion consisted of yaw, sway, and roll motion. Each of the three motion cues could be either present or absent, giving eight possible combinations ($2 \times 2 \times 2$). These eight different motion profiles were input to the motion platform after transformation by the washout software in one set of conditions (washout motion). Classical washout was applied with second order high- and low-pass filters (Table 1). The nonlinear rate limiter in the tilt-coordination channel was not active for the decrab maneuver and was removed. The washout parameters were chosen to obtain representative washout without strong attenuation. Sway, roll, and yaw motion could be switched off by making the corresponding gains zero. In another set of conditions (direct motion), the motion output from the aircraft model was sent directly to the motion platform, thus bypassing the washout filters. In these conditions the simulator was prepositioned in its outmost lateral position (Fig. 2, right-hand picture), so as to use the maximum linear travel of 2.5 m.

By simulating both linear and rotational motion aspects of the decrab maneuver *unfiltered*, the temporal behavior of simulator motion is identical to that of the aircraft. The only compromise was a 30% reduction in amplitude (i.e., a gain of 0.7), which was necessary to stay within the simulator's linear workspace. Finally, to examine the influence of visual inputs we tested the set of eight direct motion conditions twice: once with clear visibility (simulated VMC, or visual meteorological conditions), providing visual motion cues on the maneuver, and once with zero visibility (simulated IMC, or instrument meteorological conditions), providing no visual information on the maneuver. In the IMC conditions the runway was covered by a cloud layer, which the aircraft entered just before the heading alignment commenced. For time considerations, washout motion conditions were only tested with clear visibility (VMC). This explains the empty quadrant on the bottom right in Fig. 6.

Airspeed was always 128 kn, and crosswind velocity 30 kn, corresponding to a slip angle of 13 deg. Crosswind was simulated from the left. All 24 conditions were presented in randomized order during one experimental session of 45–60 min.

E. Procedure

Pilots were asked to rate the perceived *magnitude* of the heading alignment on a labeled rating scale (Table 2). Hence, these ratings specifically relate to the transient heading change of the aircraft, not to the stabilized roll. In addition to the rating task, pilots also indicated whether they could differentiate the alignment motion into yaw or sway motion. In a third rating scale pilots were asked to comment on the realism of the simulator motion. The results of this task are beyond the scope of this paper, and the interested reader is referred to [13].

III. Motion Perception Model

Figure 7 outlines the three-dimensional motion perception model. The model is implemented in MATLAB Simulink and contains a set

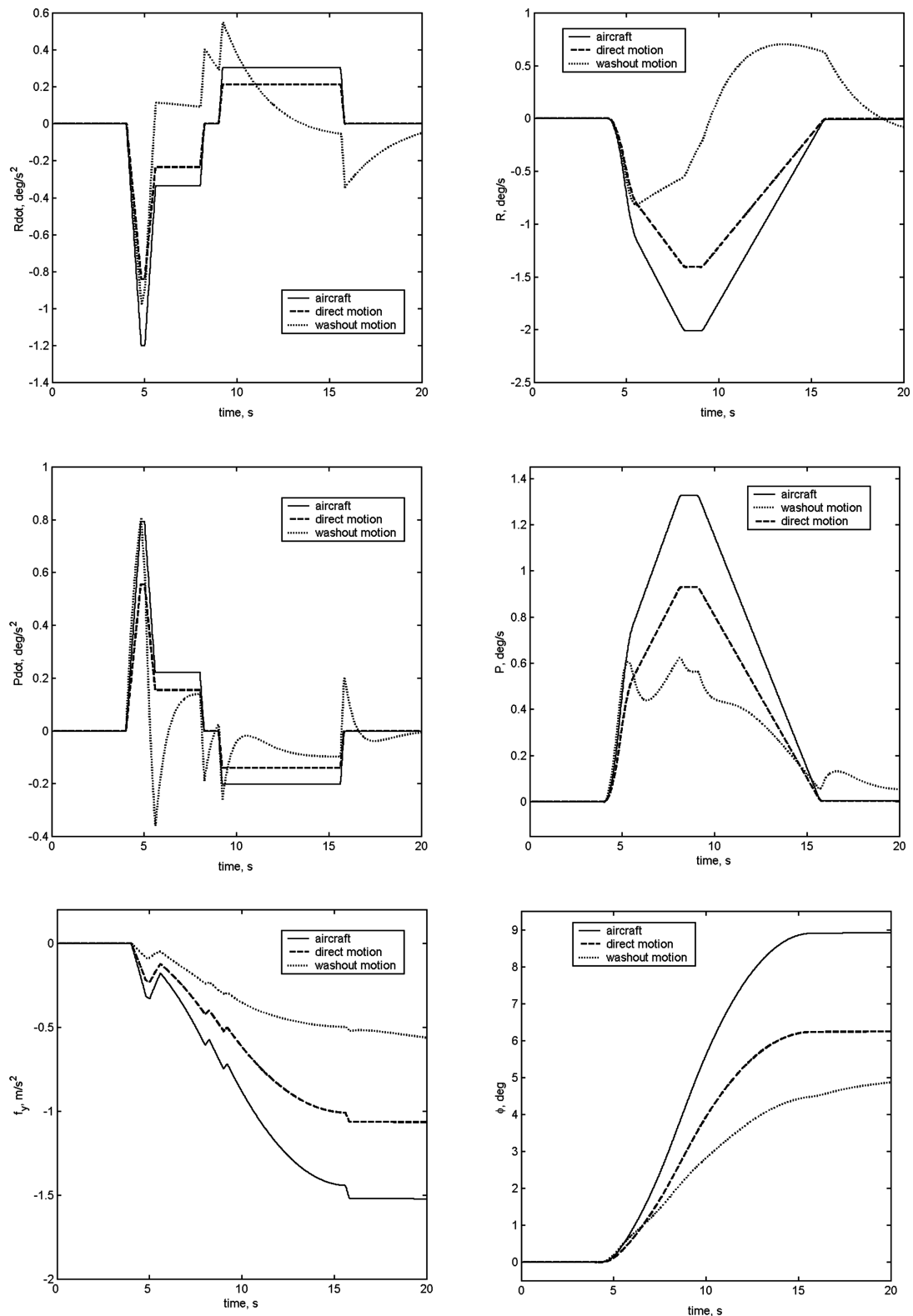

Fig. 5 Output of the simplified aircraft model (solid black lines), and the corresponding simulator motion with direct motion (dotted lines), and washout motion (gray lines).

of transfer functions characterizing the primary sensory systems involved in human motion perception. First, the vestibular system (semicircular canals, SCC, and otoliths, OTO) detects linear accelerations (f) and rotations (ω) of the head. Second, the visual system is sensitive to optic flow (FLW) associated with self-motion, which can be separated into linear (v_{vis}) and angular flow (ω_{vis}). In addition, the visual input may also reveal the orientation with respect

to gravity (g_{vis}). This visual cue is referred to as “visual frame” (FRM). An essential part of the model consists of the intersensory interactions that take place on a more central level in the brain. Particularly important is the neural resolution of the perceptual ambiguity between translation and tilt. This essentially uses low-pass filtering to account for the fact that gravity is always constant, whereas accelerations due to natural head motions are usually

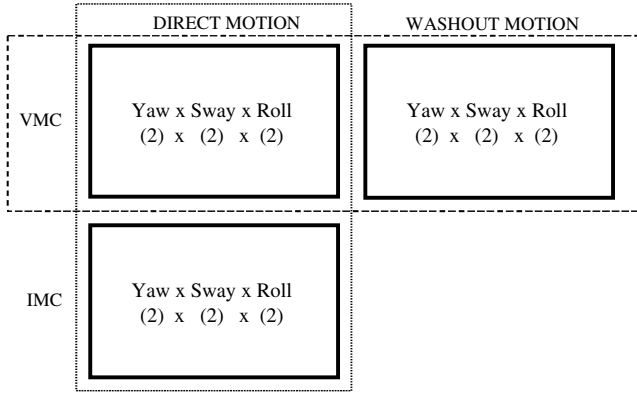

Fig. 6 Experimental design with motion (direct vs washout) and visual condition (VMC vs IMC) as grouping variables.

variable. The model output gives a prediction of perceived angular and linear motion, as well as perceived attitude (represented in Fig. 7 by the “subjective vertical” or SV' , which corresponds to the perceived body orientation with respect to the Earth vertical). The various parameters are based on data from the literature and also from psychophysical studies from our laboratory [14–17].

The six-DOF time histories of simulator (command) motion of all 24 conditions were analyzed offline with the perception model. An example of this is given in Fig. 8 for the perception of sway acceleration (upper row) and yaw rate (bottom row) with visual motion (VMC, dotted line) and without visual motion (IMC, solid gray line). Simulator motion (solid black line) in this example consisted of all three components, that is, yaw, sway, and roll. To demonstrate the effect of washout, the left-hand plots contain the model response to direct motion, and right-hand plots contain the model response to washout motion. Both upper plots show that the model predicts that the specific force (f_y) along the simulator cockpit’s y axis is correctly perceived as sway (a'_y) in the transient alignment phase (indicated by the arrow at $t = 5$ s), independent of visual motion. Sway acceleration reached a smaller amplitude in the washout condition. An interesting element in the direct motion condition is that the perceived yaw magnitude (lower left) is larger than the actual simulator yaw, due to a contribution of visual yaw cue.

The model produces time histories of perceived self-motion, so that some extra processing was required to enable comparison with the subjective magnitude ratings. Assuming that pilots based their judgements on maximum simulator motion, we computed the maximum values of model-predicted yaw rate (r') and sway acceleration (a'_y) during alignment (shown by the arrow in Fig. 8 for

Table 1 Washout filter parameters

Mode	Filter type	Gain	ω_m , rad/s	ζ
Sway	High pass	0.5	0.25	1.0
Tilt coordination	Low pass	0.6	1.0	1.0
Roll	High pass	0.6	0.25	1.0
Yaw	High pass	1.0	0.25	1.0

Table 2 Labeled rating scale

Rating	Description
0	Absent
0.5	Barely noticeable
1	Weak
2	Fairly
3	Clear
4	Strong
5	Very strong

model-predicted sway acceleration). Note that this automatically accounts for a possible contribution of simulator roll motion, since model-predicted sway (a'_y) also includes a response to the lateral component of specific force (f_y) that results from simulator roll. Hence, model-predicted yaw and sway together describe the perceived alignment motion. Because model-predicted yaw was expressed in deg /s, and model-predicted sway in m/s^2 , the next step was to normalize maximum yaw and sway outputs into equivalent units. This was done by dividing the maximum values by their respective perceptual thresholds. For yaw motion we took a threshold of 1.0 deg /s (although the semicircular canals respond to angular acceleration, the perceptual threshold for angular motion can be considered a function of *velocity* in the frequency range of natural head movements [18]). For sway acceleration we chose a threshold of 0.06 m/s^2 (according to [19,20]). Thus we obtained dimensionless yaw and sway magnitudes for all conditions, which were then combined into a single normalized value, according to

$$\frac{w_{yaw}(|r'|/1) + w_{sway}(|a'_y|/0.06)}{w_{yaw} + w_{sway}} \quad (2)$$

where $r' = 0$ when $r' < 1$ deg /s, and $a'_y = 0$ when $a'_y < 0.06$ m/s^2 .

Neural combination of multimodal cues often involves weighted addition [21], and we included weight factors w_{yaw} and w_{sway} into Eq. (2). However, without a priori knowledge on the relative contributions of yaw and sway, we set $w_{yaw} = w_{sway} = 1$. The resulting values of model-predicted perception of alignment motion are shown in Fig. 9.

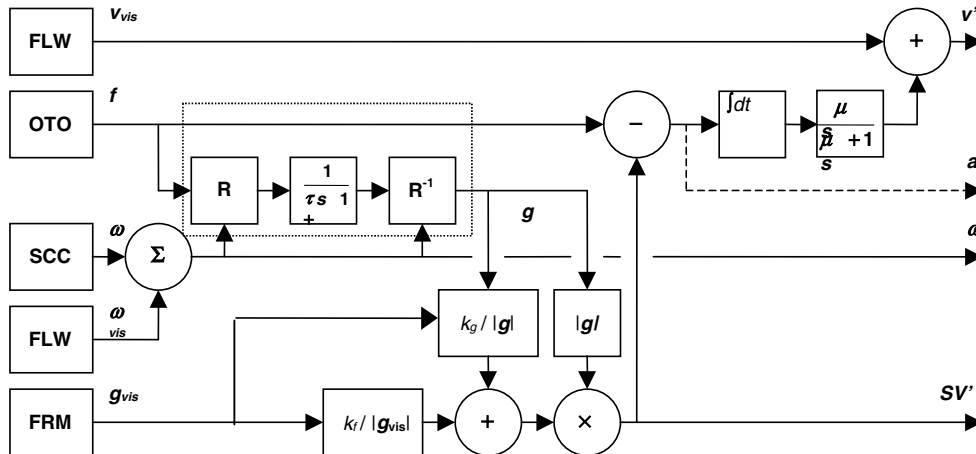

Fig. 7 Sensory interactions in the TNO motion perception model describing perceived self-orientation (subjective vertical, SV'), linear acceleration (a'), angular (ω') and linear velocity (v') in response to specific force (f) and angular motion (ω). FLW = optic flow; OTO = otoliths; SCC = semicircular canals; FRM = visual frame.

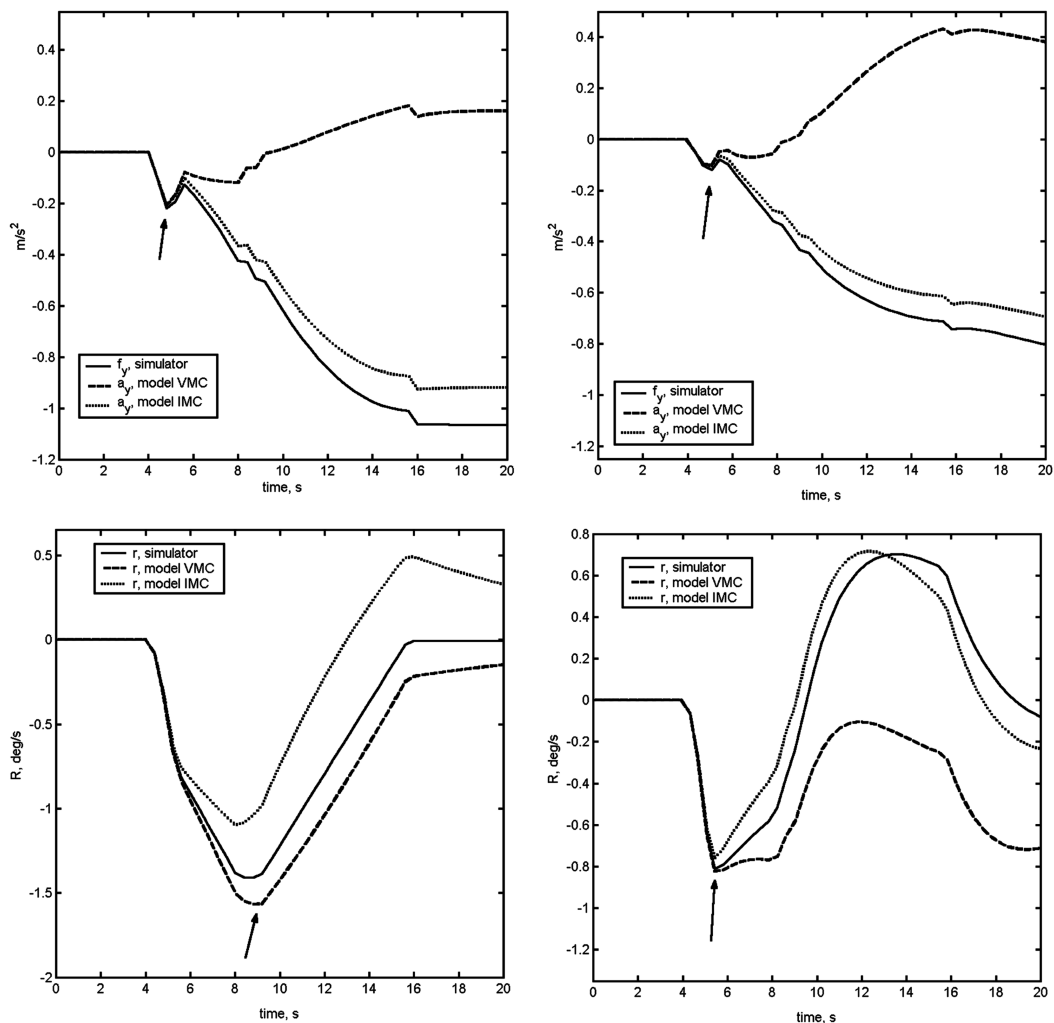

Fig. 8 Model-predicted perception of sway acceleration (upper row) and yaw rate (bottom row) for direct motion (left column) and washout motion (right column). The arrows indicate the maximum value that was used for comparison with the subjective magnitude ratings.

To test the relative importance of yaw and sway motion, we analyzed the subjective magnitude ratings using a within-subjects analysis of variance (ANOVA). Because the experimental design was not completely symmetrical (the washout conditions were only tested in simulated VMC, not in simulated IMC), we carried out two different analyses. One analysis concerned all VMC conditions testing the factors: washout (2) \times roll (2) \times yaw (2) \times sway (2). The other analysis concerned all direct motion conditions, testing the factors visual (2) \times roll (2) \times yaw (2) \times sway (2). The correlation between the model output and the subjective magnitude ratings was tested with a nonparametric Spearman's correlation, accounting for the fact that the model-predicted values will be differently distributed as compared to the ordinal values of the labeled rating scale (Table 2). In all analyses, effects with $p < 0.05$ were considered significant.

IV. Results

A. Subjective Magnitude Ratings

For technical reasons the data set of the first two pilots was incomplete, and their data were discarded. The average magnitude ratings ($n = 9$) for the alignment phase in all conditions is shown in Fig. 10. The ANOVA revealed various effects. First, there was a main effect for washout, with direct motion being rated stronger than washout motion. Second, there was a main effect for visual information, with VMC leading to higher ratings than IMC conditions. Third, conditions with sway motion gave significantly stronger motion sensations than conditions without sway. Finally, simulator roll also positively contributed to magnitude ratings of alignment motion. Remarkably, yaw motion did not produce a main

effect. However, it resulted in a two-way interaction with sway, such that yaw motion only contributed to the pilots' judgements when sway motion was absent. It is noteworthy that pilots were solicited to write down some general comments after each condition. From this we learned that pilots collectively judged conditions with direct sway motion as "too strong."

B. Correlation Between Model Output and Subjective Magnitude Ratings

Comparison of the model-predicted values in Fig. 9 with the mean pilot ratings in Fig. 10 shows that the model generally produced the same pattern as the subjective data. For example, similar to the pilot ratings, the model output was structurally higher in conditions with sway than without sway. The model also accounted for a positive contribution of roll motion to the perception of alignment motion in VMC conditions (compare the "roll off" plot with the adjacent "roll on" plot). This was also observed in the pilot responses, although the model-predicted contribution of roll motion was not very visible in conditions with sway motion. The main difference between model output and pilot data concerns the effects of yaw motion. The model output correctly showed no effect of yaw in the washout conditions (the model-predicted yaw remained under the above-mentioned threshold of 1.0 deg/s), but did predict a clear effect of yaw in the direct motion conditions, independent of sway motion. The latter behavior is not reflected in the pilot ratings, where the small contribution of yaw was completely overshadowed by sway. Nevertheless, the correlation between the model output and the mean pilot ratings was significant (Fig. 11). The Spearman correlation

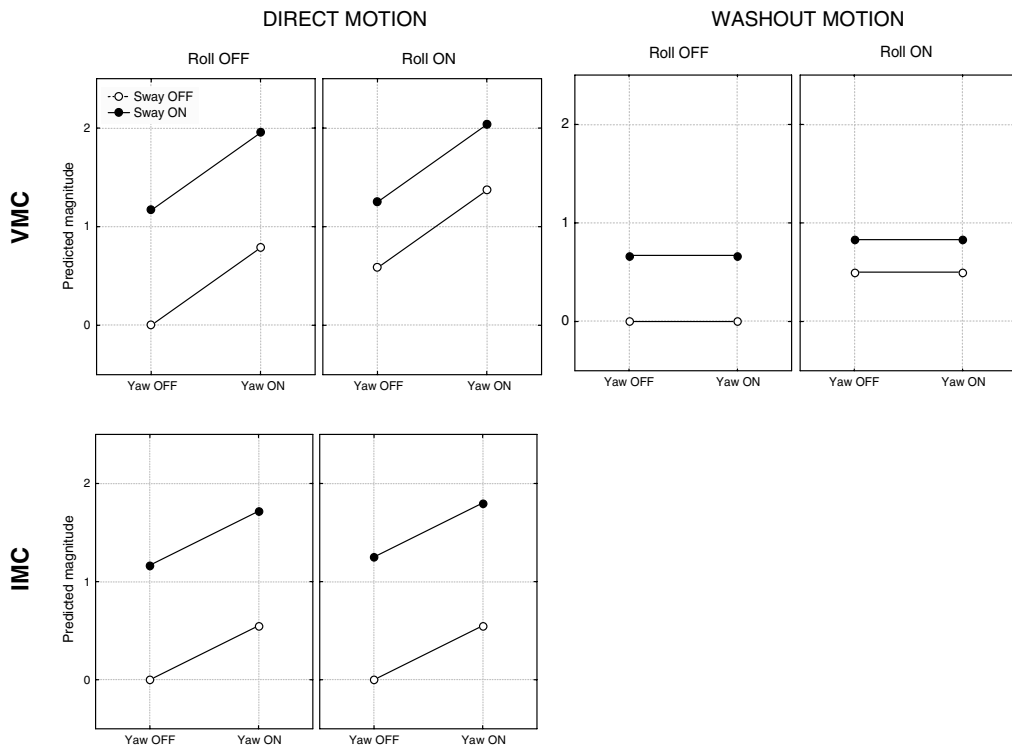

Fig. 9 Model-predicted perceived magnitude of alignment motion (arbitrary units).

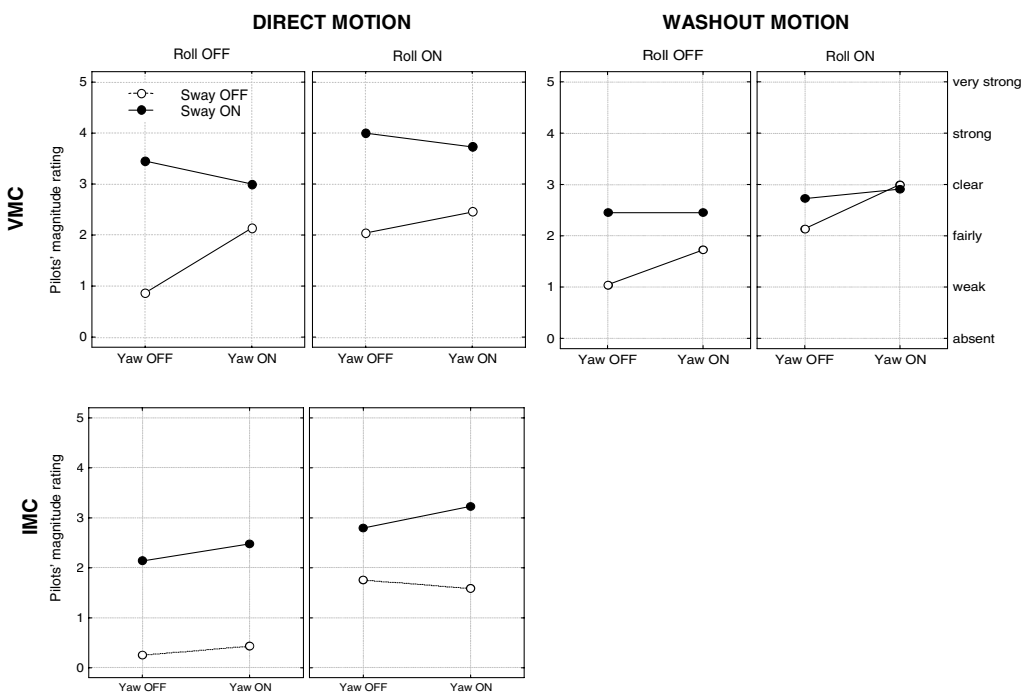

Fig. 10 Mean subjective pilots' magnitude rating for alignment motion.

coefficient amounted to $R = 0.70$, indicating that the model explained about 50% of the variance in the pilot data.

C. Motion Interpretation

The pilots mentioned that it was often difficult to decide whether simulator motion during the alignment phase consisted of pure yaw, sway, or a combination of both. In fact, two pilots could not differentiate between yaw and sway, and said that it just felt like “alignment motion.” To illustrate this, Table 3 shows the percentage of cases in which platform motion was interpreted as yaw, sway, a

combination of both, or no motion at all, for the direct motion conditions with VMC. In all conditions, simulator motion was reported as a combination of yaw and sway by 30–60% of the pilots. In the fixed-base condition (leftmost column) pilots sensed some kind of alignment motion in 60% of the cases, indicating the effectiveness of the visual scene to induce vection. Remarkably, in the fixed-base condition under IMC (not shown in the table) still 30% of the pilots reported some alignment motion, despite the absence of any visual or physical feedback on the decrab. According to Fig. 10 the average magnitude in this condition was almost zero (“just noticeable”), and thus not completely absent.

Table 3 Percentages showing how platform motion was interpreted in VMC conditions (direct motion)

Interpretation	Roll off				Roll on			
	Sway off		Sway on		Sway off		Sway on	
	Yaw off	Yaw on	Yaw off	Yaw on	Yaw off	Yaw on	Yaw off	Yaw on
Yaw	20	40	27	13	27	33	13	13
Sway	7	0	27	27	6	7	33	27
Both	33	53	46	60	60	60	54	60
No motion	40	7	0	0	7	0	0	0

V. Discussion

A. Simulation of Decrab Maneuver

The subjective perception of the heading alignment during the decrab maneuver primarily depended on simulator sway and roll, rather than simulator yaw. The small effect of yaw was overshadowed in the presence of sway motion. Hence, we must reject our first hypothesis, stating that yaw and sway motion provide equal motion feedback to the pilot in this asymmetric flight maneuver. Although our results apply to pilots who did not have an active control task, it is likely that sway motion is also the most critical motion cue in other asymmetric flight maneuvers, such as engine failure. Two recent helicopter simulator studies demonstrated that pilot performance benefited more from sway than yaw in an active 15 deg yaw capture task [22,23]. The fact that similar results are obtained in different simulators, different pilot tasks, and different flight maneuvers strongly suggests that aircraft yaw is not always the most relevant cue to reproduce in a simulator. A practical consequence worth considering is that actuator length can be used more efficiently when yaw is not to be simulated anymore.

The positive effect of roll motion to perceived alignment motion that we found can be attributed to the gravitational component along the pilot's y axis that results from simulator tilt. With the correct visual stimulus, this gravitational component is interpreted by the pilot as lateral acceleration instead of tilt. In addition to sway and roll motion, visual motion cues (in the VMC conditions) also improved pilots' judgements. Remarkably, according to the motion interpretation task about 30% of the pilots still sensed some alignment motion in the IMC condition without simulator motion (i. e., fixed base). This indicates that pilots sometimes perceive the type of motion that they expect, similar to an earlier finding in the vestibular laboratory where motion perception was shaped by the subjects' a priori knowledge of the motion device [24]. We anticipate that this effect will even be more manifest in man-in-the-loop situations, where the pilot actively controls the simulator and thus expects specific motion feedback. The phenomenon that the human brain sometimes "fills in" missing information is one of the most difficult aspects to capture in perception modeling, but internal models offer a valuable approach in this respect [7].

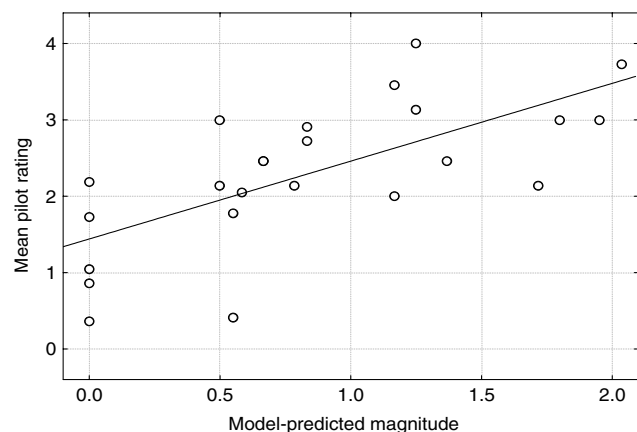

Fig. 11 Correlation between the mean pilots' magnitude rating and the model-predicted magnitude.

An important element in this study was the use of direct, that is, unfiltered motion. By prepositioning the simulator, the linear travel of the motion platform approximated that of the actual aircraft. The only difference was a downscale factor of 0.7, necessary to stay within the motion system's workspace. Most pilots commented that this unfiltered sway motion felt unacceptably strong, despite the downscaling. This confirms previous findings that linear acceleration cues are structurally overestimated in a simulator environment [10,25,26]. This phenomenon is not found for angular motion [11,27]. In previous studies the dynamics of the washout filter may have had an unknown contribution to this effect [28]. However, in the present study we can be sure that it is the amplitude, rather than the temporal behavior of the linear motion cue that was overestimated. Still, it remains a question why linear motion is overestimated in a simulator but not in the real aircraft. Most likely, the simulator visual display plays a role in this effect, but it is still unclear which factor would be most important (e.g., edge rate, field of view, focusing distance, resolution, brightness, contrast, etc.).

B. Model Validation

To enable quantitative comparisons between the model output and the subjective pilot ratings, we took the maximum value of the model-predicted time histories of perceived yaw and sway, where both signals included the response to inertial and visual motion stimulus. In addition, the model-predicted sway also contained a component due to simulator roll. We combined these maximum yaw and sway values into a single magnitude value, by dividing them by the corresponding perception thresholds. Obviously, the outcome of this computation will vary greatly with the chosen threshold value. The problem is that our current knowledge on perception thresholds only partially applies to the simulator environment. The literature often describes thresholds that hold for single-axis motion in the dark. This is not automatically the same as the detection of self-motion in a dynamic visual environment, such as in a simulator with an out-the-window display. For example, whole-body tilt is detected at a rate of about 0.5 deg/s in blindfolded subjects, but only at 3 deg/s when there is a visual frame of reference that remains aligned with the subject, as is the case with tilt coordination [25]. Furthermore, the measured thresholds depend on many other factors, such as the type of motion stimulus and its duration, the psychophysical procedure, and the illumination [19,29,30]. Evidently, the thresholds we used in our model validation are open for discussion, and other values may lead to better model-predicted magnitudes. Nevertheless, relative to the used thresholds model-predicted sway was about 2 times stronger than model-predicted yaw (e.g., in the example of Fig. 8 the sway output is about 2–3 times the threshold of 0.06 m/s², and the yaw output is 1–1.5 times the threshold of 1 deg/s). Although this does correctly predict that sway is judged stronger than yaw, the subjective data showed that the perception of yaw was completely suppressed by sway. This interaction was not present in the model output, where yaw and sway outputs were equally weighted [Eq. (2)]. Further experiments will be needed to determine the exact relative weighting between yaw and sway, or the relative weighting between other cues for that matter.

Finally, this experiment concentrated on passive observation by experienced pilots. The decrab maneuver is a highly control-feedback oriented one, where the hands and feet work interactively to bring the aircraft heading in line with the runway heading. Moreover,

the control strategy used by pilots may also differ; for example, one may decrab very early and slowly, while another at the last moment possible, may minimize trim drag. It can therefore be expected that results in a piloted decrab will differ from the results presented here. For this reason we are currently planning follow-up studies that concentrate on man-in-the-loop tasks [31].

VI. Conclusions

We conclude that the most effective motion feedback for the simulation of the heading alignment during a decrab maneuver consists of simulator sway and roll, not yaw. Visual feedback on the maneuver also contributes in a positive way. To achieve realistic simulation, the sway motion cue should be considerably smaller than that of the actual aircraft. In this sense, the downscale factor inherent to washout algorithms has a beneficial side effect for the simulation of linear accelerations. With respect to the motion perception model we conclude that it is quite difficult to quantify motion perception in a dynamic motion environment. Still, the model output closely resembles the actual pilot data, but implementation of validated perceptual thresholds is needed to further improve the applicability of the model.

Acknowledgments

This work was supported by the Basic Research Project “49313 TM,” granted by the Netherlands Agency for Aerospace Programmes, NIVR. The authors would like to thank Jacco Dominicus and Paul Breed for their professional support in setting up the flight simulator. Jelte Bos made an invaluable contribution in the human perception modeling. Motion specialists of the Research and Development Department of Bosch-Rexroth, Inc., gave their advice on the simulated flight maneuver. Finally, the authors are grateful to Sunjoo Advani for his useful comments.

References

- [1] Chung, W. Y., “A Review of Approaches to Determine the Effectiveness of Ground-Based Flight Simulation,” AIAA Paper A00-37311, 2000.
- [2] Hosman, R. J. A. W., “Are Criteria for Motion Cueing and Time Delays Possible?,” AIAA Paper CP-99-4028, 1999.
- [3] Hosman, R. J. A. W., “Pilot’s Perception and Control of Aircraft Motions,” Ph.D. Thesis, Delft University of Technology, The Netherlands, 1996.
- [4] Sivan, R., Ish-Shalom, J., and Huang, J. K., “An Optimal Approach to the Design of Moving Flight Simulators,” *IEEE Transactions on Systems, Man and Cybernetics*, Vol. 12, No. 6, 1982, pp. 818–827.
- [5] Bussolari, S. R., Sullivan, R. B., and Young, L. R., “Vestibular Models For The Design And Evaluation Of Simulator Motion,” *Proceedings of the RAeS Conference on Advances in Flight Simulation—Visual and Motion Systems*, London, U.K., 1986.
- [6] Telban, R. J., Cardullo, F. M., and Houck, J. A., “Developments in Human Centered Cueing Algorithms for Control of Flight Simulator Motion Systems,” AIAA Paper CP-99-4328, 1999.
- [7] Bos, J. E., and Bles, W., “Theoretical Considerations on Canal-Otolith Interaction and an Observer Model,” *Biological Cybernetics*, Vol. 86, No. 3, 2002, pp. 191–207.
- [8] Bos, J. E., Bles, W., and Hosman, R. J. A. W., “Modeling Human Spatial Orientation and Motion Perception,” AIAA Paper CP-2001-4248, 2001.
- [9] Groen, E. L., Hosman, R. J. A. W., Bos, J. E., and Dominicus, J. W., “Motion Perception Modelling in Flight Simulation,” *Flight Simulation 1929-2029: A Centennial Perspective*, CP-13, Royal Aeronautical Society, London, U.K., 2004.
- [10] Groen, E. L., Valenti Clari, M. S. V., and Hosman, R. J. A. W., “Evaluation of Perceived Motion During a Simulated Takeoff Run,” *Journal of Aircraft*, Vol. 38, No. 4, 2001, pp. 600–606.
- [11] Groen, E. L., Hosman, R. J. A. W., and Dominicus, J. W., “Motion Fidelity During a Simulated Takeoff,” AIAA Paper CP-2003-5680, 2003.
- [12] Meerwijk, L., “On the Dynamic Performance of the NLR 6-DOF Motion System,” Memorandum NLR VS-91-003, 1991.
- [13] Groen, E. L., Smaili, M. H., and Hosman, R. J. A. W., “Motion Fidelity of a Simulated Decrab Maneuver,” AIAA Paper CP-2005-6108, 2005.
- [14] Groen, E. L., Howard, I. P., and Cheung, B. S. K., “Influence of Body Roll on Visually Induced Sensations of Self-Tilt And Rotation,” *Perception*, Vol. 28, No. 3, 1999, pp. 287–297.
- [15] Bos, J. E., Cheung, B. S. K., and Groen, E. L., “The Somatogravic Effect Without Concomitant Angular Motion,” TNO Rept. TM-01-002, TNO Human Factors, Soesterberg, the Netherlands, 2001.
- [16] De Graaf, B., Bos, J. E., Tielemans, W., Rameckers, F., Rupert, A. H., and Guedry, F. E., “Otolith Contribution to Ocular Torsion and Spatial Orientation During Acceleration,” NAMRL TM 96-3, Naval Aerospace Medical Laboratory, Pensacola, FL, 1996.
- [17] Groen, E. L., Jenkin, H. L., and Howard, I. P., “Perception of Self-Tilt in a True and Illusory Vertical Plane,” *Perception*, Vol. 31, No. 12, 2002, pp. 1477–1490.
- [18] Guedry, F. E., “Psychophysics of Vestibular Sensation,” *Handbook of Sensory Physiology, Vol. VI/2: Vestibular System*, edited by H. H. Kornhuber, Springer-Verlag, New York, 1974, Chap. 1.
- [19] Benson, A. J., Spencer, M. B., and Stott, J. R. R., “Thresholds for the Detection of the Direction of Whole-Body, Linear Movement in the Horizontal Plane,” *Aviation, Space, and Environmental Medicine*, Vol. 57, No. 11, 1986, pp. 1088–1096.
- [20] Benson, A. J., Hutt, E. C. B., and Brown, S. F., “Thresholds for the Perception of Whole Body Angular Movement About a Vertical Axis,” *Aviation, Space, and Environmental Medicine*, Vol. 60, No. 3, 1989, pp. 205–213.
- [21] Howard, I. P., “Interactions Within and Between the Spatial Senses,” *Journal of Vestibular Research: Equilibrium and Orientation*, Vol. 7, No. 4, 1977, pp. 311–345.
- [22] Grant, P., and Yam, B., “The Effect of Simulator Motion on Pilot Performance for Helicopter Yaw Tasks,” AIAA Paper CP-2005-6304, 2005.
- [23] Schroeder, J. A., “Helicopter Flight Simulation Motion Platform Requirements,” NASA TP-1999-208766, 1999.
- [24] Wertheim, A. H., Mesland, B. S., and Bles, W., “Cognitive Suppression of Tilt Sensations During Linear Horizontal Ego-Motion in the Dark,” *Perception*, Vol. 30, No. 6, 2001, pp. 733–741.
- [25] Groen, E. L., and Bles, W., “How to Use Body Tilt for the Simulation of Linear Self Motion,” *Journal of Vestibular Research*, Vol. 14, No. 5, 2004, pp. 375–385.
- [26] Harris, L. R., Jenkin, M., and Zikovitz, D. C., “Visual and Non-Visual Cues in the Perception of Linear Self-Motion,” *Experimental Brain Research*, Vol. 135, No. 1, 2000, pp. 12–21.
- [27] Van der Steen, F. A. M., “An Earth-Stationary Perceived Visual Scene During Roll and Yaw Motions in a Flight Simulator,” *Journal of Vestibular Research: Equilibrium and Orientation*, Vol. 8, No. 6, 1998, pp. 411–425.
- [28] Grant, P. R., and Haycock, B., “The Effect of Jerk and Acceleration on the Perception of Motion Strength,” AIAA Paper CP-6253, 2006.
- [29] Berthoz, A., Pavard, B., and Young, L. R., “Perception of Linear Horizontal Self-Motion Induced by Peripheral Vision (Linear Vection),” *Experimental Brain Research*, Vol. 23, No. 5, 1975, pp. 471–489.
- [30] Huang, J., and Young, L. R., “Sensation of Rotation About a Vertical Axis with a Fixed Visual Field in Different Illuminations and in the Dark,” *Experimental Brain Research*, Vol. 41, No. 2, 1981, pp. 172–183.
- [31] Ellerbroek, J., Stroosma, O., Wentink, M., Groen, E. L., and Smaili, M. H., “Effect of Yaw and Sway Motion on Perception and Control: A Multi-Simulator, Follow-Up Study,” AIAA Paper CP-6251, 2006.

This page is intentionally left blank.

NLR

Anthony Fokkerweg 2

1059 CM Amsterdam, The Netherlands

p) +31 88 511 3113 f) +31 88 511 3210

e) info@nlr.nl i) www.nlr.nl