



Dedicated to innovation in aerospace



NLR-TP-2020-484 | April 2021

# Multifunctional fuselage demonstrator: thermoplastic composite skin manufacturing developments

CUSTOMER: JU Clean Sky

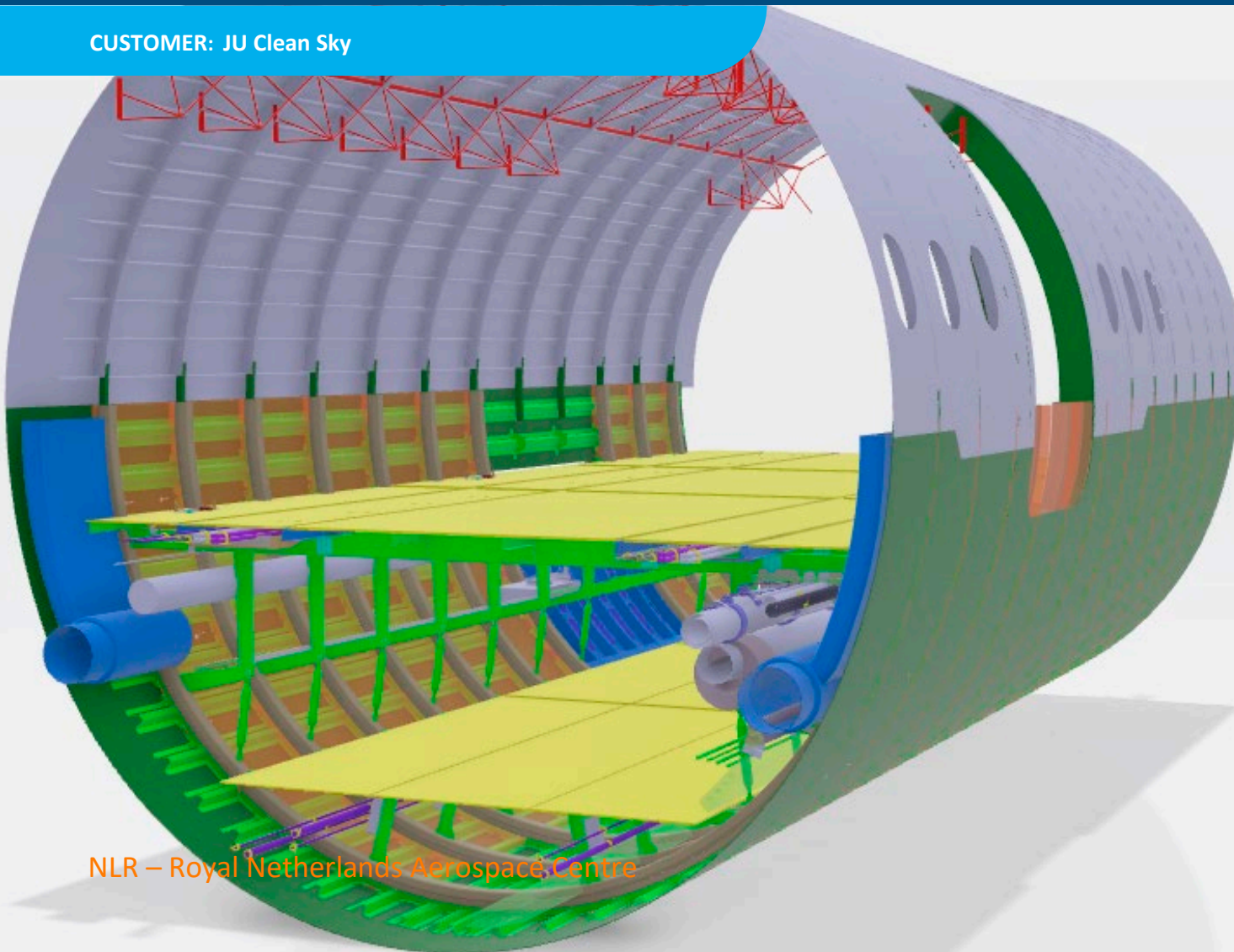

NLR – Royal Netherlands Aerospace Centre

# Multifunctional fuselage demonstrator: thermoplastic composite skin manufacturing developments

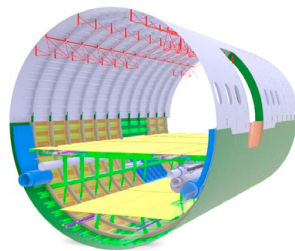

*CAD model of the multifunctional fuselage demonstrator (source: Annex: Clean Sky 11th Call for Proposals – List and Full Description of Topics, 21 November 2019, p. 77)*

## Problem area

Within Clean Sky 2 the design and manufacturing of the fuselage of new single aisle aircraft is investigated through a large, multi-functional fuselage demonstrator, see the figure on the front page. The main objectives of this demonstrator are to enable high production rates and to reduce structural weight and recurring cost. The envisaged demonstrator shall validate high potential multi-functional combinations of airframe structures, systems, cargo and cabin technology concepts for the next generation fuselage and cabin, using advanced materials and innovative design principles.

One of the key innovations for the multi-functional fuselage demonstrator is the modular assembly of pre-equipped sub-assemblies. including components of structures, systems, cabin and cargo. To make a step in the design and manufacturing of such integrated multi-disciplinary fuselage sub-assemblies, advanced materials, manufacturing methods and virtual processing methods are required. Thermoplastic composites, highly automated fibre placement production techniques, and advanced joining methods, offer the flexibility and efficiency that is needed for the production of much more pre-equipped sub-assemblies to enable the modular assembly process for the future aircraft production supply chain.

## REPORT NUMBER

NLR-TP-2020-484

## AUTHOR(S)

W.M. van den Brink  
W.J. Vankan  
J.C. de Kruijk  
S.L. Veldman  
R. Herrmann

## REPORT CLASSIFICATION

UNCLASSIFIED

## DATE

April 2021

## KNOWLEDGE AREA(S)

Aerospace Collaborative  
Engineering and Design

## DESCRIPTOR(S)

Composites  
Thermoplastic  
Stunning  
Fuselage  
FEM

## Description of work

This paper presents a limited exploration and investigation on the development of innovative manufacturing simulation methods for the full-size single aisle skin component for the lower fuselage sub-assembly. Because of the complexity of the skin, the risk for manufacturing of the demonstrator skin, and the level of detail that is required for high manufacturing accuracy, detailed 3D modelling and analyses are necessary for predictions of the manufacturing processes and the resulting product.

## Results and conclusions

The presented modelling steps for manufacturing of the thermoplastic skin part are the laminate conversion from CAD, the fibre placement manufacturing simulation, and the dynamic handling of the thin skin section and draping process in Abaqus. The simulation results have given valuable insight in the behaviour. This insight is used for improving the manufacturing of multi-functional structures and for obtaining first time right parts.

## Applicability

The technologies presented are broadly applicable to composite structures. The technologies are specifically applied for the preparation of the manufacturing of the thermoplastic skin of the lower fuselage assembly, which is made by the STUNNING consortium under the lead of GKN-Fokker for the Clean Sky 2 Multifunctional Fuselage Demonstrator.

### GENERAL NOTE

This report is based on a presentation held at the EMuS conference, virtual, 17 November 2020.

### NLR

Anthony Fokkerweg 2

1059 CM Amsterdam, The Netherlands

p ) +31 88 511 3113

e ) [info@nlr.nl](mailto:info@nlr.nl) i ) [www.nlr.nl](http://www.nlr.nl)



Dedicated to innovation in aerospace

NLR-TP-2020-484 | April 2021

# Multifunctional fuselage demonstrator: thermoplastic composite skin manufacturing developments

CUSTOMER: JU Clean Sky

## AUTHOR(S):

**W.M. van den Brink**  
**W.J. Vankan**  
**J.C. de Kruijk**  
**S.L. Veldman**  
**R. Herrmann**

NLR  
NLR  
NLR  
GKN-Fokker  
Airbus

This report is based on a presentation held at the EMuS conference, virtual, 17 November 2020.

*The contents of this report may be cited on condition that full credit is given to NLR and the authors.  
This publication has been refereed by the Advisory Committee AEROSPACE VEHICLES (AV).*

|                                |                    |
|--------------------------------|--------------------|
| <b>CUSTOMER</b>                | JU Clean Sky       |
| <b>CONTRACT NUMBER</b>         | 807097, 945583     |
| <b>OWNER</b>                   | NLR + partner(s)   |
| <b>DIVISION NLR</b>            | Aerospace Vehicles |
| <b>DISTRIBUTION</b>            | Unlimited          |
| <b>CLASSIFICATION OF TITLE</b> | UNCLASSIFIED       |

| <b>APPROVED BY:</b>        |                    | <b>Date</b> |
|----------------------------|--------------------|-------------|
| <b>AUTHOR</b>              | W.M. van den Brink | 12-04-2021  |
| <b>REVIEWER</b>            | J. Kos             | 12-04-2021  |
| <b>MANAGING DEPARTMENT</b> | A.A. ten Dam       | 13-04-2021  |

## Summary

Within Clean Sky 2 the design and manufacturing of the fuselage of new single aisle aircraft is investigated through a large, multi-functional fuselage demonstrator. The main objectives of this demonstrator are to enable high production rates with a minimum of 60 aircraft per month and to reduce structural weight and recurring cost. The envisaged demonstrator shall validate high potential multi-functional combinations of airframe structures, systems, cargo and cabin technology concepts for the next generation fuselage and cabin, using advanced materials and innovative design principles.

One of the key innovations for the multi-functional fuselage demonstrator is the modular assembly of pre-equipped sub-assemblies, see reference [1] and [4]. To make a step in the design and manufacturing of such integrated multi-disciplinary fuselage sub-assemblies, including components of structures, systems, cabin and cargo, advanced materials and manufacturing methods are required. Thermoplastic composites and their highly automated fibre placement production techniques and advanced joining methods, offer the flexibility and efficiency that is needed for the production of much more pre-equipped sub-assemblies to enable the modular assembly process for the future aircraft production supply chain.

This paper presents a limited exploration and investigation on the development of innovative manufacturing simulation methods for the full-scale single aisle skin component for the lower fuselage. Because of the complexity of the considered multi-functional structures, the risk for manufacturing of the demonstrator and the level of detail that is required for the high level of manufacturing accuracy, detailed 3D modelling and analyses are necessary for predictions of the manufacturing processes.

The presented modelling steps for manufacturing of the thermoplastic skin part are the laminate conversion from CAD (composite modeller), the fibre placement manufacturing simulation (explicit), and the dynamic handling of the thin skin section and draping process (implicit and explicit simulations). The simulation results have given valuable insight in the behaviour. This insight is used for improving the manufacturing of multi-functional structures and obtain first time right parts.

# Contents

|  |           |
|--|-----------|
| <b>Abbreviations</b>                           | <b>5</b>  |
| <b>1 Abstract</b>                              | <b>6</b>  |
| <b>2 Introduction</b>                          | <b>7</b>  |
| <b>3 Methods and models</b>                    | <b>8</b>  |
| 3.1 Composite modeller                         | 8         |
| 3.2 Fibre placement simulation                 | 8         |
| 3.3 Handling simulation and draping simulation | 9         |
| <b>4 Results</b>                               | <b>10</b> |
| 4.1 Composite modeller                         | 10        |
| 4.2 Fibre placement simulation                 | 10        |
| 4.3 Handling simulation and draping simulation | 11        |
| <b>5 Conclusions and recommendations</b>       | <b>13</b> |
| <b>6 References</b>                            | <b>14</b> |

# Abbreviations

| ACRONYM | DESCRIPTION                        |
|---------|------------------------------------|
| AFP     | Automated Fibre Placement          |
| CAD     | Computer Aided Design              |
| CAE     | Computer Aided Engineering         |
| CPU     | Central Processing Unit            |
| FPM     | Fibre Placement Manufacturing      |
| HRP     | High Rate Production               |
| NLR     | Royal Netherlands Aerospace Centre |
| S4R     | Shell element Abaqus               |



# 1 Abstract

Within Clean Sky 2 the design and manufacturing of the fuselage of new single aisle aircraft is investigated through a large, multi-functional fuselage demonstrator, see Figure 1. The main objectives of this demonstrator are to enable high production rates with a minimum of 60 aircraft per month and to reduce structural weight and recurring cost. The envisaged demonstrator shall validate high potential multi-functional combinations of airframe structures, systems, cargo and cabin technology concepts for the next generation fuselage and cabin, using advanced materials and innovative design principles.

One of the key innovations for the multi-functional fuselage demonstrator is the modular assembly of pre-equipped sub-assemblies, see reference [1] and [4]. To make a step in the design and manufacturing of such integrated multi-disciplinary fuselage sub-assemblies, including components of structures, systems, cabin and cargo, advanced materials and manufacturing methods are required. Thermoplastic composites and their highly automated fibre placement production techniques and advanced joining methods, offer the flexibility and efficiency that is needed for the production of much more pre-equipped sub-assemblies to enable the modular assembly process for the future aircraft production supply chain.

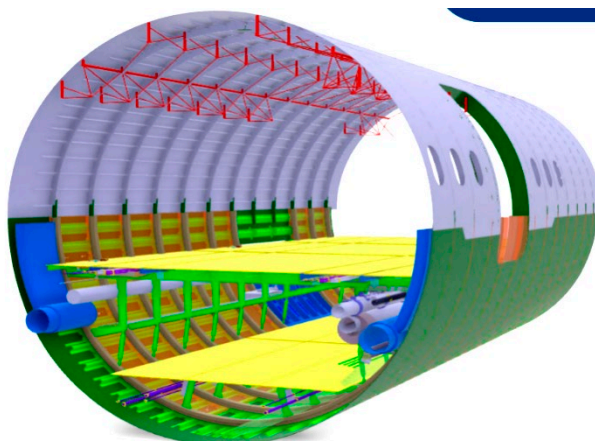

Figure 1: CAD model of the full fuselage (source: Annex: Clean Sky 11th Call for Proposals – List and Full Description of Topics, 21 November 2019, p. 77)

This paper presents investigations on the exploration and development of innovative manufacturing simulation methods for the full-scale single aisle skin component for the lower fuselage. Because of the complexity of the considered multi-functional structures, the risk for manufacturing of the demonstrator and the level of detail that is required for the high level of manufacturing accuracy, detailed 3D modelling and analyses are necessary for predictions of the manufacturing processes. The results presented in the paper will include the modelling steps for manufacturing of the thermoplastic skin part from the laminate conversion from CAD (composite modeller) to automated fibre placement manufacturing simulation (explicit) and dynamic handling of the thin skin section and draping process (implicit and explicit simulations). The modelling results support the specification of manufacturing tools and processes, which are currently further developed.

## 2 Introduction

To deliver a double-digit fuel burn reduction for the Large Passenger Aircraft (LPA) segment next generation fuselage structure concepts are needed in which cabin, cargo and physical system elements are integrated. The three main overarching objectives for future fully equipped Single Aisle Aircraft fuselages compared to the state of the art are:

- Enable a High Rate Production (HRP) of minimum 60 shipsets per month
- Reduce a total fuselage weight by 10%
- Reduce the recurring cost by 20%

For this purpose a full scale fuselage section will be developed, manufactured and delivered as manufacturing demonstrator. The lower half of this section is 180° full scale multi-functional integrated thermoplastic fuselage shell, incl. cabin and cargo floor structure and relevant main interior and system elements. Advanced design principles, innovative system architecture, advanced materials and processes to generate high potential solutions for next generation fuselages will be used. One of these advanced design principles enabling the multifunctional structures is the use of virtual process technologies.

During the last five years the virtual process simulations (also known as manufacturing simulation, virtual manufacturing) using physical behaviour has received increased attention. The benefit of virtual process simulations are to gain insight in the behaviour and influence of process parameters, before the actual manufacturing, thus reducing the risk by mitigating actions. Manufacturing experience, trials, and small size demonstrators can therefore be assisted by powerful simulation tools. An overview of virtual processing tools is shown in references [2], [3] and [5].

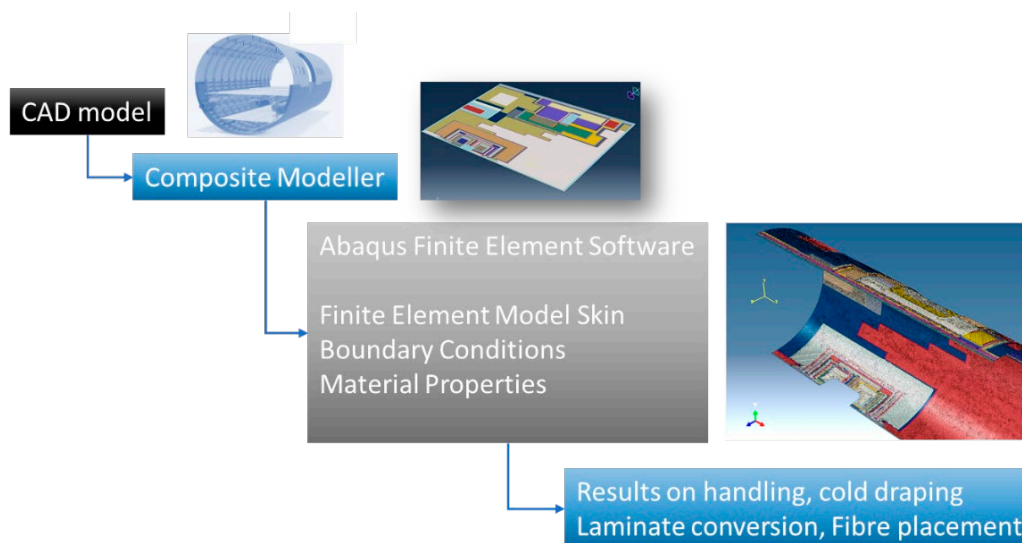

Figure 2: Workflow from CAD model to Finite Element Analyses results

Manufacturing methods used for the full-scale single aisle fuselage skin component are investigated for support by virtual processing simulation, see Figure 2. Because of the complexity of the considered large multi-functional structures, the risk for industrial manufacturing and for the manufacturing of the demonstrator, and the level of detail that is required for the high level of manufacturing accuracy, detailed 3D modelling and analyses are necessary for predictions of the manufacturing processes. The results presented in the paper will include the modelling steps for manufacturing of the thermoplastic skin part from the laminate conversion from CAD (composite modeller) to automated fibre placement manufacturing simulation (explicit) and dynamic handling of the thin skin section and draping process (implicit and explicit simulations).

## 3 Methods and models

In this section of the paper the methods used to enable multifunctional structures will be presented. The topics are composite modeller, handling simulation and draping and fibre placement simulations.

### 3.1 Composite modeller

The composite skin consists of many layers and ply drops that are defined in the CAD files (Catia). Correct transfer of geometrical and composite data into the finite element software can be very challenging. Furthermore the detailed translation from the curved fuselage skin defined in CAD to the flat skin model needed for the manufacturing simulation introduces additional challenges. Therefore the fibre orientation of the layer and normal directions of the laminate need to be accounted for. To perform this translation the composite modeller is used which has the beforementioned mapping with high accuracy. Composites Modeler for Abaqus/CAE extends the ply modelling features in Abaqus by providing fibre simulation capabilities.

### 3.2 Fibre placement simulation

The composite layer deposition is performed using a fibre placement machine, also known as advanced fibre placement AFP. To gain insight in the behaviour and dynamics of this production process a simulation using dynamic explicit is performed on the fibre placement. This approach allows for assessing the design space using a DOE, e.g. influence of tackiness to the mould, bending and cutting using material damage parameters of the composite fibres/tows in an efficient way. The virtual fibre placement head can deposit 8 composite tows simultaneously. In contrast to most AFP simulations this included the physical effects. This type of simulation is useful for fibre placement of complex geometries or with fibre steering, which potentially have wrinkles. Qualitative comparison of this technology has been performed and up to now no full validation.

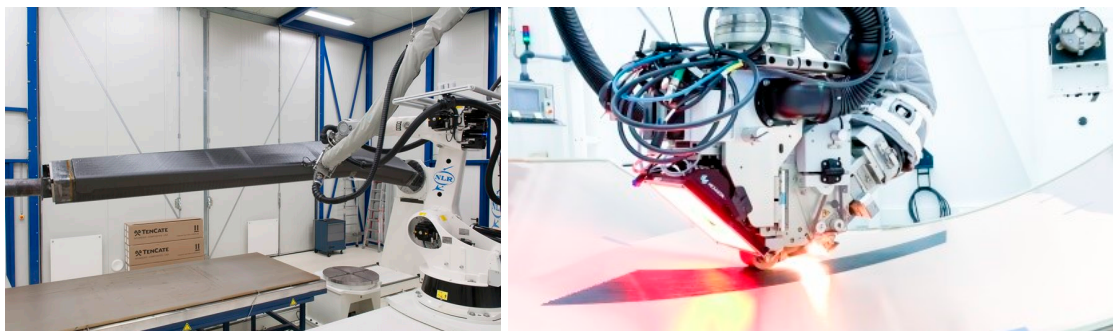

Figure 3: Fibre placement technology which is used for the manufacturing of the skin. [6, 7]

### 3.3 Handling simulation and draping simulation

The manufacturing process foreseen for the large skin section includes the handling and draping of several sub-laminates into the consolidation mould. To gain insight in the dynamic behaviour of these quite large and thin and flexible skin sub-laminate structures, dynamic explicit simulations are performed. This simulation extends experience from practical tests on a small size panel near the door surround to the full size skin. The skin is picked up using suction cups and then carefully placed into the curved mould.

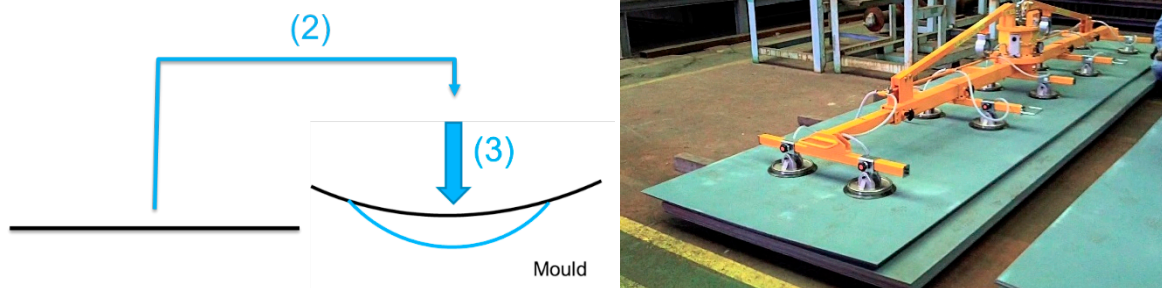

Figure 4: Schematic of the skin after fibre placement to the mould involving a shape transition from flat to curved and on the right an image of a vacuum lifting device [8]

The method used for modelling enables variation of laminate thickness, number of suction cups and their distribution over the skin. The main aim of these simulations is to analyse in detail behaviour of these large and thin laminates during the transition to avoid that the skin gets damaged during this transport to the mould. Also the behaviour of the thicker door surround sub-laminate could be investigated. The requirements are set on maximum suction cup load is 200 N and interlaminar shear stress (ILSS) due to bending of the preform laminate of 6 MPa. The handling and draping simulation has not been validated yet. The input such as suction cups load have been tested.

## 4 Results

In this section the results for the several topics related to the manufacturing of the multifunctional fuselage demonstrator skin is discussed.

### 4.1 Composite modeller

As described in section 2.1 the composite modeller is used for creating the skin finite element model. The ply book design of the skin for the demonstrator contains over 120 detailed ply definitions. These definitions are active in different regions over the skin in order to create a balanced and as-designed skin. To do this manually would be too big an effort so therefore the composite modeller is used. This uses the CAD Catia file and Abaqus finite element mesh as input to map the laminate to the mesh. Two designs were made, a coarse design with 50.000 elements and one with 500.000 elements (S4R shells). For the second design also the mesh was more structured to enable correct mapping of the ramp zone details using elements with average size of 10 mm.

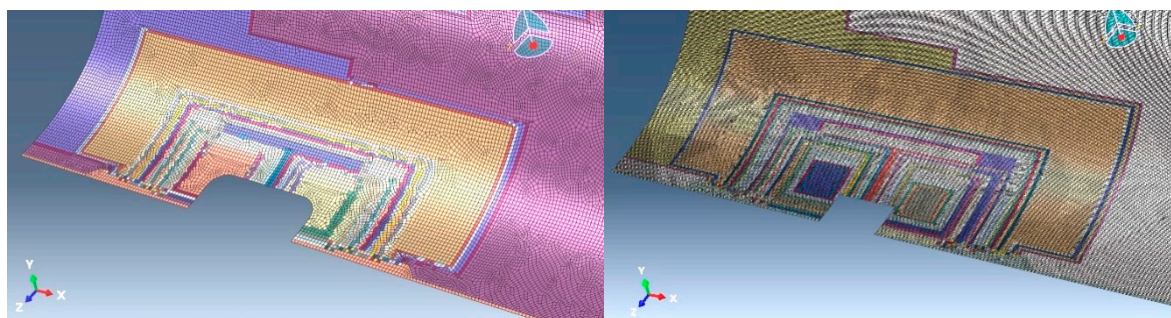

Figure 5: Composite modeller mapping of the skin

The mapping of the laminate from CAD to the finite element model was performed successfully. The overall computational performance proved to be challenging due to the large amount of ply definitions and sections. The result of the mapped finite element skin model was used for the handling and draping simulations described in section 3.3.

### 4.2 Fibre placement simulation

As described in section 2.2 the fibre placement simulation is used. For the manufacturing of the skin the fibre placement manufacturing is used. In order to gain understanding of the process a simulation was created using Abaqus Explicit, so-called virtual FPM. This consists of the following parts, which are shown in see Figure 6: the metal mould (white), the fibre placement head and tow guides (blue), the individual tows (8 in total), cutting knives, roller (blue). The mould, cutting knives and fibre placement head are rigid parts. The carbon fibre reinforced plastic tows are elastic and have damage modelling and cohesive interaction (tack) with the mould. The roller is also elastic with rubber properties.

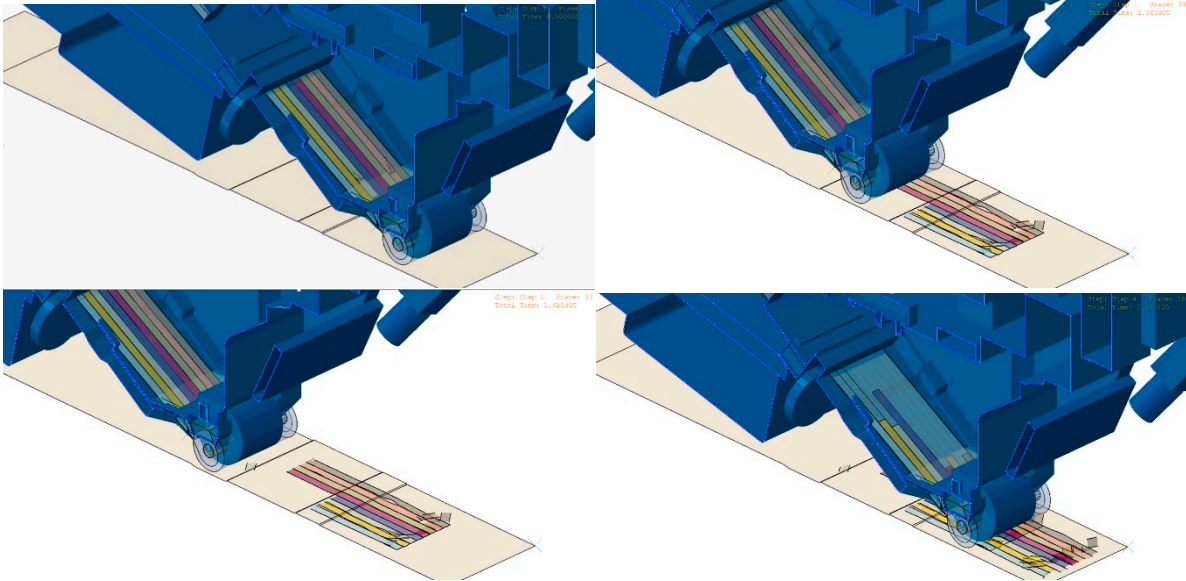

Figure 6: Fibre placement simulation (Virtual FPM)

The results of the simulation are shown Figure 6 where two layers are deposited using the intermediate cutting. The simulation results are satisfying in a qualitative respect with good correspondence with fibre placement tow behaviour in reality using visual comparison. The computational effort is significant with 2 hours of calculation time on 8 CPU's. It gives valuable insight in the sensitivities and speed of the process. The approach will be used for the skin to investigate challenging areas. At this point it is not feasible to have the entire skin part simulated using this approach because of computational limitation. Further work also involves the combination with thermal simulation and laser heating followed by a cooldown distortion simulation and validation using actual measurements.

### 4.3 Handling simulation and draping simulation

As described in section 2.3 the manufacturing process foreseen for the large lower skin of the demonstrator includes several fibre placed sub-laminates, handling and draping into the consolidation mould, see Figure 7. Several models are created with different suction cup supports. The thinnest -and therefore the most flexible- skin sub-laminate is selected as worst case for the analyses and consists of 6 plies.

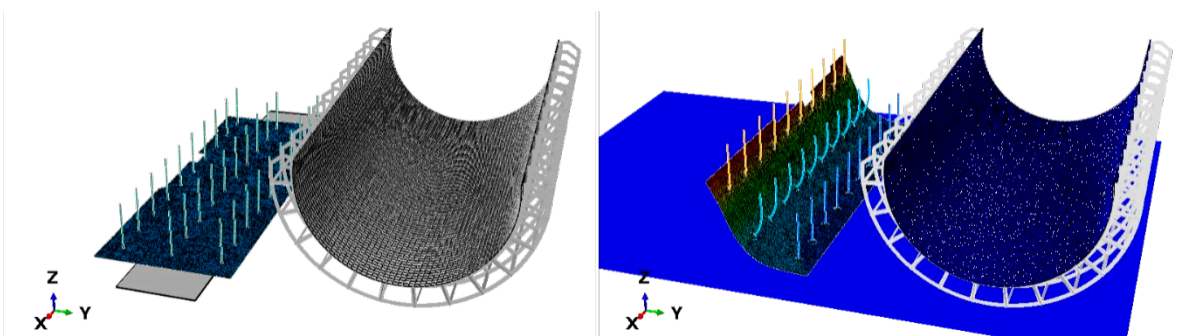

Figure 7: Model and result of the skin transport using suction cups. On the left in blue the flat placed skin and the curved mould. On the right the pick up of the flat skin using suction cups and chains towards the mould

The dynamic handling and draping finite element simulation gives very good insight in the behaviour of the flexible thermoplastic skin. Too little supporting suction cups will give considerable bending and interlaminar shear stress, high suction cup loading and possible damage to the unconsolidated thermoplastic skin. A suction cup arrangement of 3 x 10 gives satisfactory results and normal and shear loading of the suction cups within the safety limits of 200 N loading. Also the bending is limited and shows low ILSS values of 1 – 2.4 MPa. This option is chosen for the manufacturing and transport process.

## 5 Conclusions and recommendations

In this paper the exploration and investigation on the development of innovative manufacturing simulation methods for the full-scale single aisle fuselage skin component are presented. The complexity of the envisaged multi-functional structures has benefits but also poses a risk for both the industrial manufacturing and the manufacturing of the demonstrator and increases the level of detail that is required for the high level of manufacturing accuracy. Therefore the detailed 3D modelling and analyses are necessary for risk-mitigating predictions of the manufacturing processes.

The presented modelling steps for manufacturing of the thermoplastic skin part are the laminate conversion from CAD (composite modeller), the fibre placement manufacturing simulation (explicit), and the dynamic handling of the thin skin section and draping process (implicit and explicit simulations). The simulation results have given valuable insight in the behaviour. This insight is used for improving the manufacturing of multi-functional structures and obtain first time right parts.

### ACKNOWLEDGEMENT

This project has received funding from the Clean Sky 2 Joint Undertaking (JU) under grant agreements Nos 807097 and 945583. The JU receives support from the European Union's Horizon 2020 research and innovation programme and the Clean Sky 2 JU members other than the Union.

*The work and support of C.P. Groenendijk from NLR is kindly acknowledged.*



### DISCLAIMER

The results, opinions, conclusions, etc. presented in this work are those of the author(s) only and do not necessarily represent the position of the JU; the JU is not responsible for any use made of the information contained herein.



## 6 References

- [1] S.L. Veldman, P.J. Kortbeek, P.C. Wölcken, R. Herrmann, J. Kos, I. Fernandez Villegas, Development of a multifunctional fuselage demonstrator, Proceedings of Aerospace Europe Conference, Bordeaux, France, 25 February 2020 to 28 February 2020
- [2] D. Otten, T.A. Weber, J.C. Arent, Manufacturing Process Simulation – On Its Way to Industrial Application, International Journal of Aviation, Aeronautics, and Aerospace Volume 5 Issue 2
- [3] Dörr, Dominik & Brymerski, Wojciech & Ropers, Steffen & Leutz, D. & Joppich, T. & Kärger, Luise & Henning, Frank. (2017). A Benchmark Study of Finite Element Codes for Forming Simulation of Thermoplastic UD-Tapes. Procedia CIRP. 66. 101-106. 10.1016/j.procir.2017.03.223
- [4] W.M. van den Brink, J. Kos, W.J. Vankan, A.J. de Wit, Large carbon fibre reinforced thermoplastic fuselage manufacturing supported by virtual processing, NLR-TP-2020-393, 7th Aircraft Structural Design Conference, 2020
- [5] L. Paletti, W.M. van den Brink, Virtual manufacturing for composites, overview and status, Presented at the ISCM 2018, November 2018, Marknesse, Netherlands, NLR-TP-2019-367
- [6] Website: <https://www.compositesworld.com/articles/thermoplastic-composite-demonstrators-eu-roadmap-for-future-airframes->, G. Gardiner, Thermoplastic composite demonstrators - EU roadmap for future airframes
- [7] Website: <https://www.sucohs-project.eu/news/sucohs-newsletter-no-3>, SUCOHS EU project newsletter 3
- [8] Website: <https://www.vacuumlift.jp/eng/vac/m6075.html>, VD M-6075 Fukoku Corp. Japan



Dedicated to innovation in aerospace

## NLR - Royal Netherlands Aerospace Centre

Royal NLR operates as an unaffiliated research centre, working with its partners towards a better world tomorrow. As part of that, Royal NLR offers innovative solutions and technical expertise, creating a strong competitive position for the commercial sector.

Royal NLR has been a centre of expertise for over a century now, with a deep-seated desire to keep innovating. It is an organisation that works to achieve sustainable, safe, efficient and effective aerospace operations.

The combination of in-depth insights into customers' needs, multidisciplinary expertise and state-of-the-art research facilities makes rapid innovation possible. Both domestically and abroad, Royal NLR plays a pivotal role between science, the commercial sector and governmental authorities, bridging the gap between fundamental research and practical applications. Additionally, Royal NLR is one of the large technological institutes (GTIs) that have been collaborating since 2010 in the Netherlands on applied research as part of the TO2 federation.

From its main offices in Amsterdam and Marknesse plus two satellite offices, Royal NLR helps to create a safe and sustainable society. It works with partners on numerous (defence) programmes, including work on complex composite structures for commercial aircraft and on goal-oriented use of the F-35 fighter. Additionally, Royal NLR helps to achieve both Dutch and European goals and climate objectives in line with the Luchtvaartnota (Aviation Policy Document), the European Green Deal and Flightpath 2050, and by participating in programs such as Clean Sky and SESAR.

For more information visit: [www.nlr.org](http://www.nlr.org)

### Postal address

PO Box 90502  
1006 BM Amsterdam, The Netherlands  
e) [info@nlr.nl](mailto:info@nlr.nl) i) [www.nlr.org](http://www.nlr.org)

### NLR Amsterdam

Anthony Fokkerweg 2  
1059 CM Amsterdam, The Netherlands  
p) +31 88 511 3113

### NLR Marknesse

Voorsterweg 31  
8316 PR Marknesse, The Netherlands  
p) +31 88 511 4444