



NLR-TP-2013-316

Metal additive manufacturing of a high-pressure micro-pump

J. van Es, W. Wits and S.J. Weitkamp

Nationaal Lucht- en Ruimtevaartlaboratorium

National Aerospace Laboratory NLR

Anthony Fokkerweg 2

P.O. Box 90502

1006 BM Amsterdam

The Netherlands

Telephone +31 (0)88 511 31 13

Fax +31 (0)88 511 32 10

Web site: <http://www.nlr.nl>



Executive summary

Metal additive manufacturing of a high-pressure micro-pump

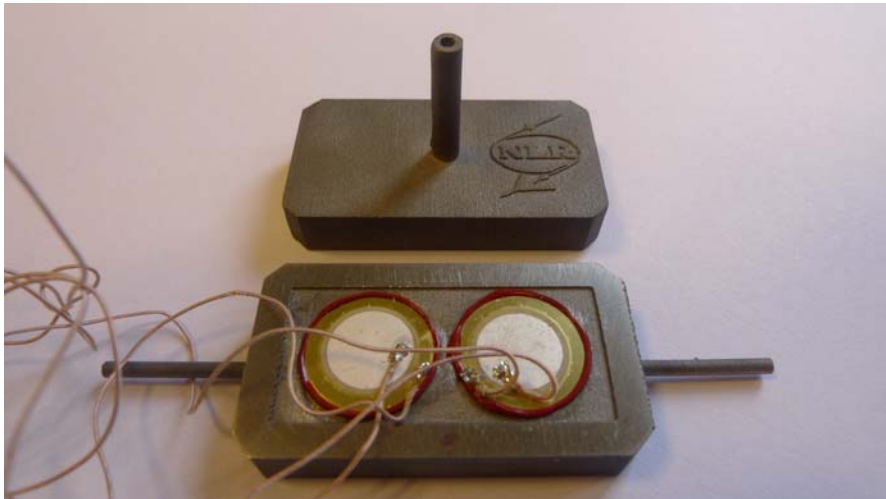

Report no.

NLR-TP-2013-316

Author(s)

J. van Es
W. Wits
S.J. Weitkamp

Report classification

UNCLASSIFIED

Date

July 2013

Knowledge area(s)

Ruimtevaarttoepassingen
Constructie- en
fabricagetechnologie

Descriptor(s)

Prototypes
Cooling Systems
Manufacturing

Problem area

For the thermal control of future space applications pumped two-phase loops are an essential part to handle the increasing thermal power densities. This study investigates the design of a reliable, leak tight, low-weight and high-pressure micro-pump for small satellite applications. The developed micro-pump uses a piezoelectric disk to create a pressure head and propel the working fluid.

Description of work

The micro-pumps are produced from Titanium alloy (Ti6Al4V) using Selective Laser Melting (SLM) as a metal additive manufacturing technique. Two types of micro-valve designs are explored, namely (1) no moving parts valves and (2) passive check valves.

Results and conclusions

Experimental validation shows promising results especially for micro-pumps using passive check micro-valves. Finally, the assembly of the entire micro-pump has been designed for SLM production. In the end, this would enable the future use of micropumps for space applications.

Applicability

Metal additive manufacturing, as relatively new manufacturing system, shows promising results for both research work and final production.

CIRP Conference

This report is based on a paper presented at the Forty Sixth CIRP Conference on Manufacturing Systems, in Sétubla, Portugal 29-31 May 2013.

This report is based on a paper presented at the Forty Sixth CIRP Conference on Manufacturing Systems, in Sétubla, Portugal, May 29-31, 2013.



NLR-TP-2013-316

Metal additive manufacturing of a high-pressure micro-pump

J. van Es, W. Wits¹ and S.J. Weitkamp¹

¹ Faculty of Engineering Technology, University of Twente

This report is based on a paper presented at the Forty Sixth CIRP Conference on Manufacturing Systems, in Sétubla, Portugal 29-31 May 2013.

The contents of this report may be cited on condition that full credit is given to NLR and the authors. This publication has been refereed by the Advisory Committee AEROSPACE SYSTEMS.

Customer National Aerospace Laboratory NLR
Contract number -----
Owner National Aerospace Laboratory NLR
Division NLR Aerospace Systems
Distribution Unlimited
Classification of title Unclassified
July 2013

Approved by:

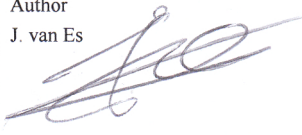
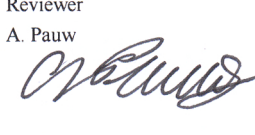
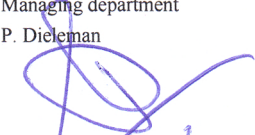
Author J. van Es 	Reviewer A. Pauw 	Managing department P. Dieleman 
Date: 22/07/2013	Date: 22/07/2013	Date: 29/7/2013

Contents

Abstract	3
1 Introduction	3
1.1 Research goal	3
1.2 Outline	4
2 Micro-pump background	4
2.1 Bartels mp6 micro-pump redesign	4
3 Metal additive manufacturing	5
4 Micro-pump valve design	5
4.1 No moving parts micro-valve	5
4.2 Passive check micro-valve	6
5 Final micro-pump design	8
6 Conclusions	8
Acknowledgements	8
References	8



Metal additive manufacturing of a high-pressure micro-pump

Wessel W. Wits^{a,*}, Sander J. Weitkamp^a, Johannes van Es^b

^aUniversity of Twente, Faculty of Engineering Technology, P.O. Box 217, 7500AE, Enschede, The Netherlands

^bDutch National Aerospace Laboratory, P.O. Box 153, 8300AD, Emmeloord, The Netherlands

* Corresponding author. Tel.: +31 53 489 2266; fax: +31 53 489 3631; E-mail address: w.w.wits@utwente.nl.

Abstract

For the thermal control of future space applications pumped two-phase loops are an essential part to handle the increasing thermal power densities. This study investigates the design of a reliable, leak tight, low-weight and high-pressure micro-pump for small satellite applications. The developed micro-pump uses a piezoelectric disk to create a pressure head and propel the working fluid. The micro-pumps are produced from Titanium alloy (Ti6Al4V) using Selective Laser Melting (SLM) as a metal additive manufacturing technique. Two types of micro-valve designs are explored, namely (1) no moving parts valves and (2) passive check valves. Experimental validation shows promising results especially for micro-pumps using passive check micro-valves. Finally, the assembly of the entire micro-pump has been designed for SLM production. In the end, this would enable the future use of micro-pumps for space applications. Metal additive manufacturing, as relatively new manufacturing system, showcases promising results for both research work and final production.

© 2013 The Authors. Published by Elsevier B.V.

Selection and peer-review under responsibility of Professor Pedro Filipe do Carmo Cunha

Keywords: Micro-pump; Micro-valve; Two-phase cooling; Metal additive manufacturing; Selective laser melting

1. Introduction

Since the first satellite (Sputnik 1) was launched in 1957, space is filling up with satellites. Currently there are more than 6,500 satellites increasing continuously [1]. The thermal control of onboard electronics plays an important role during the satellite design process. With the ongoing miniaturization of electronic components and increasing performance demands, the European Space Agency (ESA) expects the thermal power density to reach 50-300 W/m² in the near future [2].

To cope with these high power densities, different cooling devices can be used. The general mechanism that is applied however uses a two-phase cycle, for instance heat pipes or loop heat pipes. The advantage of these devices is that they are passive; i.e. they do not require an external pump, nor electric power to function. This also makes them very reliable and cost effective.

A passive two-phase loop is however not capable of reaching the ESA expected power densities [3]. Hence, pumped two-phase loops are forecasted to replace their passive counterparts. To enable the space application of

pumped loops, two main hurdles must first be overcome; namely reliability and mass reduction.

1.1. Research goal

The goal of this research is to develop a micro-pump to operate a two-phase cooling loop for small satellite applications. Micro-pumps for terrestrial applications are already commercially available; however, these do not meet the stringent requirements for space applications. Hence, a ruggedization of micro-pumps is required.

The target lifetime (reliability demand) is at least 23 years and the targeted mass budget is 2g per Watt of dissipated power excluding pump electronics. For small satellite electronics where about 100W needs to be dissipated, this results in a total mass budget of 200g.

Two-phase cooling loops are pressurized depending on the working fluid and operating temperature. The maximum working pressure for the micro-pump in question is 60bar, which would allow it to be used in a CO₂ cooling loop. The required flow rate for a single micro-pump is 5ml/min. Finally, the micro-pump must be 100% leak tight.

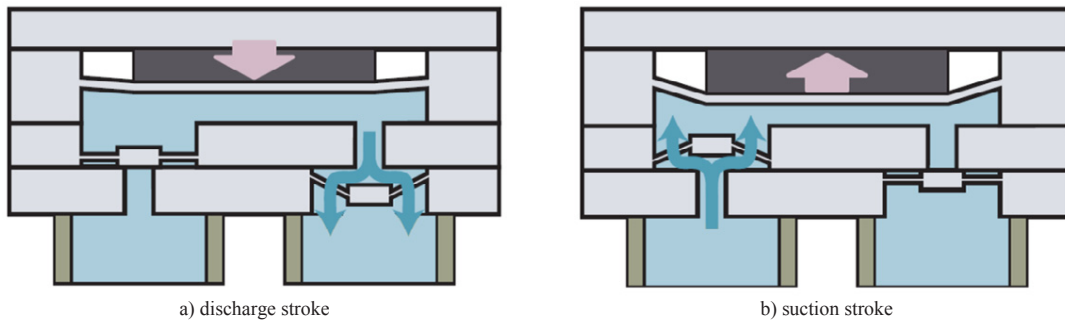

Figure 1: Mechanical micro-pump with reciprocating diaphragm motion

1.2. Outline

This paper is structured as follows. First a short background is presented on micro-pumps in general, including a commercially available plastic version of the envisioned micro-pump. In Section 3 the chosen production method (i.e. selective laser melting) and the chosen material for the micro-pump design are discussed. Section 4 presents the valve design for the micro-pump, including experimental results. Section 5 illustrates the final design of the envisioned micro-pump. Finally, Section 6 presents the conclusions of this paper.

2. Micro-pump background

Even though the application of a micro-pump is new for space applications, the micro-pump itself was first patented in 1975 [4] and is widely used nowadays; for instance, for micro-electrical mechanical systems (MEMS) or medical applications. Laser et al. [5] have classified the micro-pump according to two categories: (1) mechanical and (2) non-mechanical. The former uses moving parts for actuation, whereas the latter (often) uses a chemical process as driving force. Most of the mechanical micro-pumps are reciprocating (i.e. oscillating) pumps developed for water as working fluid.

Figure 1 illustrates a typical mechanical micro-pump design using a reciprocating diaphragm motion. The figure shows a single pump chamber filled with fluid. The chamber is connected with an inlet tube and an outlet tube. Between the pump chamber and both tubes check valves are positioned. On the topside of the pump chamber a diaphragm is placed. This diaphragm is actuated, for instance with a piezo actuator thereby changing the volume of the fluid chamber.

Figure 1(a) illustrates the discharge stroke in which the diaphragm is deformed downwards causing the chamber volume to decrease. The resulting fluid pressure increase pushes both check valves down. This closes the inlet tube and forces fluid to exit through the outlet tube. In Figure 1(b) the opposite, a suction stroke, is shown in which (new) fluid is sucked into the pump.

2.1. Bartels mp6 micro-pump redesign

For this research, the Bartels mp6 [6] micro-pump is used as a starting point. This is a commercially available pump with two pump chambers in series. This micro-pump is used for low capacity applications as insulin pumps or lubrication systems. Figure 2 shows an exploded view of this micro-pump.

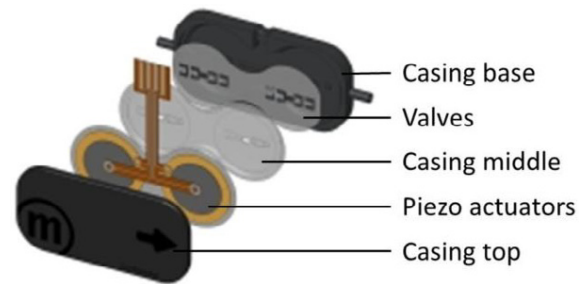

Figure 2: Bartels mp6 micro-pump [6]; exploded view.

The Bartels mp6 micro-pump is actuated by two piezoelectric disks. Figure 3 shows the piezo disks in blue deflecting the purple diaphragms. The micro-valves (red) are passive, polymeric check valves that open and close due to the pressure difference. In this case, the valves operate differently than in Figure 1; however, the principle is the same.

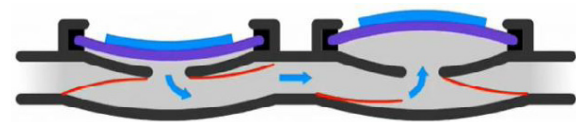

Figure 3: Bartels mp6 micro-pump [6]; two pump chambers in series.

Due to the working pressure and hermetic requirements of the intended micro-pump, elastomeric alloys (e.g. plastics) as a construction material are not possible. In order to quickly test possible micro-pump designs, metal additive manufacturing is selected as the production method.

3. Metal additive manufacturing

Additive Manufacturing (AM) is a relatively new type of production technology. AM processes generally build a 3D structure in a layered approach. Features are produced by fusing raw material, usually a fine powder, layer by layer, stacking layers until the full 3D part is ready. This is illustrated in Figure 4. Loose powder is rolled from the powder supply side to the part build area. Here, the powder is fused where needed, for instance by a laser beam, using the part's computer (CAD) model. After producing a layer, a new layer of loose powder is rolled onto the previous. This cycle continues until the complete (end-)part is produced.

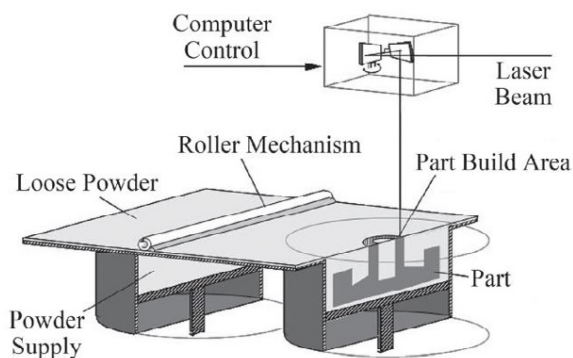

Figure 4: Exemplary additive manufacturing process: Selective Laser Sintering (SLS) [7].

The unique processing features of AM allow engineers to design parts with functional features impossible to make otherwise. This is shown in Figure 5, where a 3D part with a complex outer functional geometry and an internal open support structure, for instance to reduce weight, is shown. With AM such a part can be produced in one operation without the need for multiple sequential manufacturing steps.

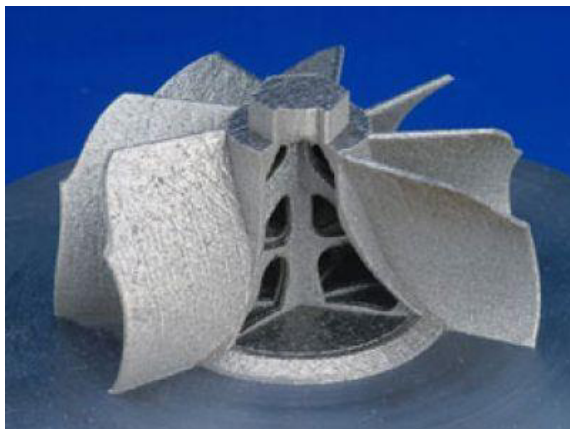

Figure 5: Example of a complex AM part impossible to produce otherwise [8].

To reach 100% leak tightness, sintering is not sufficient and Selective Laser Melting (SLM) of metal particles is chosen as metal AM production technique. Titanium alloy Grade 5 (i.e. Ti6Al4V) is chosen as base material, because of its relative low density (low weight), corrosion resistance and good processability for SLM [9-12].

The ability to quickly produce complex internal structures is used to test parts of the micro-pump design directly in an experimental setting.

4. Micro-pump valve design

For the micro-pump valves ideally fluid is allowed to pass in the forward motion, but it is obstructed in the backward motion. Leakage caused by the valves causes an inefficiency of the entire micro-pump. Leakage free or low leakage valves are usually active valves in which an actuator controls the valve direction. These additional actuators decrease reliability, and increase cost and complexity; therefore, in this case a passive system is preferred. Passive means that the fluid motion controls the valve's closure.

According to Kwang et al. [13] passive valves can be subdivided into two categories: (1) No Moving Parts (NMP) valves and (2) passive check valves. NMP valves are fixed-geometry valves that inhibit backward flow by fluidic forces instead of moving parts. Check valves typically are thin cantilever shaped constructions in which the fluid motion deforms the thin construction, similar to a spring, to obstruct backward flow.

4.1. No moving parts micro-valve

The first type of NMP valve is the Tesla micro-valve [14]. Figure 6 shows three types of micro-valves: a traditional Tesla valve – the T4530 in Figure 6(a) – and two numerically optimized micro-valves, Figures 6(b-c), for a flow of 30 and 100 Reynolds, respectively. All three micro-valves allow fluid to pass from left to right. In the other direction (i.e. right to left) the fluid flow is diverted to encounter itself and thus inhibiting backward flow. These types of micro-valves are quite common for MEMS devices to move very small quantities of fluid within the device.

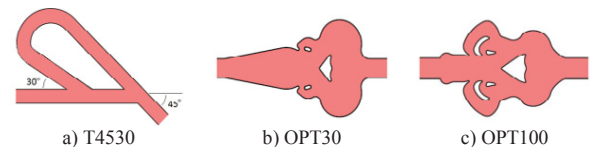

Figure 6: No moving parts micro-valves [14].

All three micro-valves were optimized for SLM production. This included ensuring a minimum internal cavity dimension of 0.5mm to remove unfused powder

and changing the build direction to minimize the number of down-facing surfaces. The latter is important to minimize the surface roughness. The final prototype production was done by LayerWise [9] in Belgium. Figure 7 shows an X-ray image of each of the prototype NMP micro-valves. In the case of the T4530 two NMP micro-valves are placed in series. The light-grey arrow in each image is produced on the outside of the part and indicates the forward flow direction.

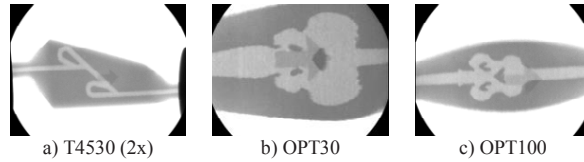

Figure 7: X-ray images of prototype NMP micro-valves.

The prototype NMP micro-valves were tested experimentally by measuring the pressure head for forward and backward flows at identical flow rates. The NMP micro-valve performance is indicated by the diodicity (D_i), defined as:

$$D_i = \frac{\Delta P_{backward}}{\Delta P_{forward}} \quad (1)$$

Ideally the forward pressure head should be low and the backward pressure head high, i.e. a high diodicity. According to Bardell [15], typical diodicity values for micro-scale NMP valves are relatively low, in the range of $1 < D_i < 2$.

For low Reynolds numbers (0 to 200), all micro-valves performed with diodicity values between 1.0 and 1.5. For certain flow rates the diodicity even dropped below 1.0, indicating an easier backward flow compared to the forward flow. For higher Reynolds numbers (200 to 600) only the OPT100 valve showed increased performance with a diodicity approaching 2.0.

The fact that the micro-valves are not performing optimally for the designed Reynolds number has most likely to do with the manufacturing process. Additive manufacturing is known to generate a relative high surface roughness. This is also visible in Figure 7(b), where the circular shape of the OPT30 has a wavy pattern on the right hand side. The wavy pattern is expected to disturb the intended laminar flow at a Reynolds number of 30.

4.2. Passive check micro-valve

Passive check valves are commonly made of polymeric material because of its high flexibility and low wear. Since the SLM process cannot fuse titanium and a polymer in a single part, the passive check valves

are designed from titanium as well. The individual layer thickness of the SLM process is about $50\mu\text{m}$ and the minimum feature thickness is 0.3mm [9]. Hence, the minimum number of stacked layers is six.

Two types of check micro-valves were tested: (1) the springboard type and (2) the cross type, as shown in Figure 8. The former is a miniature version of a swimming pool springboard, whereas the latter contains three beams acting as springs connected to a center section. Both check micro-valves are able to deflect when a (fluid) force is applied. The advantage of the cross type is that the micro-valve deflects without tilting the center section. The amount of deflection is determined by the micro-valve's geometry.

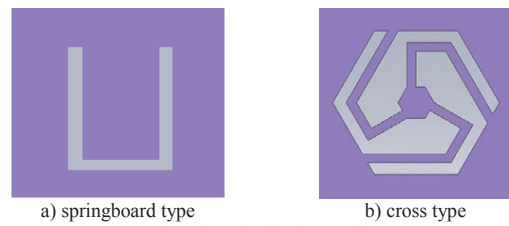







Figure 8: Two types of passive check micro-valves.

Two springboard and four cross types were produced according to Table 1. The right most column indicates the calculated deflection for a micro-valve of 0.3mm thickness under a load on 0.1N at either the tip (springboard) or the center (cross type). The experimental validation however showed that for this thickness none of the micro-valves was operating adequately. Most likely the stiffness of the valves was too high, causing an insignificant deflection. Hence a redesign for 0.2mm thickness was made, dropping below the minimum SLM process feature size. The calculated deflections for these micro-valves are shown in the fourth column.

Table 1: Micro-valve dimensions and calculated deflections.

Valve type	Beam width (mm)	Beam length (mm)	Deflection (mm) at 0.1N (t=0.2mm)	Deflection (mm) at 0.1N (t=0.3mm)	
	1	0.7	2.0	0.005	0.001
	2	1	3.0	0.01	0.003
	3	0.15	4.0	0.51	0.15
	4	0.2	3.6	0.29	0.085
	5	0.25	2.5	0.07	0.022
	6	0.35	3.7	0.17	0.052

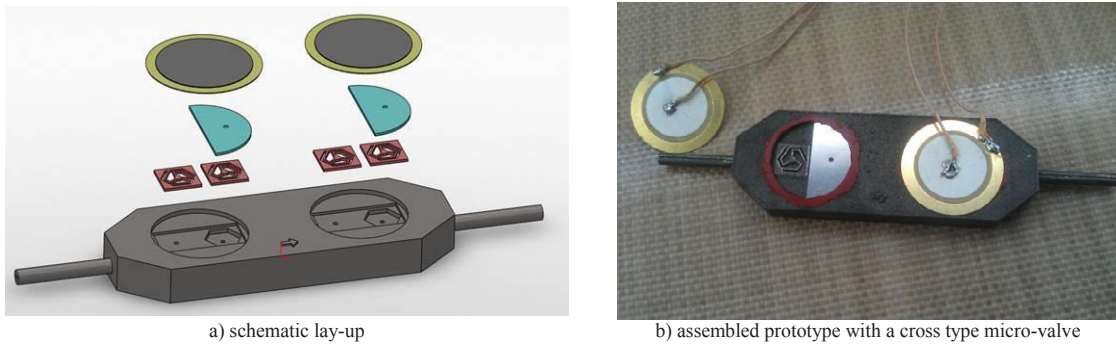

Figure 9: Micro-valves and piezo disks placement in the micro-pump assembly.

The check micro-valve performances were measured using a generic micro-pump assembly housing two micro-pumps in series similar to the Bartels mp6 that was presented in Section 2.1. This assembly was also produced using SLM. The micro-valves were put into the assembly, placing the piezo actuator disks on top as shown in Figure 9(a). The left micro-valve can only move upwards. The downward movement of the right micro-valve is made possible by the hexagon cutout. To block the upward movement here an additional half circular disk (blue) is inserted into the stack. To close the micro-pump the piezo disks are bonded onto the assembly. The final assembled prototype is shown in Figure 9(b); the bottom part only weighs about 150g .

Using the assembled prototype the volumetric flow rate was measured as a function of the piezoelectric disk's frequency for all 6 micro-valve types. As the working fluid Galden HT-90 [16] was used due to (future) space requirements, compatibility issues and its capability to function at high pressures. The measurements were done repeatedly on several days, showing consistent results. As mentioned the micro-valves of 0.3mm thickness did not show satisfactory pumping capacity. The maximum result in this case was a flow rate of about 0.1ml/min. for micro-valve no.6. The flow rate results for the 0.2mm thickness micro-valves are much better as shown in Figure 10.

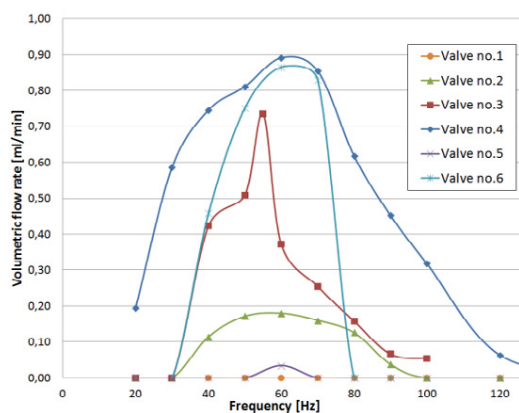

Figure 10: Flow rate results of micro-valve types of 0.2mm thickness.

Micro-valves no.4 and 6 (i.e. the top two lines, respectively) show the best performance. At about 60-70Hz the micro-pump is able to pump almost 0.9ml/min. Also, micro-valve no.3 (red) shows some effective pumping power at a lower frequency however. The others (i.e. micro-valves no.1, 2 and 5) show no significant pumping performance.

In general, the springboard type micro-valves show poor performance. This is most likely due to the fact that they tilt during deflection, which in turn causes the micro-valve not to close properly. For the cross type this is not the case. Here, for best performance the calculated deflection should be in the range of 0.2–0.3mm according to Table 1.

The surface roughness of the SLM parts should also be considered. As mentioned, in general the parts tend to have a relative high surface roughness compared to conventional manufacturing techniques. This is also confirmed by microscopic imaging of the micro-valves as shown in Figure 11. Here, the red line indicates the designed contour; however, quite some powder has been melted to the micro-valve outside this region.



Figure 11: Microscopic image of a cross type micro-valve.

Since the check micro-valve is exposed to cyclic loading, fatigue is also an important limitation. The reported stress limit for Titanium alloy Grade 5 is about 600MPa for 10^7 cycles [17-19]. This value is however for bulk material. As the SLM produced parts are not made from bulk material and the number of layers is below the recommended number, it is very likely that the reported 10^7 cycles is not a realistic number.

5. Final micro-pump design

The final micro-pump design consists of two main parts: a basis and a lid. This is illustrated in Figure 12. The basis includes the internal fluid lines and cutouts for the micro-valve and piezo disk placement, similar to the layout of Figure 9. The lid is required to hermetically seal the micro-pump, but also to pressurize the topside of the piezo disks. Without this counter pressure, the disks cannot withstand working pressures up to 60bar.

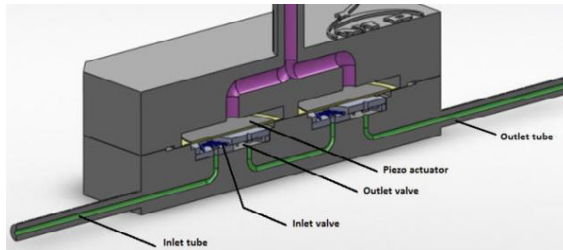

Figure 12: Final micro-pump design (cross sectional view).

After assembly, the basis and the lid are sealed using a laser welding technique around the micro-pump's complete boundary line. This sealing process has been tested experimentally by welding two circular pieces of Titanium metal together having a similar cavity inside. Leak tests using a helium mass spectrometer (i.e. a Oerlikon Leybold UL200) proved that a seal with a leak rate smaller than 10^{-10} mbar·l/s is possible. This value equals the upper detection limit of the mass spectrometer and indicates a (virtually) 100% leak tight seal. The seals were retested after pressurizing the cavity up to 60bar and remained leak tight.

During the welding process also the internal temperature was monitored at several locations. At 2mm distance inward from the boundary line, a maximum temperature of 52°C was measured. This temperature is well below the maximum temperature the piezo disks and bond material can withstand.

6. Conclusions

This study focused on the development of a micro-pump to operate a two-phase cooling loop for small satellite applications. Using Selective Laser Melting (SLM) as a metal additive manufacturing technique several proof-of-concept micro-pumps were developed from Titanium alloy Grade 5 (i.e. Ti6Al4V). Both no moving parts valves and passive check valves were investigated as micro-pump valve design. The developed prototypes weigh about 300g and show promising pump capacities, especially using cross type check micro-valves. Galden HT-90 was used as the working fluid. The micro-pumps are considered as high potential for future space applications and other harsh environments.

Future research is targeted to better understand the cyclic loading behavior of thin SLM produced parts. Fatigue testing should be done to characterize acceptable stress limits for the check micro-valves. Also, the lid can be redesigned similar to the basis. In this case, the upward suction stroke can be a discharge stroke for the upper section at the same time. Effectively getting two micro-pumps using a single piezo disk.

Acknowledgements

The authors would like to acknowledge the technical support of Aswin Pauw, Gerrit van Donk and Roel Sieders (NLR). For the SLM parts' design in general, we thank Marc de Smit (NLR) for his expertise. For the laser welding of the final micro-pump assembly, we value the expert input of Arjen de Boer and Folkert Vrijburg (Philips). Also, LayerWise is acknowledged for their quick response in both design feedback and the production of the SLM parts.

References

- [1] Wikipedia Satellite, 2012. <http://en.wikipedia.org/wiki/Satellite>, last accessed December 2012.
- [2] Van Benthem, R. and Van Es, J., 2009. PEP Micro-pumped Micro Heat Spreader cooling - WP2000 system trade-off and preliminary system design, Internal Report National Aerospace Laboratory NLR, Marknesse, The Netherlands.
- [3] Van Es, J., 2011. Space Thermal Control, Internal Presentation National Aerospace Laboratory NLR, Marknesse, The Netherlands.
- [4] Thomas, L.J. and Bessman, S.P., 1975. Micropump powered by piezoelectric disk benders, US patent no. 3963380.
- [5] Laser D. and Santiago, J., 2004. A review of micropumps, in *"Journal of micromechanics and microengineering"*, pp. R35-R64.
- [6] Bartels Mikrotechnik company website, 2012. <http://www.bartels-mikrotechnik.de>, last accessed December 2012.
- [7] Bourell, D.L., Leu, M.C., Chakravarthy, K., Guo, N. and Alayavalli, K., 2011. Graphite-based indirect laser sintered fuel cell bipolar plates containing carbon fiber additions, in *"CIRP Annals - Manufacturing Technology"*, Elsevier Ltd., Vol. 60-1, pp. 275-278.
- [8] Frick, W., 2011. Will additive manufacturing put milling machines out of work?, *American Machinist*, April 27.
- [9] Layerwise, 2012. Personal contact and company website, <http://www.layerwise.com>, Leuven, Belgium.
- [10] Renishaw, 2012. Company website, <http://www.renishaw.nl>, Breda.
- [11] SLM Solutions GmbH, 2012. Company website, <http://www.slm-solutions.com>, Lübeck, Germany.
- [12] EOS e-manufacturing solutions, 2012. Company website, <http://www.eos.info>, München, Germany.
- [13] Kwang, W.O. and Chong, H.A., 2006. A review of microvalves, in *"Journal of micromechanics and microengineering"*, pp. R13-R39.
- [14] Lin, S., Deng, Y., Wu, Y., Liu, Z., 2012. Optimizing Tesla valve for inertial microfluidics, the third international conference of advances in microfluidics and nanofluidics, Dalian, China.
- [15] Bardell, R.L., 2000. The Diodicity Mechanism of Tesla-Type No-Moving-Parts Valves, PhD thesis, University of Washington.
- [16] Provac Sales, Inc., 2012. Datasheet Galden HT-90, <http://www.provac.com>, Santa Cruz, CA USA.
- [17] Arcam EBm system, 2012. Datasheet Ti6Al4V Titanium Alloy, <http://www.arcam.com>, Mölndal, Sweden.
- [18] Niinomi, M., 2007. Fatigue Characteristics of Metallic Biomaterials, in *"Int. Journal of Fatigue"*, Vol. 29, pp. 992-1000.
- [19] Aerospace Specification Metals Inc, 2012. Titanium Ti-6Al-4V (Grade 5), ELI, Annealed, <http://asm.matweb.com>, Pompano Beach, Florida USA.