

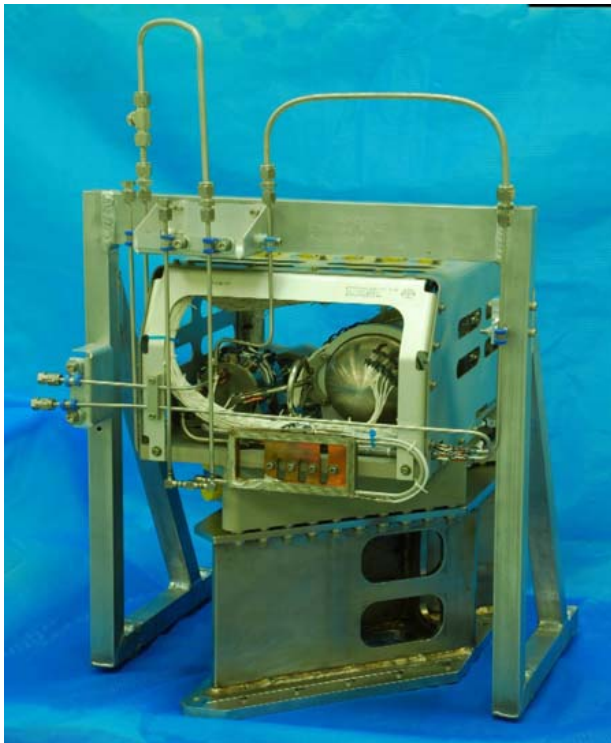

## Executive summary

# AMS02 Tracker Thermal Control System overview and spin-off for future spacecraft cooling system developments



Tracker Thermal Control System Component Box

### Report no.

NLR-TP-2009-699

### Author(s)

J. van Es  
A. Pauw  
G. van Donk  
T. Zwartbol  
co-authors

### Report classification

UNCLASSIFIED

### Date

December 2009

### Knowledge area(s)

Ruimtevaartinfrastructuur en -  
payloads

### Descriptor(s)

Satellite Thermal Control  
Space  
Two Phase Cooling Systems  
International Space Station

## Summary

The AMS Tracker Thermal Control System (TTCS) is a two-phase cooling system developed by NLR (The Netherlands), INFN Perugia (Italy), Sun Yat Sen University, Zhuhai (China), AIDC Taichung, Taiwan, Massachusetts Institute of Technology (USA), and NIKHEF (The Netherlands). The TTCS is

part of the Alpha Magnetic Spectrometer (AMS02) experiment to be located on the International Space Station (ISS) truss. The TTCS is a mechanically pumped two-phase carbon dioxide cooling loop. Main objective is to provide accurate ( $< 3$  K) temperature control and remove 140 W heat of the AMS02 Tracker front-end electronics. The TTCS

This report is based on a paper presented at the 60th International Astronautical Congress, Daejeon, Korea, 12-16 October 2009.

requirements, system design, development status and some typical test results are described. Final integration of the TTCS is scheduled October 2009. An outlook is given to potential spin-off. In particular to what extent the system can be used as cooling system for high-power communication satellites, future

scientific spacecraft requiring tight temperature control and AMS-like terrestrial particle detectors used at CERN.



NLR-TP-2009-699

## AMS02 Tracker Thermal Control System overview and spin-off for future spacecraft cooling system developments

J. van Es, A. Pauw, G. van Donk, T. Zwartbol and co-authors

This report is based on a paper presented at the 60th International Astronautical Congress, Daejeon, Korea, 12-16 October 2009.

The contents of this report may be cited on condition that full credit is given to NLR and the authors.

This publication has been refereed by the Advisory Committee AEROSPACE SYSTEMS & APPLICATIONS.

Customer	National Aerospace Laboratory NLR
Contract number	----
Owner	National Aerospace Laboratory NLR
Division NLR	Aerospace Systems and Applications
Distribution	Unlimited
Classification of title	Unclassified
	June 2010

Approved by:

Author J. van Es 24/06/2010 	Reviewer  6/7/2010	Managing department  4/7/2010
---------------------------------------	--------------------------	-------------------------------------

## **Contents**

### **ABSTRACT**

### **INTRODUCTION**

**3**

Alpha Magnetic Spectrometer (AMS)

3

AMS02 Tracker

3

### **TTCS INTRODUCTION**

**4**

TTCS design challenges and requirements

4

TTCS Design considerations

5

TTCS Concept

5

TTCS Mollier diagram

7

### **TTCS DESIGN AND DEVELOPMENT**

**7**

Development team

7

TTCS Hardware locations

8

Tracker Thermal Control Boxes

8

### **TTCS TEST RESULTS**

**11**

### **SPIN-OFF AND FUTURE DEVELOPMENTS**

**12**

### **CONCLUSIONS**

**12**

### **REFERENCES**

**12**

### **ACRONYMS**

**13**

### **ACKNOWLEDGEMENT**

**13**

## IAC-09.C2.7.1

### AMS02 TRACKER THERMAL CONTROL SYSTEM OVERVIEW AND SPIN-OFF FOR FUTURE SPACECRAFT COOLING SYSTEM DEVELOPMENTS

#### Author:

Johannes van Es, National Aerospace Laboratory (NLR); The Netherlands [jvanes@nlr.nl](mailto:jvanes@nlr.nl)

#### Co-authors:

- A. Pauw, National Aerospace Laboratory (NLR), The Netherlands [pauw@nlr.nl](mailto:pauw@nlr.nl)  
 G. van Donk, National Aerospace Laboratory (NLR), The Netherlands [gvdonk@nlr.nl](mailto:gvdonk@nlr.nl)  
 T. Zwartbol, National Aerospace Laboratory (NLR), The Netherlands [zwartbol@nlr.nl](mailto:zwartbol@nlr.nl)  
 Zh. He Sun, Yat-Sen University (SYSU), China, [stshzh@mail.sysu.edu.cn](mailto:stshzh@mail.sysu.edu.cn)  
 B. Verlaat, National Institute for Subatomic Physics (NIKHEF), The Netherlands, [bverlaat@nikhef.nl](mailto:bverlaat@nikhef.nl)  
 C. Gargiulo, Istituto Nazionale Fisica Nucleare (INFN), Italy, [corrado.gargiulo@roma1.infn.it](mailto:corrado.gargiulo@roma1.infn.it)  
 E. Laudi, Istituto Nazionale Fisica Nucleare (INFN), Italy, [elisa.laudi@gmail.com](mailto:elisa.laudi@gmail.com)  
 A. Alvino, Istituto Nazionale Fisica Nucleare (INFN), Italy, [antonio.alvino@hotmail.com](mailto:antonio.alvino@hotmail.com)  
 D.J. Sun, Aerospace Industrial Development Corporation (AIDC), Taiwan, [drjsun@ms.aidc.com.tw](mailto:drjsun@ms.aidc.com.tw)  
 J.M. Shue, Aerospace Industrial Development Corporation (AIDC), Taiwan, [gimoshue@ms.aidc.com.tw](mailto:gimoshue@ms.aidc.com.tw)  
 C.C. Yeh, Aerospace Industrial Development Corporation (AIDC), Taiwan, [chunchingyeh@msl.aidc.com.tw](mailto:chunchingyeh@msl.aidc.com.tw)  
 V. Koutsenko, Massachusetts Institute of Technology (MIT), USA, [vladimir.koutsenko@cern.ch](mailto:vladimir.koutsenko@cern.ch)  
 A. Lebedev, Massachusetts Institute of Technology (MIT), USA, [alexei.Lebedev@cern.ch](mailto:alexei.Lebedev@cern.ch)  
 P. Dieleman, National Aerospace Laboratory (NLR); The Netherlands [dieleman@nlr.nl](mailto:dieleman@nlr.nl)

#### ABSTRACT

The AMS Tracker Thermal Control System (TTCS) is a two-phase cooling system developed by NLR (The Netherlands), INFN Perugia (Italy), Sun Yat Sen University, Zhuhai (China), AIDC Taichung, Taiwan, Massachusetts Institute of Technology (USA), and NIKHEF (The Netherlands). The TTCS is part of the Alpha Magnetic Spectrometer (AMS02) experiment to be located on the International Space Station (ISS) truss. The TTCS is a mechanically pumped two-phase carbon dioxide cooling loop. Main objective is to provide accurate ( $< 3$  K) temperature control and remove 140 W heat of the AMS02 Tracker front-end electronics. The TTCS requirements, system design, development status and some typical test results are described. Final integration of the TTCS is scheduled October 2009. An outlook is given to potential spin-off. In particular to what extent the system can be used as cooling system for high-power communication satellites, future scientific spacecraft requiring tight temperature control and AMS-like terrestrial particle detectors used at CERN.

#### INTRODUCTION

##### Alpha Magnetic Spectrometer (AMS)

The Alpha Magnetic Spectrometer (AMS) is a space born detector for cosmic rays built by an international collaboration, lead by Nobel prize laureate S.C. Ting and will operate aboard the truss of the International Space Station (ISS) for at least 3 years, collecting several billions of high-energy protons and nuclei [1].

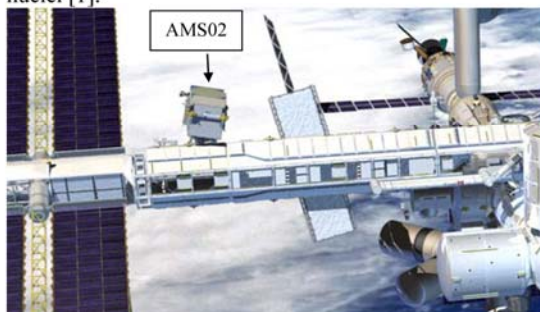

Figure 1: AMS02 Location on ISS (picture by NASA)

The main goal is to search for cosmic antimatter, (that is for anti-helium nuclei primarily), for dark matter and lost matter. A first version of the detector, known as AMS-01, flew aboard the shuttle Discovery during the STS-91 mission (2-12 June 1998), collecting information about hundred millions of cosmic rays [1]. This trial mission confirmed the main ideas of the project and gave important suggestions for further development.

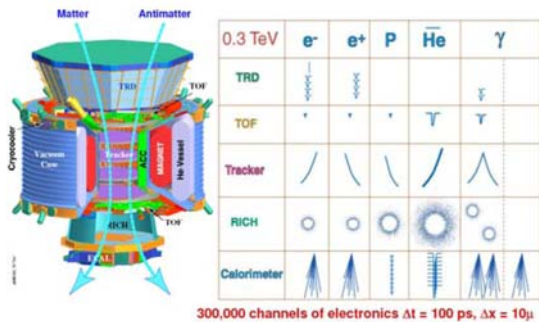

Figure 2: Cutaway view of the AMS02 detector (left). Response of the detectors layers to a charged particle of energy 0.3 TeV (Picture by R. Becker MIT, Data courtesy of MIT)

For the ISS mission, the detector will be slightly different in concept, achieving a higher resolution. In fact, AMS-02 will be an "improved" version of AMS-01. The solid magnet of the AMS-01 mission will be replaced by a more powerful Helium cooled super-conductive cryo-magnet in AMS-02. Most important improvement in AMS02 is the capability to detect anti-Helium. Detection of a single clean anti-Helium nucleus would be really exciting. Apart from the detection of anti-Helium AMS02 has lots of other capabilities to study the sources of cosmic rays [1]. The expected responses of matter and anti-matter particles in the various AMS detectors is shown in Figure 2.

AMS02 Tracker

The heart of the AMS02 experiment is the Silicon Tracker. It measures particle trajectories through AMS's strong magnetic field. In a magnetic field, charged particles do not move in straight lines, but rather in arcs. The higher the particle's momentum, the smaller the deflection. The direction of curvature is also important - a particle with positive charge will bend to the right, a particle with negative charge will bend to the left. The tracker is the most important detector in the anti-helium search as it is the only detector that can discriminate between helium and anti-helium.

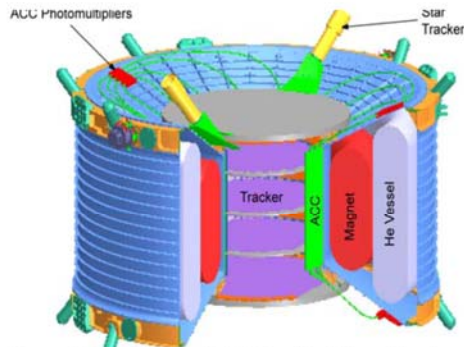

Figure 3: The heart of AMS02 with Silicon Tracker (picture by R. Becker MIT)

The tracker consists of eight large, thin sheets of silicon. The silicon sheets have millions of tiny aluminium stripes on them; each stripe generates an electrical signal when struck by a particle. Since the stripes are so small, it is known where the particle hit with an accuracy of ten microns. By looking at the hits on all eight planes, it is possible to follow the track of the particle by combining the hits on the several planes. This silicon technology is similar to the technology used for other large particle-physics experiments.

Around the 8 silicon planes detecting front-end electronics are located. These dedicated electronics provide the accurate measurements needed. However the electronics need to be very stable in temperature (< 3 K) while dissipating 144 Watt of heat.

In order to keep the Tracker stable in temperature the Tracker waste heat need to be collected and radiated to deep space. In AMS-01 the massive solid magnet was used to collect the heat produced by the Tracker electronics. The strict temperature stability requirements could be easily met by introducing good thermal connections from the electronics to this plenum of heat capacity (the solid magnet). The temperature of the magnet slowly increased and could be lowered again by increasing the view factor to space.

In AMS02 the situation is different by the introduction of the cryo-cooled magnet. The introduction of the cryo-magnet did not only introduce additional magnet cooling it also increased the thermal design complexity of the Tracker Thermal Control System (TTCS). In AMS-02 the super-conductive magnet does not provide a large heat capacity to keep the electronics uniform in temperature. Therefore a new thermal design was required to meet the stringent electronics temperature stability requirements.

TTCS INTRODUCTION

TTCS design challenges and requirements

Main design challenge in the TTCS design is to transport the heat from the centre of the experiment to two dedicated radiators at the outside. Complicating factor is that limited to no metal equipment is allowed inside the magnet and the available volume is extremely limited.

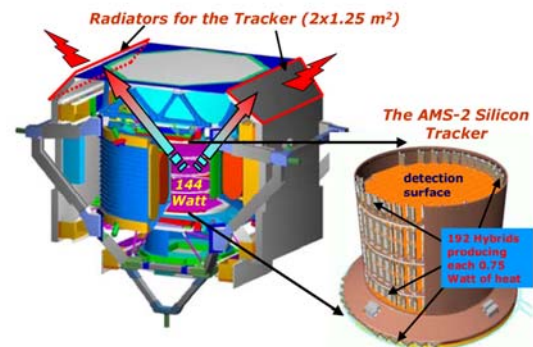

Figure 4: Schematic of the Tracker cooling challenge



On top of that, the heat producing elements, the tracker front-end electronics, are widely distributed at the periphery of the tracker silicon planes. At no less than 192 locations a total of 144 Watt is dissipated. The temperature requirements for these front-end electronics are:

**Silicon wafer thermal requirements:**

- **Operating temperature:**  
-10 °C / +25 °C
- **Survival temperature:**  
-20 °C / +40 °C
- **Temperature stability:**  
3 °C per orbit
- **Maximum accepted gradient between any silicon:**  
10.0 °C
- **Dissipated heat:**  
2.0 Watt EOL

**Hybrid circuit thermal requirements:**

- **Operating temperature:**  
-10 °C / +40 °C
- **Survival temperature:**  
-20 °C / +60 °C
- **Dissipated heat:**  
144 W total ( $\pm 10\%$ ),  
0.75 W per hybrid pair  
( $S=0.47$  W,  $K=0.28$  W)

The temperature requirements for the Tracker radiators are:

Operating temperature: -40 °C/+25 °C  
 Non-operating: -120 °C/+65 °C

Because of the vital importance of the Tracker detector it was decided to implement also a redundant thermal control system.

TTCS Design considerations

At first sight a combined Loop Heat Pipe (LHP) and Heat Pipe (HP) design seems the most straightforward solution for a space application like AMS02. However this would mean implementing a complex HP structure inside the magnet to collect the heat at the 192 locations. A second connecting layer of heat pipes would be needed to transport the heat outside the magnet and Tracker where the heat would be collected by LHP's transporting the heat to the Tracker radiators. This design was rejected as the amount of metal mass and hardware inside the magnet would be detrimental to the AMS02 experiment.

A second natural solution is implementing a single phase cooling loop and collecting the heat at the 192 dissipating elements by the heat capacity of the working fluid. Ammonia would be the most promising candidate working fluid for such a system. However it was found that even with the maximum permitted tube diameter the temperature drop over the needed tube length was far above the required maximum of 10 °C between two Tracker silicones.

As straightforward solutions were not feasible a more dedicated system was needed. It was decided to verify if boiling a working fluid inside a tube could deal with the temperature stability and limited volume requirements. Based on pressure drop calculations however this showed to be also not straightforward [2]. For instance the boiling of ammonia in a small diameter tube (3mm) along the Tracker induces such high pressure drops that the corresponding temperature drop along the 9 m long tube would exceed by far the temperature stability requirement. The problem is the large vapour pressure drop as the ammonia vapour density is 1000x smaller than the liquid density. Only a working fluid with a small ratio between vapour and liquid density could fulfil the requirements. The

only possible candidate is CO<sub>2</sub> with a ratio of 1:10. The concept was first tested at NIKHEF [2], and further optimised and tested in a full scale breadboard at NLR [3].

TTCS Concept

The TTCS is a mechanically pumped two-phase carbon dioxide cooling loop. In figure 5 the layout of the TTCS-loop is shown and in table 1 the functionality of the main components is summarised. By following the loop routing in the loop operation is explained. At the pre-heaters the working fluid temperature is lifted to the saturation temperature. The working fluid enters the evaporator with a quality slightly above zero, ensuring a uniform temperature along the complete evaporator.

Due to the widely distributed front-end electronics the evaporator consists of two parallel branches collecting the heat at the bottom and top side of the Tracker planes.

Component	Function
Pump	Transport the fluid through the loop
Accumulator	Regulate the evaporator temperature in the tracker Account for the expansion of the working fluid
Accumulator Peltier elements	Regulate evaporation set-point in all operation modes (cooling)
Accumulator heaters	Regulate evaporation set-point in all operation modes (heating) Emergency accumulator heat-up in case liquid line temperature approaches saturation temperature (to avoid cavitation in pump)
Heat Exchanger	Exchange heat between hot evaporator outlet and cold evaporator inlet. Reduction of pre-heater power.
Evaporator	Collect heat at the tracker electronics. The evaporation process provides the temperature stability required.
Condensers	Remove the heat from the working fluid to the radiators. The condensing process makes the heat transfer effective.
Absolute Pressure Sensors (APS)	Monitor the absolute pressure inside the loop
Differential Pressure Sensor (DPS)	Monitor pump pressure head
Pre-heaters	Heat evaporator liquid inlet to saturation point
Liquid line heaters	Heaters to defrost the condenser inlet and outlet lines after an AMS02 power down
Dallas Temperature Sensors	Monitoring TTCS temperatures (by the TTCE) Monitoring TTCS as part of the AMS overall GTSN Dallas sensor network
Pt1000 Temperature Sensors	Control accumulator temperature Control pre-heater on/off Monitor cold temperatures on radiator and liquid lines

Table 1: TTCS Components functionality

With an overall mass flow of 2 g/s the mean quality at the outlet of the evaporators is approximately 30%. The two-phase flow of both branches is mixed and led through the heat exchanger where heat is exchanged with the incoming sub-cooled liquid. Behind the heat exchanger the two-phase line (red) is split. One branch leads to the condenser at the RAM heat pipe radiator and the other is lead to the condenser at the Wake heat pipe radiator, where the heat is rejected to space.

The sub-cooled liquid of both liquid lines is mixed. In principal this flow distribution is self-adjusting [3]. The flow to the branch with the highest quality will induce the largest pressure drop. Hence a larger part of the condenser flow will be directed to the opposite condenser branch. At the end of the condensers the fluid is sub-cooled well below the saturation point so arrives in liquid phase back at the pump.

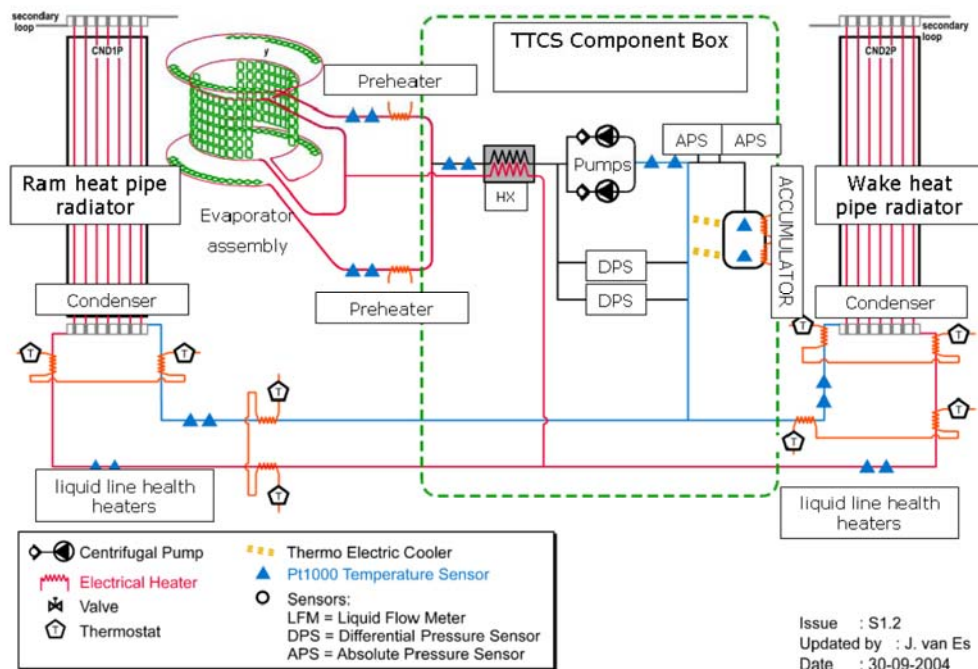

Figure 5a: Tracker Thermal Control System Loop Schematic



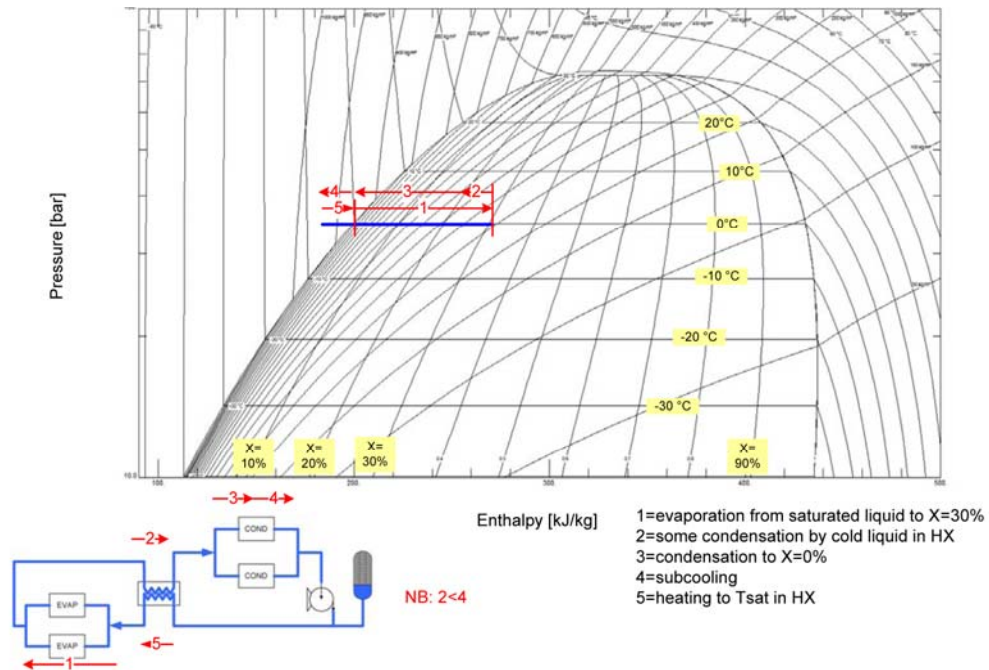

Figure 5b: TTCS operation in a pressure-enthalpy diagram (picture by G. van Donk, NLR)

Downstream the pump the sub cooled liquid is pre-heated by exchanging heat with the returned two-phase flow from the evaporator. In most cases the heat exchanger lifts the sub cooled liquid to saturation. Only in extreme cold orbits additional 8 W pre-heater power per branch is needed to create saturation.

The thermal control room of the TTCS is the accumulator. It is the largest two-phase volume in the loop and it therefore dictates the saturation (and thus evaporation) temperature in the loop. The big advantage is that the accumulator can be situated far away from the electronics in the confined Tracker area. This gives system designers the possibility to make an elegant detector design and locate the control at a location where volume is available and control actuators do not affect the stability of the sensors. The accumulator is controlled by heaters and thermo-electric cooling. Test results showed that a stability <1K can easily be met [3].

TTCS Mollier diagram

In figure 5b the TTCS “cooling” concept is shown in the CO<sub>2</sub> Mollier diagram. As TTCS operates at almost uniform pressure TTCS operation is represented by a horizontal line in the diagram. In the evaporator the enthalpy increases (1) until the 30% quality line indicating that 30% of the liquid is evaporated. At the end of the evaporator the working fluid reaches the highest enthalpy point of the loop. After the evaporator the enthalpy is lowered first in a heat exchanger (2) by heat transfer to the sub-cooled liquid and then in the condensers by heat transfer to deep space (3). When all vapour is condensed the TTCS enters the liquid area of the diagram (4). When leaving the condenser the liquid is at the coldest (and also minimum enthalpy) point of the operation. The

liquid flows back to the heat exchanger (5) where the temperature and enthalpy is increased (close) to saturation again.

In the next sections details of the TTCS design and loop components are shown and elucidated.

**TTCS DESIGN AND DEVELOPMENT**

Development team

The TTCS is developed by an international team consisting of NLR (The Netherlands) INFN Perugia (Italy), Sun Yat Sen University, Zhuhai (China), AIDC Taichung, Taiwan, Massachusetts Institute of Technology (USA), and NIKHEF (The Netherlands). NLR is the overall technical, system design and safety responsible, co-ordinating the widespread project team. NLR is also main responsible for the condenser and heat exchanger design and development [5]. However the major contributions from INFN, SYSU, AIDC, MIT and NIKHEF were also vital to the success of the project. NIKHEF [2] stood at the origin of the TTCS development by selecting CO<sub>2</sub> as candidate fluid [2] and designing the evaporator tube routing inside the Tracker. INFN as one of AMS major contributors and Tracker responsible delivered the mechanical box concept design, and supported the tubing and electronics design. Further major effort was done on co-ordinating condenser and HX manufacturing and by providing the test facilities for component box testing. SYSU, a Chinese University, supported the TTCS development with Sinda-Fluint modelling and it built and operated the TTCS Engineering Model Loop [6,7,8] in Zhuhai China. Additional to that it supported TTCS in the procurement of loop components (Pumps, APS, DPS

accumulator, and filling system). SYSU co-ordinated the accumulator development which was performed at the Chinese Academy of Space Technology (CAST) under technical supervision and support of NLR and NASA. A major effort was also done by AIDC (Taiwan) in manufacturing and integration of the TTCS heat exchangers, condensers and components boxes. MIT finally took responsibility of Tracker Thermal Control Electronics (TTCE) development. Due to all these contributions the TTCS component boxes are now qualified and ready for integration on the AMS02 experiment.

TTCS Hardware locations

In figure 6 the location of the TTCS H/W on AMS02 is shown. Two complete redundant systems are integrated. The Primary loop is located on the Port side and the Secondary loop is located on the Starboard side.

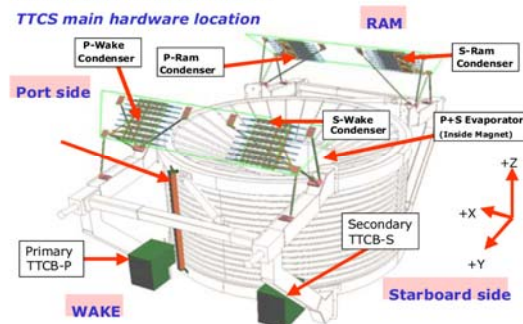

Figure 6: AMS overview with TTCS H/W

Each system consists of five main components:

- Evaporators (2 per loop, one at the bottom and one at the top)
- Tracker Thermal Control Box (TTCB) (1 per loop)
- Condensers (2 per loop)
- Transport tubes to connect the components
- Tracker Thermal Control Electronics (TTCE)

Tracker Thermal Control Boxes

The heart of the TTCS loops are the Tracker Thermal Control Boxes (TTCB). In these TTCB's all components to operate the TTCS loops are combined. Both TTCB's are connected to the AMS Unique Support Structure (USS) on the Wake side.

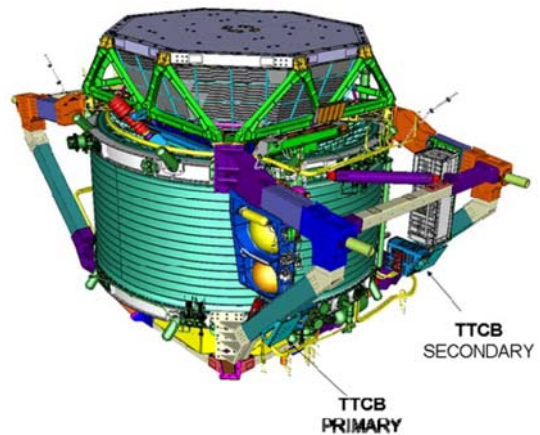

Figure 7: Location of the Thermal Tracker Control Boxes (Picture by C. Gargiulo)

The TTCB's are connected by transport tubes to the TTCS condensers and evaporators as shown in Figure 8. The inlets to the evaporator sections (top and bottom) are located on port side. Therefore TTCS Secondary has slightly larger connecting tubing.

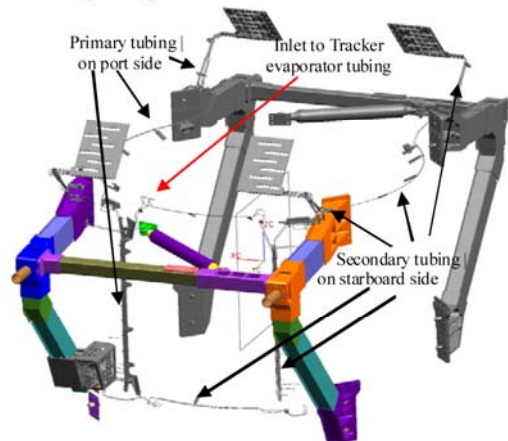

Figure 8: Overview of transport tubing and condensers (Picture by A. Alvino & E. Laudi INFN)

The TTCB's are designed to fit around the AMS USS. Most TTCB components are located on the TTCB base plate under an aluminium cover. The box cover and base plate sides are wrapped in Multi Layer Insulation (MLI) to insulate the components from the environment. Titanium (thermally insulating) washers are used to reduce also the heat leak to and from the USS.

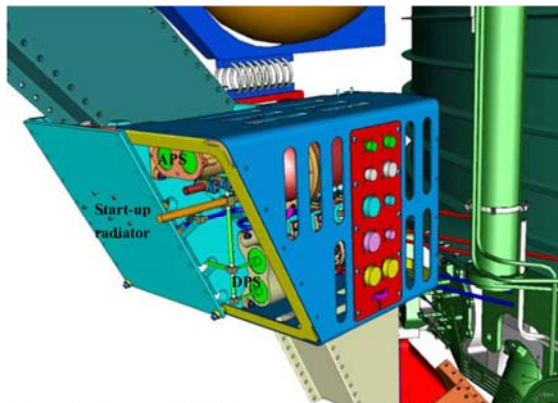

Figure 9: Primary TTCS box on port side of AMS (Picture by C. Gargiulo)

The TTCS pumps are the single components not located on the base plate. The pumps are located on the inside of a special start-up radiator. This start-up radiator radiates to the back side of the main wake radiator providing a lower temperature than the TTCS I/F with the USS.

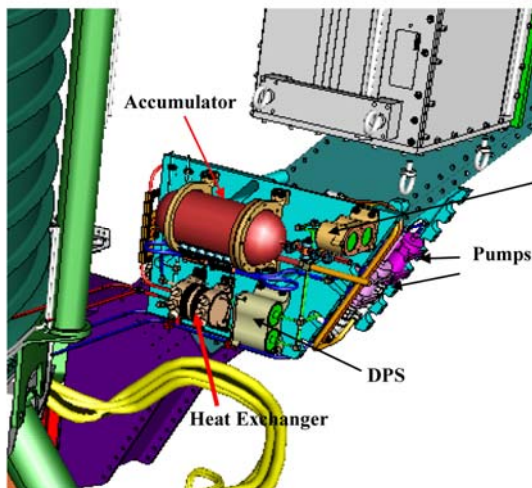

Figure 9: Secondary TTCS box on starboard side of AMS (Picture by C. Gargiulo INFN)

This is needed to increase the orbital time window for normal (liquid) TTCS start-up. The pump temperature should therefore be lower than the accumulator temperature and the CO<sub>2</sub> critical temperature (+33 °C). An open view of box assembly is shown in Figure 9.

A picture of the integrated box is shown in Figure 10.



Figure 10: TTCB-P box assembly on USS simulator and in vibration frame (picture by AIDC)

The box passed the qualification test program and is shipped to CERN for final AMS02 integration.

#### Evaporator

In figure 11 to figure 13 an overview of the evaporator lay-out is shown. The inner diameter of the evaporator is 2.6 mm and the total length is 9 m.

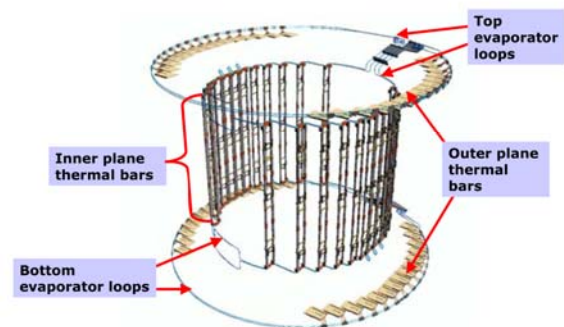

Figure 11: Evaporator lay-out with thermal bars (Picture NIKHEF)

Heat collected at the inner tracker planes is transported by thermal bars to the top and bottom evaporator ring. In Figure 13 the tube lay-out detail of the inner ring is presented, showing the complex distribution of the tracker front-end electronics.

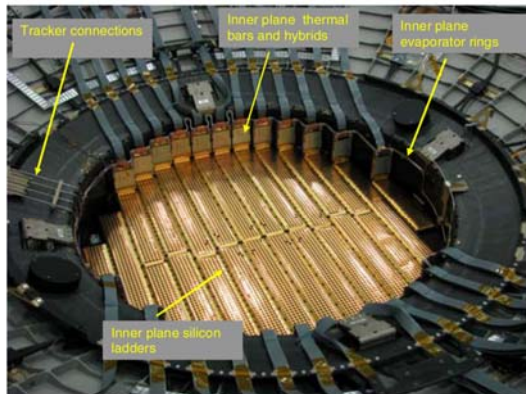

Figure 12: Top evaporator (Picture NIKHEF)

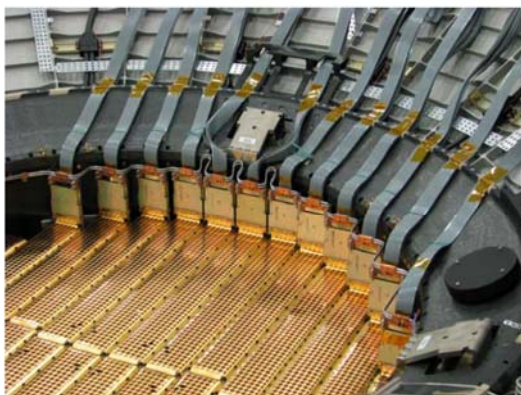

Figure 13: Inner evaporator ring detail (Picture NIKHEF)

### Condenser

The main function of the condensers is to dump the collected heat to the Tracker RAM and WAKE radiator. The vapour will condense at the set-point temperature. When all vapour is condensed, the liquid will be sub-cooled below the saturation point (set-point). For pump safe operation a minimum sub-cooling of 5 °C is required. Each loop has two parallel condensers, one on the WAKE Tracker radiator and one on the RAM Tracker radiator. The location of the condensers on the heat-pipe type radiators is shown in figure 14.

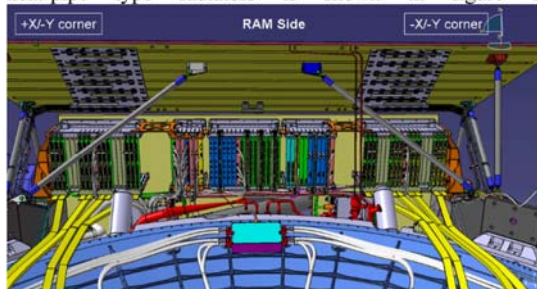

Figure 14: Condenser location on the heat pipe radiators (Picture by F. Cadoux, University of Geneva)

The condensers are attached to the heat pipes flanges. The heat pipes will distribute the heat further over the radiator in axial direction. Due to the fact that CO<sub>2</sub> can freeze and the radiator can become extreme cold (-120 °C) the condenser design is not straightforward. The main design drivers are:

- Freeze proof design in cold orbit in accordance with NASA safety requirements for pressurised systems
- Cover a temperature range of -120 °C to +65 °C (critical for connection between Inconel tubes and aluminium base plate)
- Heat transfer capability in hot orbit
- Small to moderate pressure drop through the condenser
- Fit on the Wake and RAM tracker radiators

In order to optimise the heat transfer capability to the radiator the design needs to look after sufficient heat transfer area and provide good thermal coupling between the condenser tubing and the radiator. The sufficient heat transfer area is realised by 7 parallel tubes which are meandering over the radiator to dump heat on each HP flange.

The major design challenge was to cope with the so-called freezing problem. In fact the freezing problem is a melting problem. In case of a full AMS power shutdown the temperature of the condenser section drops below the freezing temperature of CO<sub>2</sub> (-55 °C) down to -120 °C. In case the condenser heats up in an un-controlled manner, liquid CO<sub>2</sub> can be present in enclosures surrounded by solid parts. Rising temperatures can then induce high pressures. This is a potential safety risk. The design solution chosen for this problem is as follows.

- Allow freezing in part of the condenser tubing
- Make this condenser part freeze proof up to maximum environmental melting temperature (-5 °C) and corresponding pressure
- Show the rest of the TTCS tubing will never be below the CO<sub>2</sub> freezing point

In a special test programme NLR showed the maximum pressure during CO<sub>2</sub> thawing was 3000 bar at a -5 °C maximum environmental temperature [5]. It was also shown that a small diameter Inconel 718 tube ( $d_{in} = 1.0$  mm,  $d_{out} = 3.0$  mm) can withstand this pressure. Based on these results a detailed design was made, shown in figure 15.

Another design challenge was to connect the Inconel condenser tubes to the aluminium condenser base plate. This connection was made with MASTERBOND EP21TDC-2LO glue in order to cope with the CTE-difference between Inconel and aluminium. A last feature implemented in the condenser is the so-called liquid line health heater which is wrapped around the condenser inlet and outlet tubes. This heater is used to defrost the liquid inlet and outlet after an AMS02 power down. During an AMS02 power down the condensers will freeze and part of the inlet and outlets too. To avoid liquid is created in the condenser section while the inlet and outlet are still frozen, first the liquid health heater is switched on. This will melt the CO<sub>2</sub>. After this the Tracker radiator heaters can be switched on to defrost the CO<sub>2</sub> condenser itself.

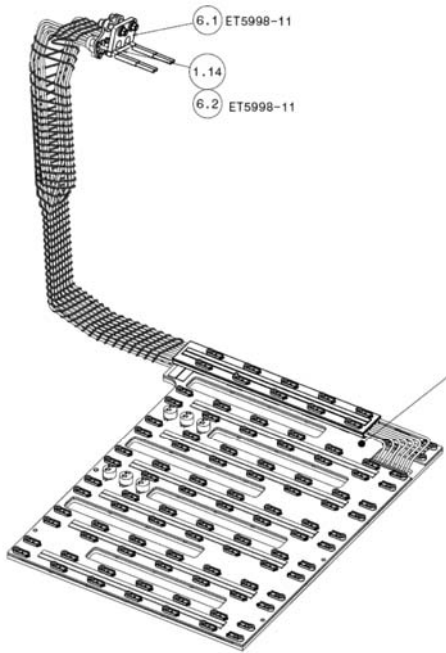

Isometric view

Figure 15: Condenser design (Picture by NLR)

**TTCS TEST RESULTS**

After the breadboard tests performed at NLR [3] a complete flight-like Engineering Model loop was built in Zhuhai China at the Sun Yat Sen University to perform system optimisation and system performance testing. In figure 16 and figure 17 a schematic and a picture of the TTCS Engineering model are shown.

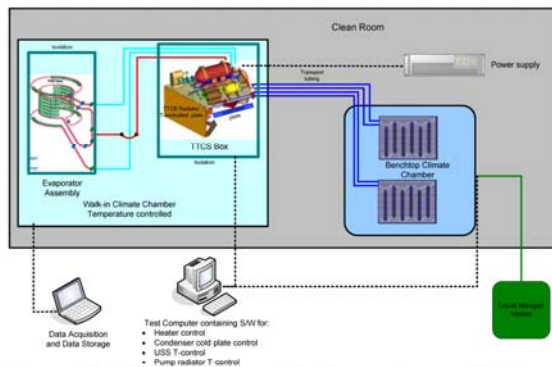

Figure 16: TTCS Engineering Model set-up (picture NLR)

The Engineering model has the following capabilities:

- Independent RAM and WAKE heat sink control
- Heat sink temperature range: -40 °C to +20 °C
- Set-point control: -20 °C to +25 °C
- Over 100 TC's, 108 heat input stations, delta-p and p-absolute measurements

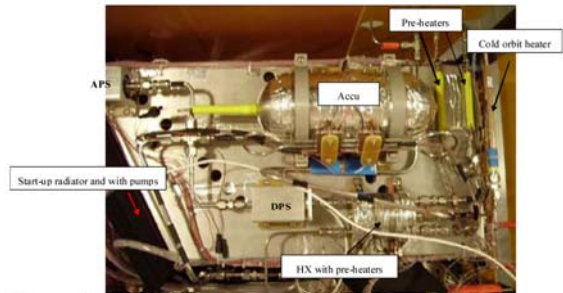

Figure 17: TTCS Engineering Model (Picture SYSU)

To minimise heat losses the breadboard is insulated where possible and located inside a climate chamber, kept at a temperature typically set just below set-point. The TTCS Engineering Model is first tested in a horizontal plane to simulate a  $\mu$ -g environment in both Primary and Secondary tube length. A second test campaign was performed in 3D layout to verify the TTCS can operate during AMS02 thermal vacuum testing in ESA's Large Space Simulator (LSS) in Noordwijk, the Netherlands.

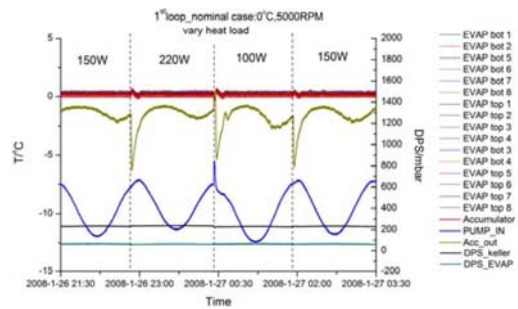

Figure 18: TTCS EM Evaporator heat load changes in nominal operating conditions (5000 rpm, SP=0 °C and simulated orbital environments)

It is shown that even with extreme changes in dissipation the evaporator temperatures stay stable (< 1K).

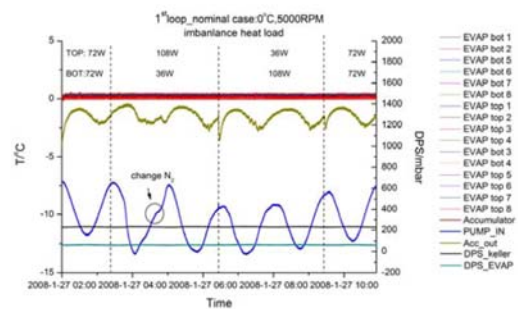

Figure 19: TTCS EM evaporator imbalance testing in nominal operating conditions (5000 rpm, SP=0 °C and simulated orbital environments)

In figure 18 a typical test result is shown for varying dissipating load on the evaporator, simulating switching on/off the Tracker segments. Even with power changes far above the Tracker electronics dissipation levels no instabilities were detected.

A more challenging test with similar results is shown in figure 19 where a large heat imbalance between the upper and lower evaporator branch is simulated. The evaporator temperature stability is however not affected. All Engineering Model and Qualification Model tests showed reliable performance in all operating conditions.

The final TTCS test will be the flight model testing with connected flight Tracker radiators during AMS02 thermal vacuum testing in ESA's Large Space Simulator.

### SPIN-OFF AND FUTURE DEVELOPMENTS

#### Spin-off

The selling points of mechanically pumped two-phase systems are:

- The possibility to locate the temperature control at a distant location (up to 100 meters) far away from the to be cooled item or instrument.
- The possibility to provide thermal control for distributed dissipative elements
- High temperature stability and isothermal behaviour
- Reliable straightforward operation and start-up

Special for CO<sub>2</sub> is the low liquid/vapour density ratio resulting in low evaporator pressure drops providing the possibility to implement tight thermal control in extremely confined areas.

Against the selling points mechanically pumped two-phase systems have the drawback of a moving part (pump) not preferred by space system designers in view of reliability and driver electronics mass (~0.9 kg). For CO<sub>2</sub> also the relative high freezing point (-55°C) gives design challenges for condenser design in cold space environments [5].

Because most drawbacks are of minor concern for terrestrial applications, the above listed selling points resulted in the implementation of a TTCS-like system in the Vertex Locator (Velo) instrument of the Large Hadron Collider (LHCb) by NIKHEF [9]. This 2.5 kW system is successfully implemented and tests showed more than satisfactory results. Currently the two other large CERN experiments ATLAS and CMS are considering a similar system for the upgrade of their inner detectors. This requires upscaling with a factor 1000 compared to the TTCS.

#### Space applications

The current commercial Spacecraft (S/C) are running to their thermal limits meaning that the radiator area is too small to provide enough cooling capacity. Recent requests of customers will force the industry to provide deployable radiators. Firstly this will be done with capillary pumped cooling systems but for S/C requiring stable temperatures or for future very dissipative telecommunication payloads (Q>9kW), two-phase mechanically pumped systems are advantageous and a competitive alternative to complex LHP-

HP networks. The first application of a 2-phase mechanically pumped loop is foreseen to cool an active antenna, requiring tight and stable temperature control. This is expected not earlier than 2015.

### CONCLUSIONS

An overview of the TTCS system and the system design considerations are presented. It is shown that a CO<sub>2</sub> two-phase mechanically pumped loop is capable of cooling the widely distributed Tracker front-end electronics. The TTCS system design, the development status and some typical test results are described. The Engineering model tests show stable temperature control in challenging orbital conditions. Currently the Flight Model TTCS component boxes, the FM condensers and FM evaporators are qualified and being integrated onto the AMS02 experiment. Launch is planned for July 2010.

### REFERENCES

1. AMS collaboration, The Alpha Magnetic Spectrometer (AMS) on the International Space Station, Part I, Results from the test flight on the Space Shuttle, Physics Reports, vol. 366/6 (Aug.2002), pp.331-404
2. Verlaat B., H. Boer Rookhuizen, A.A.M. Delil, A.A. Woering, E. Perrin, M. Pohl Feasibility Demonstration of a Mechanically Pumped Two-Phase CO<sub>2</sub> Cooling Loop for the AMS-2 Tracker Experiment, NLR-TP-2001-376.
3. van Es, J., G. van Donk, A. Pauw, B. Verlaat, C.A.M. Rens, J. Jaarsma, M.P.A.M. Brouwer, AMS02 Tracker Thermal Control System (TTCS) design, model and breadboard results, 34<sup>th</sup> Int. Conf. on Environmental Systems, Colorado Springs, SAE2004-01-2556 (2004)
4. Delil, A.A.M., A. Pauw, A.A. Woering, B. Verlaat, AMS-2 Tracker Thermal Control System: Design and Thermal Modelling of the Mechanically Pumped Two-Phase CO<sub>2</sub> Loop, Proc. STAIF-2003, Albuquerque, NM, USA.
5. van Donk, G., M. Bsibsi, A. Pauw, J. van Es, Testing of a Freeze-proof Condenser for the Tracker Thermal Control System on AMS-02, 37<sup>th</sup> Int. Conf. on Environmental Systems, Chicago, Illinois, USA, July 9-12, 2007
6. Huang, Z.C., Z.H. He, D.C. Mo, X.H. Sun, S.S. Lu, W.J. Xiao, A. Pauw, E. Laudi, J. van Es, Coupling Between an Accumulator and a Loop in a Mechanically Pumped Carbon Dioxide Two-Phase Loop, Microgravity Sci. Technol (2009) 21 (Suppl 1):S23-S29.
7. Sun, X.H., Z.H. He, Z.C. Huang, W.J. Xiao, X.M. Qi, A. Pauw, J. van Es, Analysis of Temperature Oscillations in Parallel Evaporators of a Carbon Dioxide Two-Phase Loop, Microgravity Sci. Technol (2009) 21 (Suppl 1):S299-S304.
8. Mo, D.C. Mo, W.-J. Xiao, Z.C. Huang, X.H. Sun, Y. Chen, S.S. Lu, T.X. Li, X.M. Qi, Z.X. Wang, A. Pauw, M. Bsibsi, C. Gargiulo, J. van Es, Z.H. He, Comparison of

Pressure Drop between Calculation and Experiment for a Two-phase Carbon Dioxide Loop, *Microgravity Sci. Technol* (2008) 20:183–186 DOI 10.1007/s12217-008-9019-2

9. B. Verlaat, A. Van Lysebetten, M. Van Beuzekom, CO<sub>2</sub> Cooling for the LHCB-VELO experiment at CERN, GL2008 8th IIF/IIR Gustav Lorentzen Conference on Natural Working Fluids, 7-10 September 2008, Copenhagen, Denmark

10. Delil, A.A.M., Research issues on Two-Phase Loops for Space Applications, NLR-TP-2000-703, Proc. ISAS Symp. On Space Flight Mechanics, Sagami-hara, Japan, 2000.

### ACRONYMS

3D	Three dimensional
ACC	Anti Coincidence Counter
AIDC	Aerospace Industrial Development Corporation (Taiwan)
AMS	Alpha Magnetic Spectrometer
APS	Absolute Pressure Sensor
ATLAS	A Toroidal LHC Apparatus
CAST	Chinese Academy of Space Technology (P.R. China)
CERN	European Organisation for Nuclear Research
CMS	Compact Muon Solenoid
CPL	Capillary Pumped Loop
ECAL	Electromagnetic Calorimeter
ESA	European Space Agency
FM	Flight Model
DPS	Differential Pressure Sensor
HP	Heat Pipe
HX	Heat Exchanger
H/W	Hardware
INFN	Istituto Nazionale Fisica Nucleare (Italy)
ISS	International Space Station
LHC	Large Hadron Collider
LHP	Loop Heat Pipe
MIT	Massachusetts Institute of Technology (USA)
MLI	Multi-Layer Insulation
NIKHEF	National Institute for Subatomic Physics (The Netherlands)
NLR	National Aerospace Laboratory (The Netherlands)
RICH	Ring-Imaging Cherenkov detector
SP	Set Point
SYSU	Sun Yat Sen University (P.R.China)
TOF	Time of Flight
TRD	Transition Radiator Detector
TTCS	Tracker Thermal Control System

### ACKNOWLEDGEMENT

The AMS02 introduction in this article is mainly based on the AMS02 web site written by Benjamin Monreal (MIT). (<http://cyclo.mit.edu/~bmonreal/frames.phys.html>)